

AXL F PWR 1H

Axioline F power module for the communications power U_{BUS} , max. 4 A

Data sheet
105688_en_02

© PHOENIX CONTACT 2016-03-02

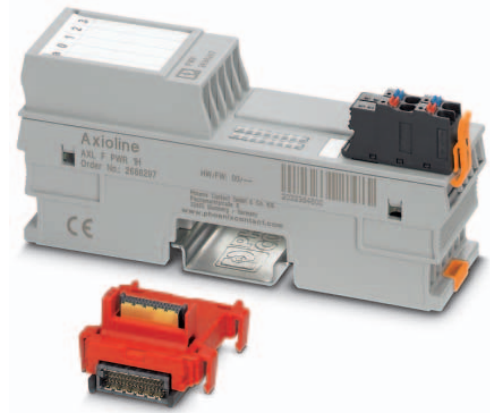

1 Description

The module is designed for use within an Axioline F station. If the maximum load of the bus coupler for the Axioline F local bus supply (communications power U_{BUS}) is reached, this module can be used to provide this voltage again. To this end, apply a 24 V DC voltage (U_L) to the module from which the (U_{BUS}) is generated.

Features

- Supply of the 24 V voltage U_L for generating the communications power U_{BUS}
- Diagnostic and status indicators



This module does not have a microprocessor and is therefore not a local bus device. It is not mapped to engineering tools.



NOTE: Malfunction

The power module only boosts the U_{BUS} voltage, if the corresponding red bus base module is snapped on and if the U_{BUS} voltage is present in the segment downstream of the power module.



This data sheet is only valid in association with the UM EN AXL F SYS INST user manual.



Make sure you always use the latest documentation. It can be downloaded from the product at phoenixcontact.net/products.

2	Table of contents	
1	Description	1
2	Table of contents	2
3	Ordering data	3
4	Technical data	3
5	Internal circuit diagram	5
6	Terminal point assignment.....	5
7	Connection example.....	5
8	Installation instructions	5
9	Local diagnostic and status indicators	6

3 Ordering data

Description	Type	Order No.	Pcs./Pkt.
Axioline F power module for the communications power UBus, max. 4 A (including bus base module and connector)	AXL F PWR 1H	2688297	1
Accessories	Type	Order No.	Pcs./Pkt.
Axioline F bus base module for power modules in housing type H (Replacement item)	AXL F BS H PWR	2702051	5
Axioline F short power connector (for e.g., AXL F BK ...) (Replacement item)	AXL CN S/UL	2701421	5
Zack marker strip for Axioline F (device labeling), in 2 x 20.3 mm pitch, unprinted, 25-section, for individual labeling with B-STIFT 0.8, X-PEN, or CMS-P1-PLOTTER (Marking)	ZB 20,3 AXL UNPRINTED	0829579	25
Zack marker strip, flat, in 10 mm pitch, unprinted, 10-section, for individual labeling with M-PEN 0,8, X-PEN, or CMS-P1-PLOTTER (Marking)	ZBF 10/5,8 AXL UNPRINTED	0829580	50
Insert label, Roll, white, unlabeled, can be labeled with: THERMOMARK ROLL, THERMOMARK ROLL X1, THERMOMARK X, THERMOMARK S1.1, Mounting type: snapped into marker carrier, Lettering field: 35 x 28 mm (Marking)	EMT (35X28)R	0801602	1
Documentation	Type	Order No.	Pcs./Pkt.
User manual, English, Axioline F: System and installation	UM EN AXL F SYS INST	-	-

4 Technical data

Dimensions (nominal sizes in mm)

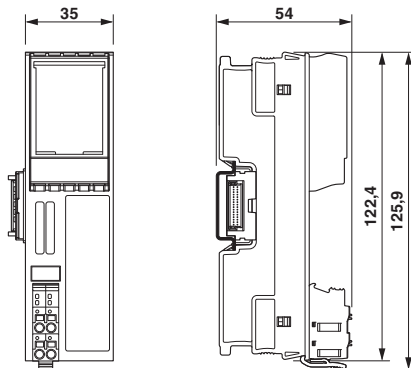

Width	35 mm
Height	126.1 mm
Depth	54 mm
Note on dimensions	The depth is valid when a TH 35-7.5 DIN rail is used (according to EN 60715).

General data

Color	traffic grey A RAL 7042
Weight	107 g (with connector and bus base module)
Ambient temperature (operation)	-25 °C ... 60 °C
Ambient temperature (storage/transport)	-40 °C ... 85 °C
Permissible humidity (operation)	5 % ... 95 % (non-condensing)
Permissible humidity (storage/transport)	5 % ... 95 % (non-condensing)

General data

Air pressure (operation)	70 kPa ... 106 kPa (up to 3000 m above sea level)
Air pressure (storage/transport)	70 kPa ... 106 kPa (up to 3000 m above sea level)
Degree of protection	IP20
Protection class	III, IEC 61140, EN 61140, VDE 0140-1
Mounting position	Any (no temperature derating)

Connection data

Designation	Axioline F connector
Connection method	Push-in connection
Conductor cross section solid / stranded	0.2 mm ² ... 1.5 mm ² / 0.2 mm ² ... 1.5 mm ²
Conductor cross section [AWG]	24 ... 16
Stripping length	8 mm



Please observe the information provided on conductor cross sections in the "Axioline F: system and installation" user manual.

Interface Axioline F local bus

Connection method	Bus base module
Transmission speed	100 MBit/s

Communications power

Supply of communications power U_L	24 V DC
Maximum permissible voltage range	19.2 V DC ... 30 V DC (including all tolerances, including ripple)
Current supply at U_{BUS}	max. 4 A
Current consumption from U_L	max. 1.2 A ($I_{BUS} = 4 A$; $U_L = 19,2 V$)
Power consumption at U_L	max. 22 W ($I_{BUS} = 4 A$)



NOTE: Damage to the electronics

Provide the module with an external fuse to protect it against polarity reversal. The power supply unit must be able to supply four times the nominal current of the external fuse, to ensure that it trips in the event of an error.

Error messages to the higher level control or computer system

None

Mechanical tests

Vibration resistance in acc. with EN 60068-2-6/IEC 60068-2-6	5g
Shock in acc. with EN 60068-2-27/IEC 60068-2-27	30g
Continuous shock according to EN 60068-2-27/IEC 60068-2-27	10g

Conformance with EMC Directive 2004/108/EC (valid until 19.04.2016) / 2014/30/EU (valid from 20.04.2016)

Noise immunity test in accordance with EN 61000-6-2

Electrostatic discharge (ESD) EN 61000-4-2/IEC 61000-4-2	Criterion B, 6 kV contact discharge, 8 kV air discharge
Electromagnetic fields EN 61000-4-3/IEC 61000-4-3	Criterion A; Field intensity: 10 V/m
Fast transients (burst) EN 61000-4-4/IEC 61000-4-4	Criterion B, 2 kV
Transient overvoltage (surge) EN 61000-4-5/IEC 61000-4-5	Criterion B, DC supply lines: $\pm 0.5 kV/\pm 0.5 kV$ (symmetrical/asymmetrical)
Conducted interference EN 61000-4-6/IEC 61000-4-6	Criterion A; Test voltage 10 V

Noise emission test according to EN 61000-6-3

Radio interference properties EN 55022	Class B
--	---------

Approvals

For the latest approvals, please visit phoenixcontact.net/products.

5 Internal circuit diagram

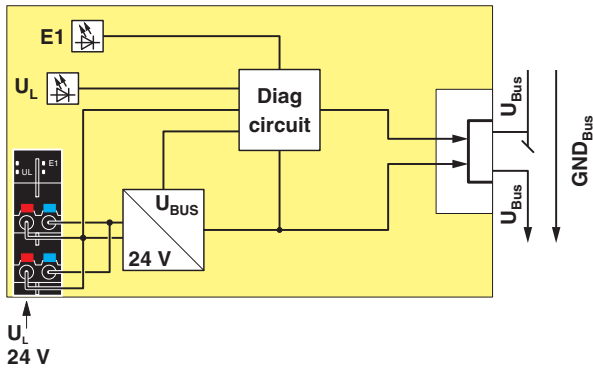





Figure 1 Basic circuit diagram

Key:

- Local bus Axioline F local bus
(hereinafter referred to as local bus)
- Diag circuit Diagnostics circuit
-  Power supply unit
-  LED
-  Electrically isolated areas

The module disconnects the incoming voltage routing for U_{BUS} and re-establishes it for the subsequent modules.

6 Terminal point assignment



Figure 2 Terminal point assignment

Terminal point	Color	Assignment	
Supply voltage input			
a1, a2	Red	24 V DC (U_L)	Supply of the logic voltage (internally jumpered)
b1, b2	Blue	GND	Reference potential of the supply voltage (internally jumpered)

7 Connection example

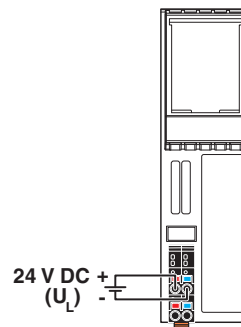

Figure 3 Connection of the cables

8 Installation instructions



NOTE: Malfunction

Ensure you insert the power module into the associated bus base module!

If you use an incorrect bus base module both LEDs will illuminate red and the power module will be inoperative.

The bus base module belonging to the power module is red. As such, it differs from all other bus base modules.

The bus base module is coded in such a way that it cannot accommodate any other modules.

9 Local diagnostic and status indicators

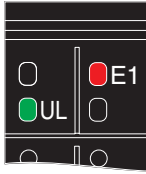

Figure 4 Local diagnostic and status indicators

Designation	Color	Meaning	State	Description
UL	Green/red	U _{Logic}	Green ON	Communications power U_{Bus} is present.
			Red ON	Communications power U_{Bus} is not present or overloaded.
				Communications power U_{Bus} downstream of the power module is not present.
OFF	Communications power supply not present.			
E1	Red	Error	Red ON	Module has been snapped on to the wrong bus base.
			OFF	Module has been snapped on to the right bus base.