

1

2

3

4

5

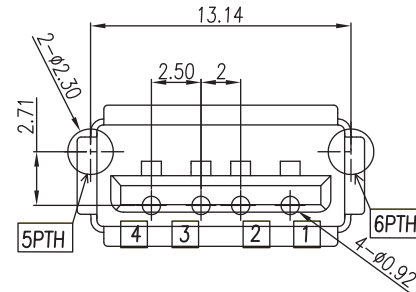
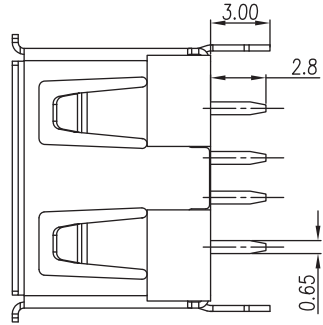

PCB LAYOUT - COMPONENT VIEW
RECOMMENDED PCB THICKNESS : 1.2 mm

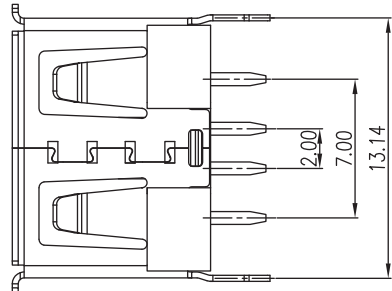
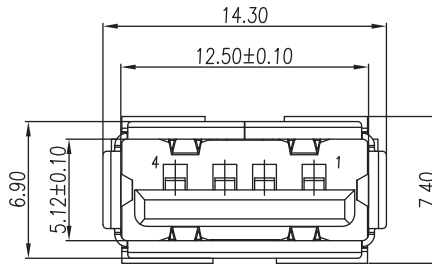
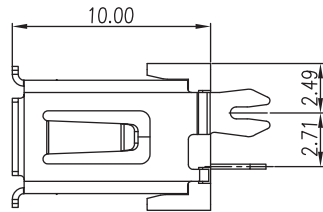
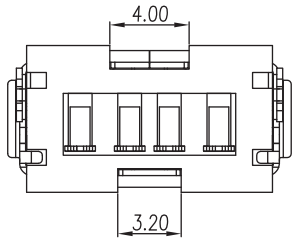

TECHNICAL CHARACTERISTICS

MATERIAL
INSULATOR: PBT
FLAMMABILITY RATING: UL94-V0
COLOR: WHITE
CONTACT MATERIAL: COPPER ALLOY
CONTACT PLATING: GOLD OVER Ni
COVER MATERIAL: BRASS
COVER PLATING: Ni
QUALITY CLASS: 1 500 MATING CYCLES

ENVIRONMENTAL
OPERATING TEMPERATURE: -55°C UP TO +85°C
COMPLIANCE: LEAD FREE & ROHS

ELECTRICAL
CURRENT RATING: 1.5A MAX
WORKING VOLTAGE: 30 VAC MAX
WITHSTANDING VOLTAGE: 500 VAC/MIN
INSULATION RESISTANCE: > 1000 MΩ
CONTACT RESISTANCE: 30 mΩ MAX

MECHANICAL
INSERTION FORCE: 35 N MAX
EXTRACTION FORCE: 10 N/MIN

SOLDERING
JEDEC LEAD FREE WAVE SOLDERING PROCESS

PACKAGING
TRAY

A

B

C

RoHS Compliant

G			
F			
E			
D			
C			
B			
A	10-AUG-15	PDF	AK
REV	DATE	FILE	BY

PROJECTION:



APPROVAL: NPr

GENERAL TOLERANCE

.X = +/- 0.2
.XX = +/- 0.15

UNIT: MM

SCALE:

SHEET: 1/3

DRAW: AK



DESCRIPTION: USB TYPE A VERTICAL THT - SHORT TYPE

WERI PART NO: 614 004 185 023

SIZE

A4

D

1

2

3

4

5

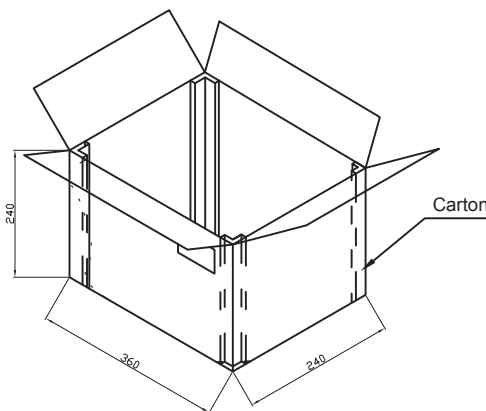
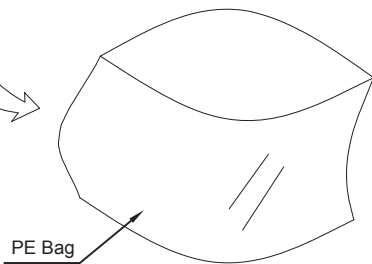
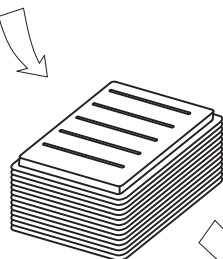
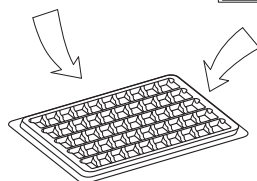
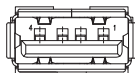
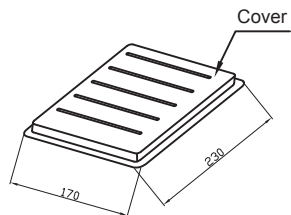

50 pcs/tray
40 trays/carton
2000 pcs/carton

A

B

C

RoHS Compliant

G			
F			
E			
D			
C			
B			
A		PDF	
REV	DATE	FILE	BY

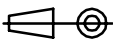
PROJECTION:

GENERAL TOLERANCE
 .X = +/- 0.2
 .XX = +/- 0.15



APPROVAL: NPr

UNIT: MM
 SCALE:
 SHEET: 2/3
 DRAW: AK

DESCRIPTION: USB TYPE A VERTICAL THT - SHORT TYPE
 WERI PART NO: 614 004 185 023

SIZE
A4

D

1

2

3

4

5

Cautions and Warnings:

This electronic component is designed and developed with the intention for use in general electronics equipments.

Before incorporating the components into any equipments in the field such as aerospace, aviation, nuclear control, submarine, transportation, (automotive control, train control, ship control), transportation signal, disaster prevention, medical, public information network etc. where higher safety and reliability are especially required or if there is possibility of direct damage or injury to human body, Würth Elektronik must be asked for a written approval.

In addition, even electronic component in general electronic equipments, when used in electrical circuits that require high safety, reliability functions or performance, the sufficient reliability evaluation-check for the safety must be performed before by the user before usage.

A

B

C

RoHS Compliant

PROJECTION:



GENERAL TOLERANCE

.X = +/- 0.2

.XX = +/- 0.15



APPROVAL: JC

UNIT: MM

SCALE:

SHEET: 3/3

DRAW: QL



DESCRIPTION: DISCLAIMER

WERI PART NO: DISCLAIMER

SIZE

A4

D

G				PROJECTION: 	GENERAL TOLERANCE .X = +/- 0.2 .XX = +/- 0.15		DESCRIPTION: DISCLAIMER	SIZE A4	
F									
E									
D									
C				APPROVAL: JC	UNIT: MM		DESCRIPTION: DISCLAIMER	SIZE A4	
B					SCALE:				
A	10-SEP-14	PDF	QL		SHEET: 3/3				WERI PART NO: DISCLAIMER
REV	DATE	FILE	BY		DRAW: QL				