

## OPA355-Q1 200-MHz CMOS Operational Amplifier With Shutdown

### 1 Features

- Qualified for Automotive Applications
- AEC-Q100 Qualified With the Following Results
  - Device Temperature Grade 1:  $-40^{\circ}\text{C}$  to  $125^{\circ}\text{C}$  Ambient Operating Temperature
  - Device HBM ESD Classification Level 2
  - Device CDM ESD Classification Level C4B
- Unity-Gain Bandwidth: 450 MHz
- Wide Bandwidth: 200 MHz GBW
- High Slew Rate: 360 V/ $\mu\text{s}$
- Low Noise: 5.8 nV/ $\sqrt{\text{Hz}}$
- Excellent Video Performance:
  - Differential Gain: 0.02%
  - Differential Phase:  $0.05^{\circ}$  0.1 dB
  - Gain Flatness: 75 MHz
- Input Range Includes Ground
- Rail-to-Rail Output (within 100 mV)
- Low Input Bias Current: 3 pA
- Low Shutdown Current: 3.4  $\mu\text{A}$
- Enable and Disable Time: 100 ns and 30 ns
- Thermal Shutdown
- Single-Supply Operating Range: 2.5 to 5.5 V
- *MicroSIZE* Packages

### 2 Applications

- Automotive
- Active Filters
- High-Speed Integrators
- Analog-to-Digital Converter (ADC) Input Buffers
- Digital-to-Analog Converter (DAC) Output Amplifiers

### 3 Description

The OPA355-Q1 device is a high-speed, voltage-feedback CMOS operational amplifier designed for applications requiring wide bandwidth. The OPA355-Q1 device is unity-gain stable and can drive large output currents. In addition, the OPA355-Q1 device has a digital shutdown (enable) function. This feature provides power saving during idle periods and places the output in a high-impedance state to support output multiplexing. The differential gain is 0.02% and the differential phase is  $0.05^{\circ}$ . The quiescent current is 8.3 mA per channel.

The OPA355-Q1 device is optimized for operation on single supply or dual supplies as low as 2.5 V ( $\pm 1.25$  V) and up to 5.5 V ( $\pm 2.75$  V). The common-mode input range for the OPA355-Q1 device extends 100 mV below ground and up to 1.5 V from  $V+$ . The output swing is within 100 mV of the rails, supporting wide dynamic range.

The OPA355-Q1 device is available in a single SOT23-6 package and is specified over the extended  $-40^{\circ}\text{C}$  to  $125^{\circ}\text{C}$  range.

#### Device Information<sup>(1)</sup>

| PART NUMBER | PACKAGE    | BODY SIZE (NOM)   |
|-------------|------------|-------------------|
| OPA355-Q1   | SOT-23 (6) | 2.90 mm x 1.60 mm |

(1) For all available packages, see the orderable addendum at the end of the datasheet.

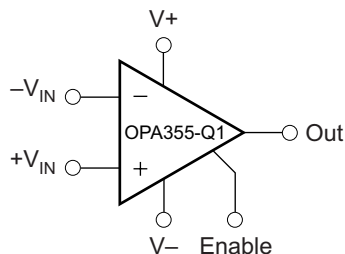

## Table of Contents

|  |          |  |           |
|--|----------|--|-----------|
| <b>1 Features</b> .....                        | <b>1</b> | <b>8 Detailed Description</b> .....                              | <b>11</b> |
| <b>2 Applications</b> .....                    | <b>1</b> | 8.1 Feature Description .....                                    | 11        |
| <b>3 Description</b> .....                     | <b>1</b> | <b>9 Application and Implementation</b> .....                    | <b>12</b> |
| <b>4 Revision History</b> .....                | <b>2</b> | 9.1 Application Information .....                                | 12        |
| <b>5 Device Comparison Table</b> .....         | <b>3</b> | <b>10 Layout</b> .....   | <b>12</b> |
| <b>6 Pin Configuration and Functions</b> ..... | <b>3</b> | 10.1 Layout Guidelines .....                                     | 12        |
| <b>7 Specifications</b> .....                  | <b>3</b> | <b>11 Device and Documentation Support</b> .....                 | <b>13</b> |
| 7.1 Absolute Maximum Ratings .....             | 3        | 11.1 Trademarks .....  | 13        |
| 7.2 Handling Ratings .....                     | 3        | 11.2 Electrostatic Discharge Caution .....                       | 13        |
| 7.3 Thermal Information .....                  | 4        | 11.3 Glossary .....  | 13        |
| 7.4 Electrical Characteristics .....           | 4        | <b>12 Mechanical, Packaging, and Orderable Information</b> ..... | <b>13</b> |
| 7.5 Typical Characteristics .....              | 6        |  |           |

## 4 Revision History

| Changes from Revision A (December 2013) to Revision B                               | Page |
|---|------|
| • Changed device status from <i>Product Preview</i> to <i>Production Data</i> ..... | 1    |

## 5 Device Comparison Table

| OPA355-Q1 RELATED PRODUCTS | FEATURES  |
|----------------------------|---|
| OPA356                     | 200-MHz, Rail-to-Rail Output, CMOS, No Shutdown |
| OPAx350                    | 38-MHz, Rail-to-Rail Input and Output, CMOS     |
| OPAx631                    | 75-MHz, Rail-to-Rail Output                     |
| OPAx634                    | 150-MHz, Rail-to-Rail Output                    |
| THS412x                    | Differential Input and Output, 3.3-V Supply     |

## 6 Pin Configuration and Functions

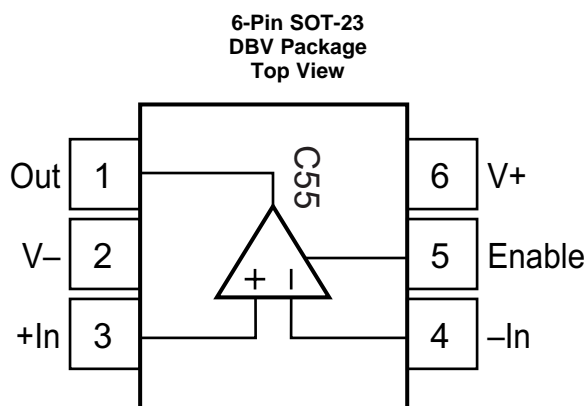

(1) Pin 1 of the SOT23-6 is determined by orienting the package marking as indicated in the diagram.

## 7 Specifications

### 7.1 Absolute Maximum Ratings

over operating free-air temperature range (unless otherwise noted)<sup>(1)</sup>

|  |          | MIN        | MAX        | UNIT |
|--|----------|------------|------------|------|
| Supply voltage                           | V+ to V- |            | 7.5        | V    |
| Signal input terminals                   | Voltage  | (V-) - 0.5 | (V+) + 0.5 | V    |
|  | Current  |            | 10         | mA   |
| Output short circuit <sup>(2)</sup>      |          | Continuous |            |      |
| Operating temperature                    |          | -55        | 150        | °C   |
| Junction Temperature                     |          |            | 160        | °C   |
| Lead temperature (soldering, 10 seconds) |          |            | 300        | °C   |

(1) Stresses above *absolute maximum ratings* may cause permanent damage. Exposure to absolute maximum conditions for extended periods may degrade device reliability. These are stress ratings only, and functional operation of the device at these or any other conditions beyond those specified is not implied.

(2) Short-circuit to ground, one amplifier per package.

### 7.2 Handling Ratings

|                    |                           | MIN   | MAX                          | UNIT |     |
|--------------------|---------------------------|---|------------------------------|------|-----|
| T <sub>stg</sub>   | Storage temperature range | -65   | 150                          | °C   |     |
| V <sub>(ESD)</sub> | Electrostatic discharge   | Human body model (HBM), per AEC Q100-002 <sup>(1)</sup> | 2000                         | V    |     |
|                    |                           | Charged device model (CDM), per AEC Q100-011            | Corner pins (1, 3, 4, and 6) |      | 750 |
|                    |                           |   | Other pins                   |      | 500 |

(1) AEC Q100-002 indicates HBM stressing is done in accordance with the ANSI/ESDA/JEDEC JS-001 specification.

### 7.3 Thermal Information

| THERMAL METRIC <sup>(1)</sup> |  | DBV<br>6 PINS | UNIT |
|-------------------------------|--|---------------|------|
| R <sub>θJA</sub>              | Junction-to-ambient thermal resistance       | 187.3         | °C/W |
| R <sub>θJC(top)</sub>         | Junction-to-case (top) thermal resistance    | 126.5         |      |
| R <sub>θJB</sub>              | Junction-to-board thermal resistance         | 32.6          |      |
| Ψ <sub>JT</sub>               | Junction-to-top characterization parameter   | 24.1          |      |
| Ψ <sub>JB</sub>               | Junction-to-board characterization parameter | 32.1          |      |
| R <sub>θJC(bot)</sub>         | Junction-to-case (bottom) thermal resistance | N/A           |      |

(1) For more information about traditional and new thermal metrics, see the *IC Package Thermal Metrics* application report, [SPRA953](#).

### 7.4 Electrical Characteristics

V<sub>S</sub> = 2.7 V to 5.5 V single supply. At T<sub>A</sub> = 25°C, R<sub>F</sub> = 604 Ω, R<sub>L</sub> = 150Ω, and connected to V<sub>S</sub> / 2, unless otherwise noted.

| PARAMETER                  | TEST CONDITIONS                          | T <sub>A</sub> = 25°C  |                         |            | T <sub>A</sub> = -40°C to 125°C |     |     | UNIT        |
|----------------------------|--|--|-------------------------|------------|---------------------------------|-----|-----|-------------|
|                            |  | MIN  | TYP                     | MAX        | MIN                             | TYP | MAX |             |
| <b>OFFSET VOLTAGE</b>      |  |  |                         |            |                                 |     |     |             |
| V <sub>OS</sub>            | Input offset voltage                     | V <sub>S</sub> = 5 V   | ±2                      | ±9         |                                 | ±15 |     | mV          |
| DV <sub>OS</sub> /dT       | Input offset voltage versus temperature  |  |                         |            |                                 | ±7  |     | μV/°C       |
| PSRR                       | Input offset voltage versus power supply | V <sub>S</sub> = 2.7 to 5.5 V, V <sub>CM</sub> = V <sub>S</sub> / 2 – 0.15 V | ±80                     | ±350       |                                 |     |     | μV/V        |
| <b>INPUT BIAS CURRENT</b>  |  |  |                         |            |                                 |     |     |             |
| I <sub>B</sub>             | Input bias current                       |  | 3                       | ±50        |                                 |     |     | pA          |
| I <sub>OS</sub>            | Input offset current                     |  | ±1                      | ±50        |                                 |     |     | pA          |
| <b>NOISE</b>               |  |  |                         |            |                                 |     |     |             |
| e <sub>n</sub>             | Input noise voltage density              | f = 1 MHz  | 5.8                     |            |                                 |     |     | nV/√Hz      |
| i <sub>n</sub>             | Current noise density                    | f = 1 MHz  | 50                      |            |                                 |     |     | fA/√Hz      |
| <b>INPUT VOLTAGE RANGE</b> |  |  |                         |            |                                 |     |     |             |
| V <sub>CM</sub>            | Common-mode voltage range                |  | (V-) – 0.1              | (V+) – 1.5 |                                 |     |     | V           |
| CMRR                       | Common-mode rejection ratio              | V <sub>S</sub> = 5.5 V, -0.1 V < V <sub>CM</sub> < 4 V                       | 66                      | 80         | 66                              |     |     | dB          |
| <b>INPUT IMPEDANCE</b>     |  |  |                         |            |                                 |     |     |             |
|                            | Differential                             |  | 10 <sup>13</sup>    1.5 |            |                                 |     |     | Ω    pF     |
|                            | Common-mode                              |  | 10 <sup>13</sup>    1.5 |            |                                 |     |     | Ω    pF     |
| <b>OPEN-LOOP GAIN</b>      |  |  |                         |            |                                 |     |     |             |
|                            | Open-loop gain                           | V <sub>S</sub> = 5 V, 0.3 V < V <sub>O</sub> < 4.7 V                         | 84                      | 92         | 80                              |     |     | dB          |
| <b>FREQUENCY RESPONSE</b>  |  |  |                         |            |                                 |     |     |             |
| f <sub>-3dB</sub>          | Small-signal bandwidth                   | G = 1, V <sub>O</sub> = 100 mVp-p, R <sub>F</sub> = 0 Ω                      | 450                     |            |                                 |     |     | MHz         |
|                            |  | G = 2, V <sub>O</sub> = 100 mVp-p, R <sub>L</sub> = 50 Ω                     | 100                     |            |                                 |     |     | MHz         |
|                            |  | G = 2, V <sub>O</sub> = 100 mVp-p, R <sub>L</sub> = 150 Ω                    | 170                     |            |                                 |     |     | MHz         |
|                            |  | G = 2, V <sub>O</sub> = 100 mVp-p, R <sub>L</sub> = 1 kΩ                     | 200                     |            |                                 |     |     | MHz         |
| GBW                        | Gain-bandwidth product                   | G = 10, R <sub>L</sub> = 1 kΩ  | 200                     |            |                                 |     |     | MHz         |
| f <sub>0.1dB</sub>         | Bandwidth for 0.1-dB gain flatness       | G = 2, V <sub>O</sub> = 100 mVp-p, R <sub>F</sub> = 560 Ω                    | 75                      |            |                                 |     |     | MHz         |
| SR                         | Slew rate                                | V <sub>S</sub> = 5 V, G = 2, 4-V output step                                 | 300                     | -360       |                                 |     |     | V/μs        |
| Rise and fall time         |  | G = 2, V <sub>O</sub> = 200 mVp-p, 10% to 90%                                | 2.4                     |            |                                 |     |     | ns          |
|                            |  | G = 2, V <sub>O</sub> = 2 Vp-p, 10% to 90%                                   | 8                       |            |                                 |     |     | ns          |
| Settling time              | 0.1%                                     | V <sub>S</sub> = 5 V, G = 2, 2-V output step                                 | 30                      |            |                                 |     |     | ns          |
|                            | 0.01%                                    | V <sub>S</sub> = 5 V, G = 2, 2-V output step                                 | 120                     |            |                                 |     |     | ns          |
| Overload recovery time     |  | V <sub>I</sub> × G = V <sub>S</sub>  | 8                       |            |                                 |     |     | ns          |
| Harmonic distortion        | Second harmonic                          | G = 2, f = 1 MHz, V <sub>O</sub> = 2 Vp-p, R <sub>L</sub> = 200 Ω            | -81                     |            |                                 |     |     | dBc         |
|                            | Third harmonic                           | G = 2, f = 1 MHz, V <sub>O</sub> = 2 Vp-p, R <sub>L</sub> = 200 Ω            | -93                     |            |                                 |     |     | dBc         |
| Differential gain error    |  | NTSC, R <sub>L</sub> = 150 Ω   | 0.02%                   |            |                                 |     |     |             |
| Differential phase error   |  | NTSC, R <sub>L</sub> = 150 Ω   | 0.05                    |            |                                 |     |     | degrees (°) |

## Electrical Characteristics (continued)

$V_S = 2.7\text{ V}$  to  $5.5\text{ V}$  single supply. At  $T_A = 25^\circ\text{C}$ ,  $R_F = 604\ \Omega$ ,  $R_L = 150\ \Omega$ , and connected to  $V_S / 2$ , unless otherwise noted.

| PARAMETER                        |                                     | TEST CONDITIONS  | $T_A = 25^\circ\text{C}$                |     |          | $T_A = -40^\circ\text{C to } 125^\circ\text{C}$ |     |     | UNIT     |                  |                  |
|----------------------------------|-------------------------------------|--|---|-----|----------|---|-----|-----|----------|------------------|------------------|
|                                  |                                     |  | MIN                                     | TYP | MAX      | MIN   | TYP | MAX |          |                  |                  |
| <b>OUTPUT</b>                    |                                     |  |   |     |          |   |     |     |          |                  |                  |
| Voltage output swing from rail   |                                     | $V_S = 5\text{ V}$ , $R_L = 150\ \Omega$ , $A_{OL} > 84\text{ dB}$ |   |     | 0.2      | 0.3   |     |     |          | V                |                  |
|                                  |                                     |  |   |     | 0.1      |   |     |     | V        |                  |                  |
| $I_O$                            | Output current <sup>(1)</sup>       | Continuous   |   |     | $\pm 60$ |   |     |     | mA       |                  |                  |
|                                  |                                     | Peak   | $V_S = 5\text{ V}$                      |     |          | $\pm 100$                                       |     |     |          | mA               |                  |
|                                  | $V_S = 3\text{ V}$                  |  |   |     | $\pm 80$ |   |     |     | mA       |                  |                  |
| Closed-loop output impedance     |                                     | $f < 100\text{ kHz}$   |   |     | 0.02     |   |     |     | $\Omega$ |                  |                  |
| <b>POWER SUPPLY</b>              |                                     |  |   |     |          |   |     |     |          |                  |                  |
| $V_S$                            | Specified voltage range             |  | 2.7                                     |     | 5.5      |   |     |     | V        |                  |                  |
|                                  | Operating voltage range             |  | 2.5 to 5.5                              |     |          |   |     |     | V        |                  |                  |
| $I_Q$                            | Quiescent current (per amplifier)   |  | $V_S = 5\text{ V}$ , enabled; $I_O = 0$ |     | 8.3      |   | 11  |     | 14       | mA               |                  |
| <b>SHUTDOWN</b>                  |                                     |  |   |     |          |   |     |     |          |                  |                  |
| Disabled                         | Logic-LOW threshold <sup>(2)</sup>  |  |   | 0.8 |          |   |     |     |          | V                |                  |
| Enabled                          | Logic-HIGH threshold <sup>(2)</sup> | 2  |   |     |          |   |     |     |          | V                |                  |
| Enable time                      |                                     |  |   | 100 |          |   |     |     |          | ns               |                  |
| Disable time                     |                                     |  |   | 30  |          |   |     |     |          | ns               |                  |
| Shutdown current (per amplifier) |                                     | $V_S = 5\text{ V}$ , disabled                                      |   | 3.4 |          |   |     |     |          | $\mu\text{A}$    |                  |
| <b>THERMAL SHUTDOWN</b>          |                                     |  |   |     |          |   |     |     |          |                  |                  |
| Junction Temperature             | Shutdown                            |  |   |     | 160      |   |     |     |          |                  | $^\circ\text{C}$ |
|                                  | Reset from Shutdown                 |  |   |     | 140      |   |     |     |          |                  | $^\circ\text{C}$ |
| <b>TEMPERATURE RANGE</b>         |                                     |  |   |     |          |   |     |     |          |                  |                  |
| Specified Range                  |                                     |  |   | -40 |          | 125   |     |     |          | $^\circ\text{C}$ |                  |
| Operating Range                  |                                     |  |   | -55 |          | 150   |     |     |          | $^\circ\text{C}$ |                  |
| Storage Range                    |                                     |  |   | -65 |          | 150   |     |     |          | $^\circ\text{C}$ |                  |

(1) See the *Output Voltage Swing vs Output Current* (Figure 21 and Figure 23) in the *Typical Characteristics* section.

(2) Logic LOW and HIGH levels are CMOS logic compatible. They are referenced to  $V_-$ .

## 7.5 Typical Characteristics

At  $T_A = 25^\circ\text{C}$ ,  $V_S = 5\text{ V}$ ,  $G = 2$ ,  $R_F = 604\ \Omega$ , and  $R_L = 150\ \Omega$  connected to  $V_S / 2$ , unless otherwise noted.

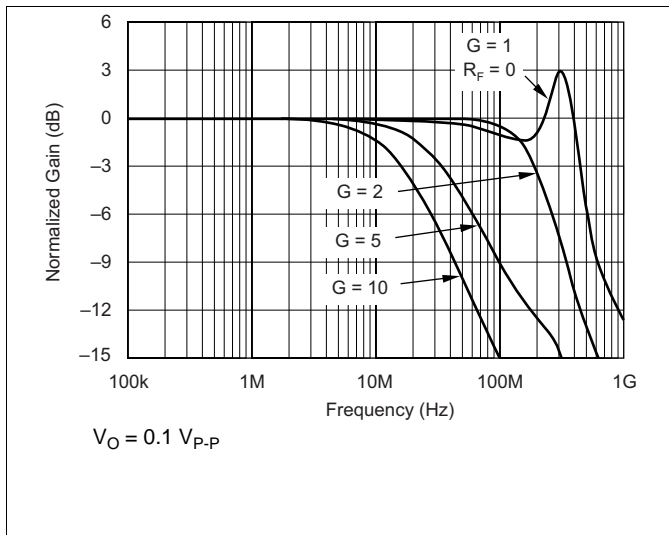

Figure 1. Non-Inverting Small-Signal Frequency Response

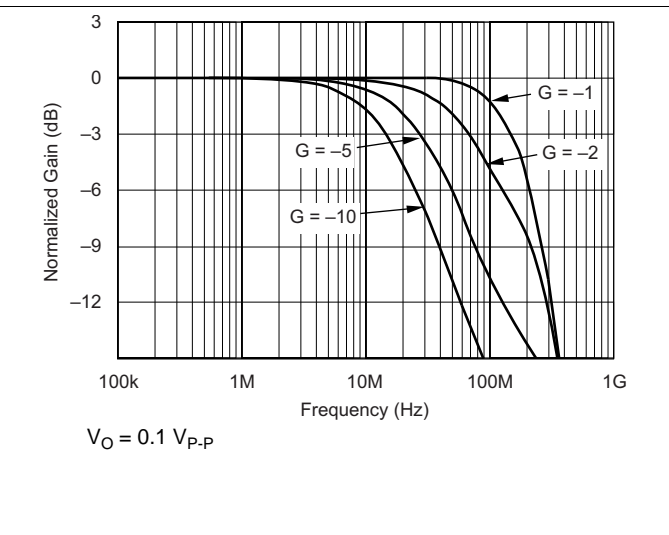

Figure 2. Inverting Small-Signal Frequency Response

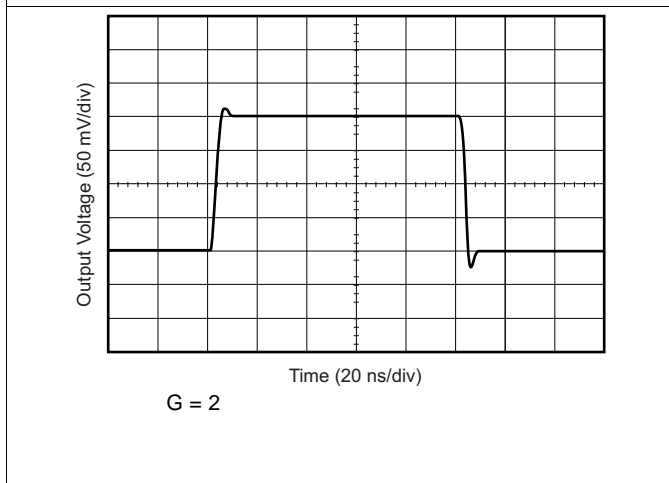

Figure 3. Non-Inverting Small-Signal Step Response

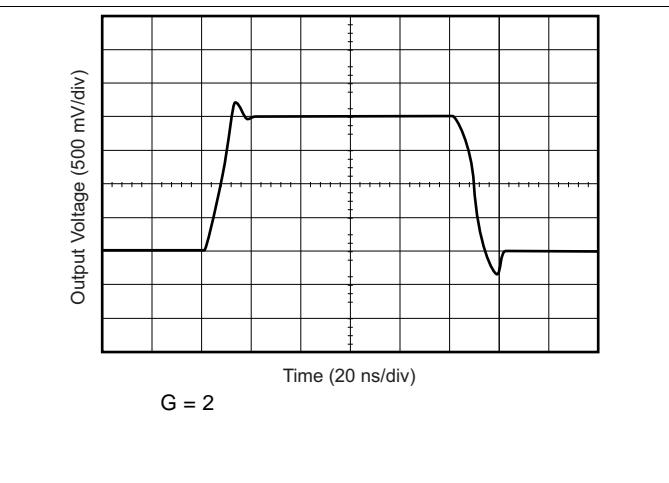

Figure 4. Non-Inverting Large-Signal Step Response

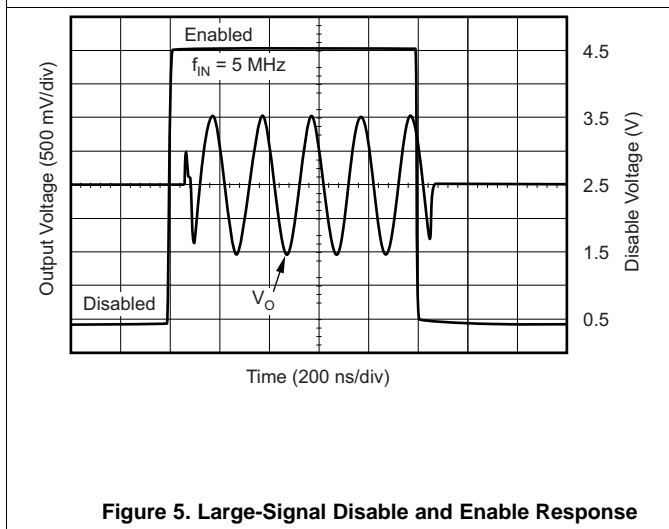

Figure 5. Large-Signal Disable and Enable Response

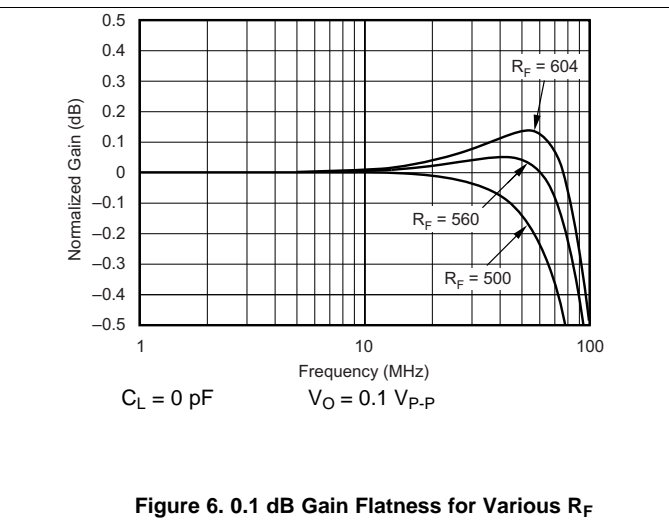

Figure 6. 0.1 dB Gain Flatness for Various  $R_F$

Typical Characteristics (continued)

At  $T_A = 25^\circ\text{C}$ ,  $V_S = 5\text{ V}$ ,  $G = 2$ ,  $R_F = 604\ \Omega$ , and  $R_L = 150\ \Omega$  connected to  $V_S / 2$ , unless otherwise noted.

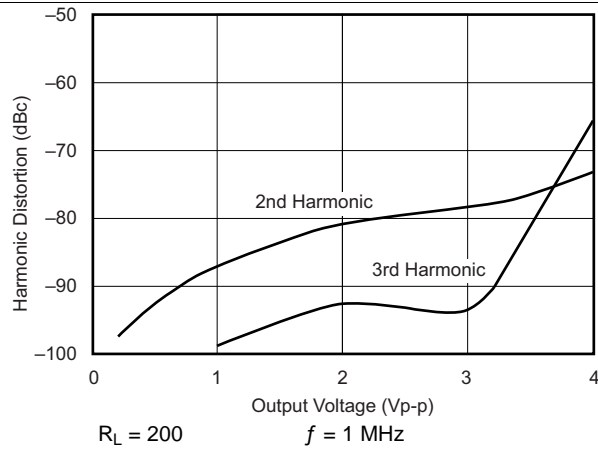

Figure 7. Harmonic Distortion vs Output Voltage

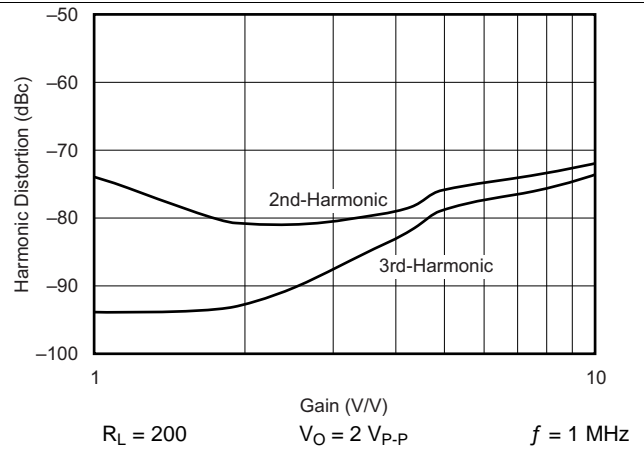

Figure 8. Harmonic Distortion vs Non-Inverting Gain

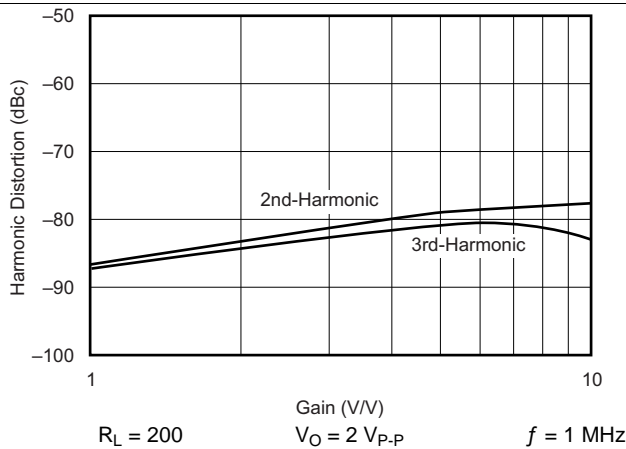

Figure 9. Harmonic Distortion vs Inverting Gain

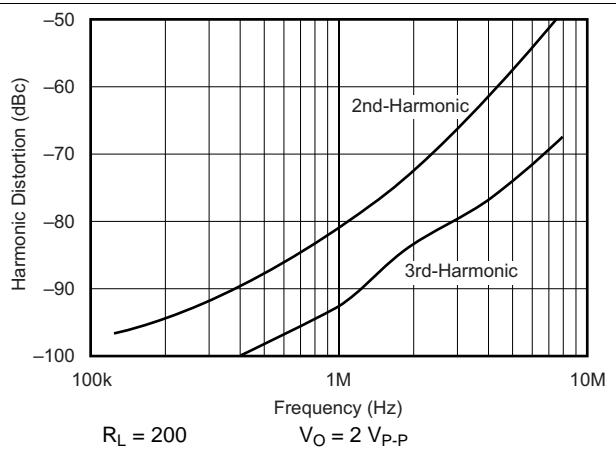

Figure 10. Harmonic Distortion vs Frequency

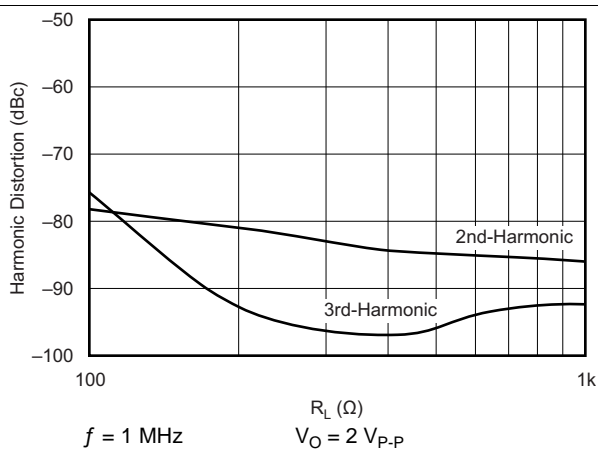

Figure 11. Harmonic Distortion vs Load Resistance

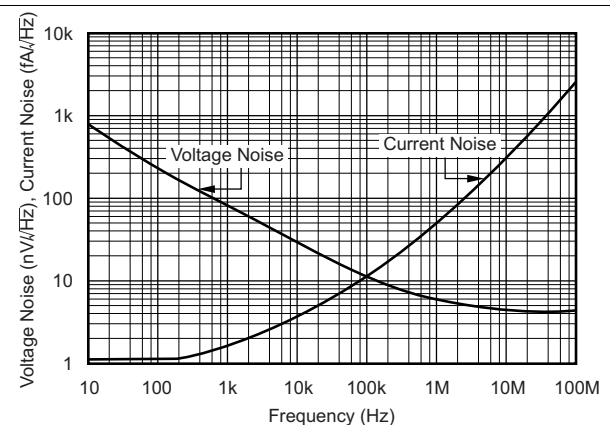
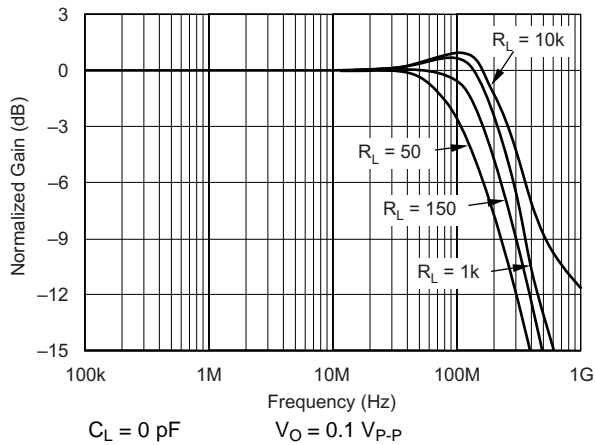

Figure 12. Input Voltage and Current Noise Spectral Density vs Frequency

**Typical Characteristics (continued)**

At  $T_A = 25^\circ\text{C}$ ,  $V_S = 5\text{ V}$ ,  $G = 2$ ,  $R_F = 604\ \Omega$ , and  $R_L = 150\ \Omega$  connected to  $V_S / 2$ , unless otherwise noted.



**Figure 13. Frequency Response for Various  $R_L$**

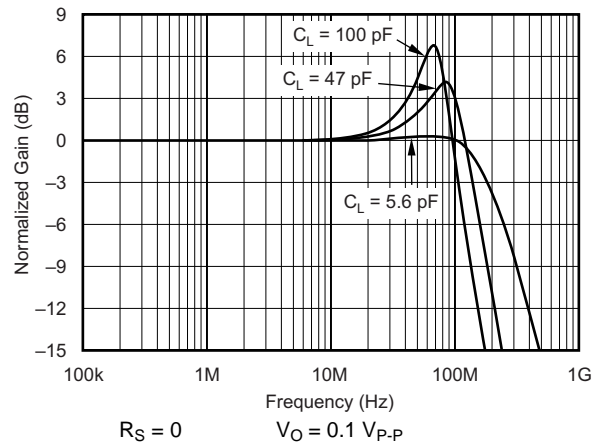

**Figure 14. Frequency Response for Various  $C_L$**

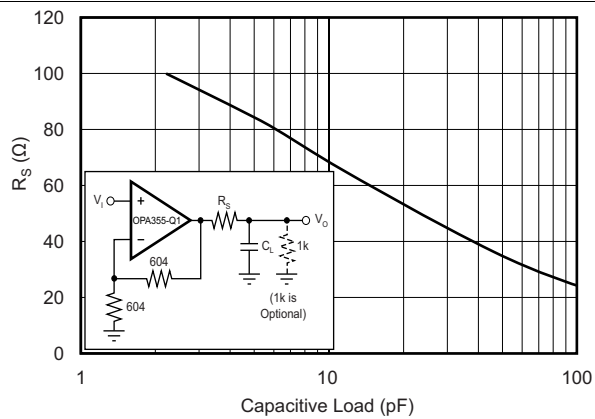

**Figure 15. Recommended  $R_S$  vs Capacitive Load**

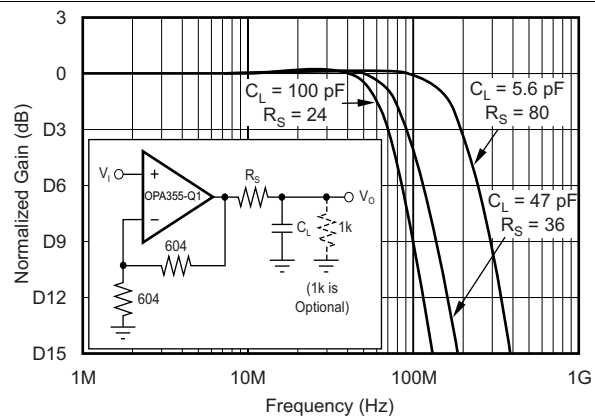

**Figure 16. Frequency Response vs Capacitive Load**

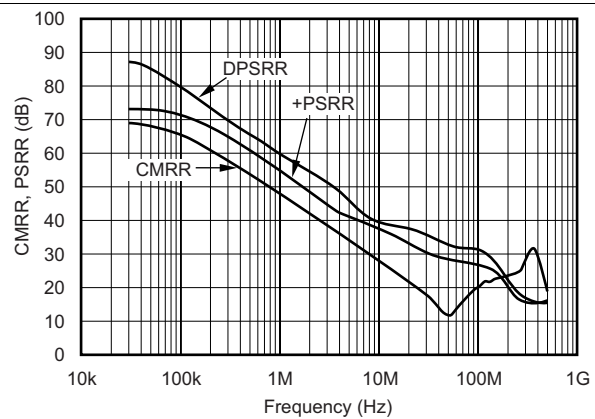

**Figure 17. Common-Mode Rejection Ratio and Power-Supply Rejection Ratio vs Frequency**

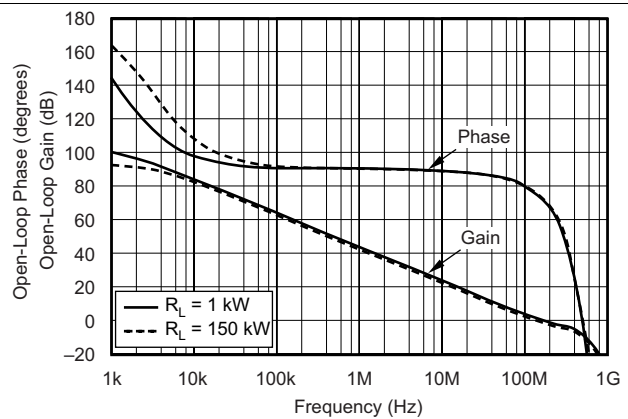

**Figure 18. Open-Loop Gain and Phase**



Typical Characteristics (continued)

At  $T_A = 25^\circ\text{C}$ ,  $V_S = 5\text{ V}$ ,  $G = 2$ ,  $R_F = 604\ \Omega$ , and  $R_L = 150\ \Omega$  connected to  $V_S / 2$ , unless otherwise noted.

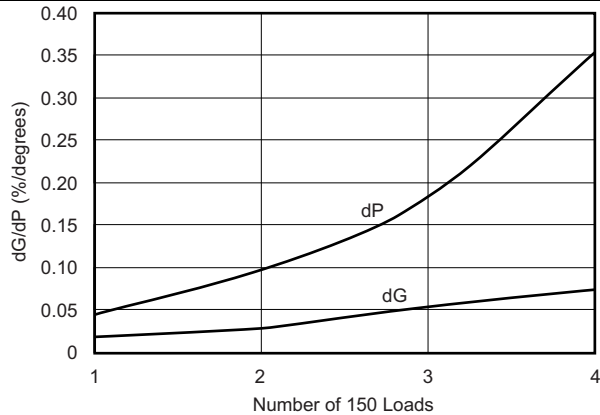

Figure 19. Composite Video Differential Gain and Phase

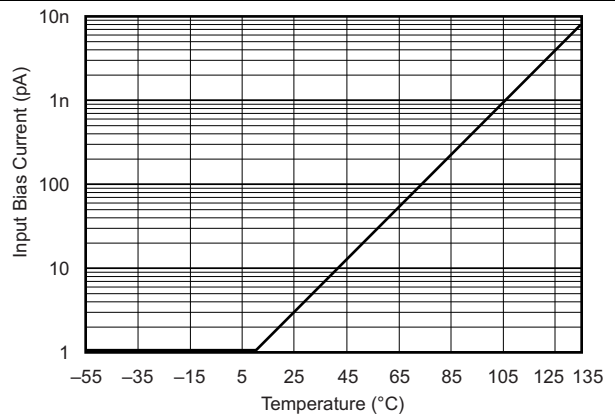
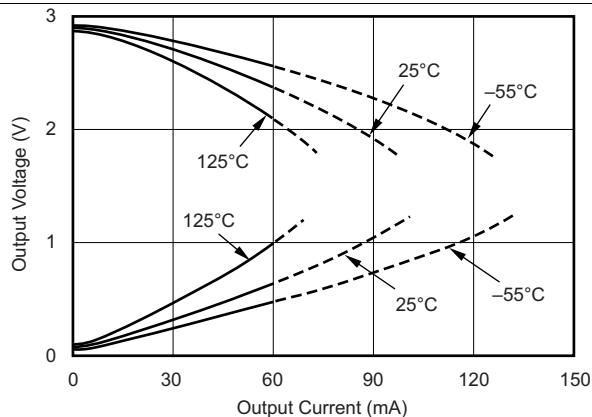

Figure 20. Input Bias Current vs Temperature



Continuous currents above 60 mA are not recommended

Figure 21. Output Voltage Swing vs Output Current for  $V_S = 3\text{ V}$

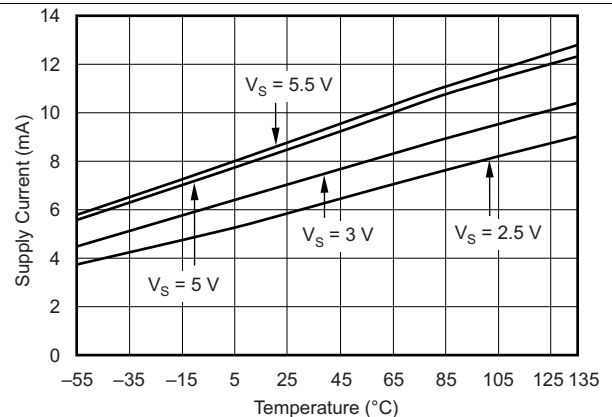
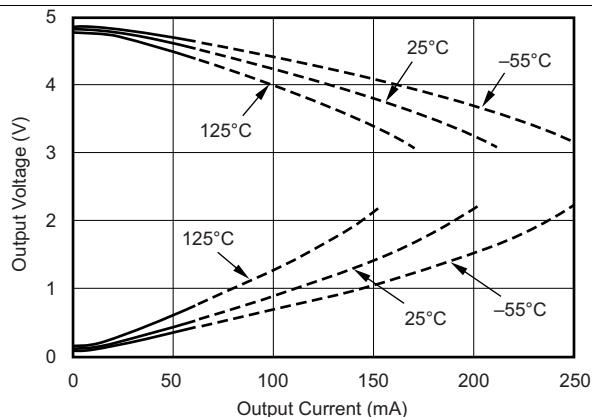

Figure 22. Supply Current vs Temperature



Continuous currents above 60 mA are not recommended

Figure 23. Output Voltage Swing vs Output Current for  $V_S = 5\text{ V}$

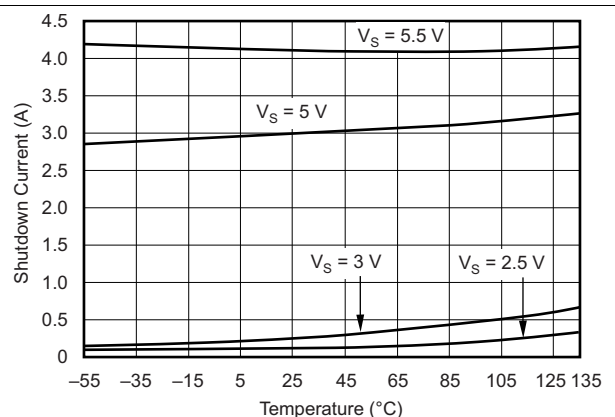

Figure 24. Shutdown Current vs Temperature

Typical Characteristics (continued)

At  $T_A = 25^\circ\text{C}$ ,  $V_S = 5\text{ V}$ ,  $G = 2$ ,  $R_F = 604\ \Omega$ , and  $R_L = 150\ \Omega$  connected to  $V_S / 2$ , unless otherwise noted.

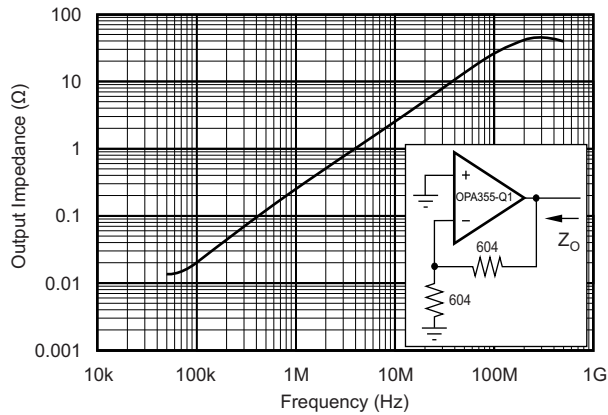
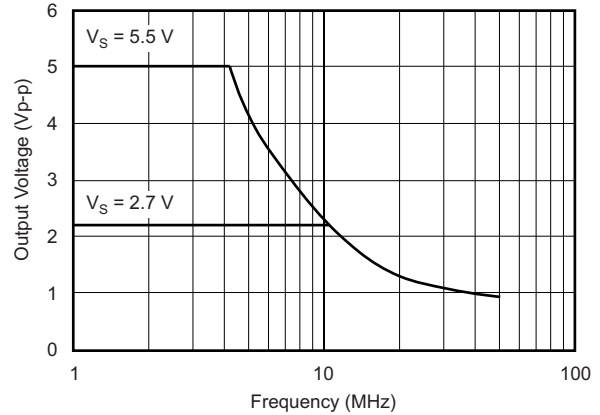

Figure 25. Closed-Loop Output Impedance vs Frequency



Maximum output voltage without slew-rate induced distortion

Figure 26. Maximum Output Voltage vs Frequency

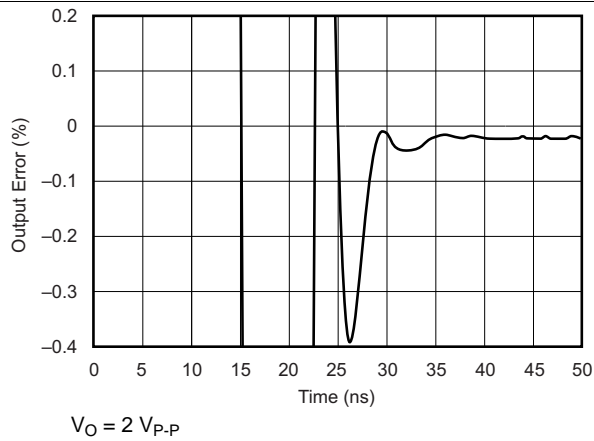

Figure 27. Output Settling Time to 0.1%

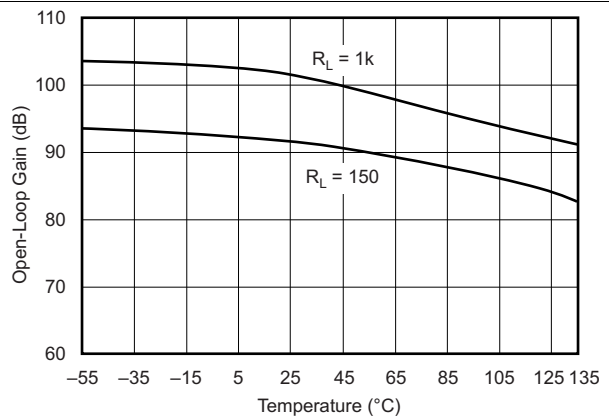

Figure 28. Open-Loop Gain vs Temperature

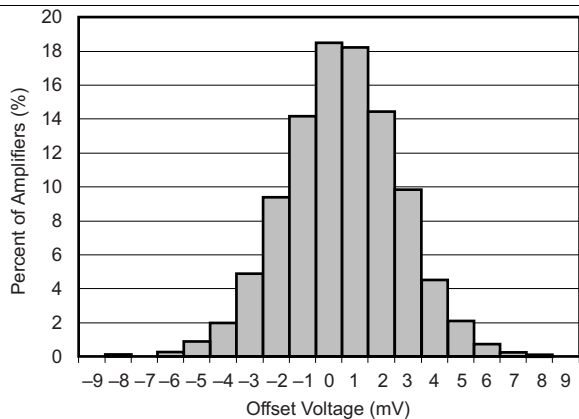

Figure 29. Offset Voltage Production Distribution

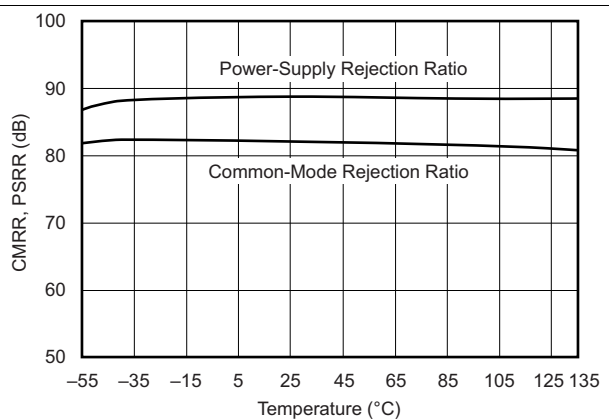

Figure 30. Common-Mode Rejection Ratio and Power-Supply Rejection Ratio vs Temperature

## 8 Detailed Description

### 8.1 Feature Description

#### 8.1.1 Operating Voltage

The OPA355-Q1 device is specified over a power-supply range of 2.7 to 5.5 V ( $\pm 1.35$  to  $\pm 2.75$  V). However, the supply voltage can range from 2.5 to 5.5 V ( $\pm 1.25$  to  $\pm 2.75$  V). Supply voltages higher than 7.5 V (absolute maximum) can permanently damage the amplifier.

Parameters that vary significantly over supply voltage or temperature are shown in the [Typical Characteristics](#) section of this data sheet.

#### 8.1.2 Enable Function

The OPA355-Q1 device is enabled by applying a TTL HIGH-voltage level to the Enable pin. Conversely, a TTL LOW-voltage level disables the amplifier which reduces the supply current from 8.3 mA to only 3.4  $\mu$ A per amplifier. This pin voltage is referenced to a single-supply ground. When using a split-supply, such as  $\pm 2.5$  V, the enable and disable voltage levels are referenced to  $V_{-}$ . Independent Enable pins are available for each channel, providing maximum design flexibility. For portable battery-operated applications, this feature can be used to greatly reduce the average current and thereby extend battery life.

The Enable input can be modeled as a CMOS input gate with a 100-k $\Omega$  pullup resistor to  $V_{+}$ . Left open, the Enable pin assumes a logic HIGH, and the amplifier turns on.

The Enable time is 100 ns and the disable time is 30 ns which allows the OPA355-Q1 device to operate as a *gated* amplifier, or to have the output multiplexed onto a common output bus. When disabled, the output assumes a high-impedance state.

#### 8.1.3 Output Drive

The output stage supplies a high short-circuit current (typically over 200 mA). Therefore, an on-chip thermal shutdown circuit is provided to protect the OPA355-Q1 device from dangerously-high junction temperatures. At 160°C, the protection circuit shuts down the amplifier. Normal operation resumes when the junction temperature cools to below 140°C.

#### NOTE

Running a continuous DC current in excess of  $\pm 60$  mA is not recommended. Refer to the *Output Voltage Swing vs Output Current* graphs ([Figure 21](#) and [Figure 22](#)) in the [Typical Characteristics](#) section.

#### 8.1.4 Input and ESD Protection

All OPA355-Q1 pins are static protected with internal ESD protection diodes tied to the supplies (see [Figure 31](#)).

If the current is externally limited to 10 mA by the source or by a resistor, these diodes provide overdrive protection.

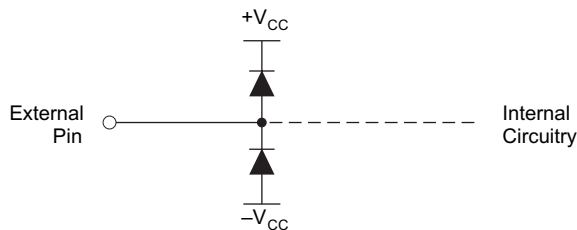

Figure 31. Internal ESD Protection

## 9 Application and Implementation

### 9.1 Application Information

The OPA355-Q1 device is a CMOS, high-speed, voltage-feedback, operational amplifier (op-amp) designed for general-purpose applications.

The amplifier features a 200-MHz gain bandwidth and 360-V/ $\mu$ s slew rate, but the device is unity-gain stable and can operate as a 1-V/V voltage follower.

The input common-mode voltage range of the device includes ground which allows the OPA355-Q1 to be used in virtually any single-supply application up to a supply voltage of +5.5 V.

## 10 Layout

### 10.1 Layout Guidelines

Good high-frequency printed-circuit board (PCB) layout techniques must be used for the OPA355-Q1. Generous use of ground planes, short direct-signal traces, and a suitable bypass capacitor located at the V+ pin will assure clean and stable operation. Large areas of copper also help dissipate heat generated within the amplifier in normal operation.

Sockets are not recommended for use with any high-speed amplifier.

A 10-nF ceramic bypass capacitor is the minimum recommended value; adding a 1- $\mu$ F or larger tantalum capacitor in parallel can be beneficial when driving a low-resistance load. Providing adequate bypass capacitance is essential to achieving very low harmonic and intermodulation distortion.

## 11 Device and Documentation Support

### 11.1 Trademarks

All trademarks are the property of their respective owners.

### 11.2 Electrostatic Discharge Caution



These devices have limited built-in ESD protection. The leads should be shorted together or the device placed in conductive foam during storage or handling to prevent electrostatic damage to the MOS gates.

### 11.3 Glossary

[SLYZ022](#) — *TI Glossary*.

This glossary lists and explains terms, acronyms, and definitions.

## 12 Mechanical, Packaging, and Orderable Information

The following pages include mechanical, packaging, and orderable information. This information is the most current data available for the designated devices. This data is subject to change without notice and revision of this document. For browser-based versions of this data sheet, refer to the left-hand navigation.

**PACKAGING INFORMATION**

| Orderable Device | Status<br>(1) | Package Type | Package<br>Drawing | Pins | Package<br>Qty | Eco Plan<br>(2)            | Lead/Ball Finish<br>(6) | MSL Peak Temp<br>(3) | Op Temp (°C) | Device Marking<br>(4/5) | Samples        |
|------------------|---------------|--------------|--------------------|------|----------------|----------------------------|-------------------------|----------------------|--------------|-------------------------|----------------|
| OPA355QDBVRQ1    | ACTIVE        | SOT-23       | DBV                | 6    | 3000           | Green (RoHS<br>& no Sb/Br) | CU NIPDAU               | Level-2-260C-1 YEAR  | -40 to 125   | SLN                     | <b>Samples</b> |

(1) The marketing status values are defined as follows:

**ACTIVE:** Product device recommended for new designs.

**LIFEBUY:** TI has announced that the device will be discontinued, and a lifetime-buy period is in effect.

**NRND:** Not recommended for new designs. Device is in production to support existing customers, but TI does not recommend using this part in a new design.

**PREVIEW:** Device has been announced but is not in production. Samples may or may not be available.

**OBSELETE:** TI has discontinued the production of the device.

(2) Eco Plan - The planned eco-friendly classification: Pb-Free (RoHS), Pb-Free (RoHS Exempt), or Green (RoHS & no Sb/Br) - please check <http://www.ti.com/productcontent> for the latest availability information and additional product content details.

**TBD:** The Pb-Free/Green conversion plan has not been defined.

**Pb-Free (RoHS):** TI's terms "Lead-Free" or "Pb-Free" mean semiconductor products that are compatible with the current RoHS requirements for all 6 substances, including the requirement that lead not exceed 0.1% by weight in homogeneous materials. Where designed to be soldered at high temperatures, TI Pb-Free products are suitable for use in specified lead-free processes.

**Pb-Free (RoHS Exempt):** This component has a RoHS exemption for either 1) lead-based flip-chip solder bumps used between the die and package, or 2) lead-based die adhesive used between the die and leadframe. The component is otherwise considered Pb-Free (RoHS compatible) as defined above.

**Green (RoHS & no Sb/Br):** TI defines "Green" to mean Pb-Free (RoHS compatible), and free of Bromine (Br) and Antimony (Sb) based flame retardants (Br or Sb do not exceed 0.1% by weight in homogeneous material)

(3) MSL, Peak Temp. - The Moisture Sensitivity Level rating according to the JEDEC industry standard classifications, and peak solder temperature.

(4) There may be additional marking, which relates to the logo, the lot trace code information, or the environmental category on the device.

(5) Multiple Device Markings will be inside parentheses. Only one Device Marking contained in parentheses and separated by a "~" will appear on a device. If a line is indented then it is a continuation of the previous line and the two combined represent the entire Device Marking for that device.

(6) Lead/Ball Finish - Orderable Devices may have multiple material finish options. Finish options are separated by a vertical ruled line. Lead/Ball Finish values may wrap to two lines if the finish value exceeds the maximum column width.

**Important Information and Disclaimer:** The information provided on this page represents TI's knowledge and belief as of the date that it is provided. TI bases its knowledge and belief on information provided by third parties, and makes no representation or warranty as to the accuracy of such information. Efforts are underway to better integrate information from third parties. TI has taken and continues to take reasonable steps to provide representative and accurate information but may not have conducted destructive testing or chemical analysis on incoming materials and chemicals. TI and TI suppliers consider certain information to be proprietary, and thus CAS numbers and other limited information may not be available for release.

In no event shall TI's liability arising out of such information exceed the total purchase price of the TI part(s) at issue in this document sold by TI to Customer on an annual basis.

**OTHER QUALIFIED VERSIONS OF OPA355-Q1 :**

- Catalog: [OPA355](#)

## NOTE: Qualified Version Definitions:

- Catalog - TI's standard catalog product

# MECHANICAL DATA

DBV (R-PDSO-G6)

PLASTIC SMALL-OUTLINE PACKAGE



- NOTES:
- All linear dimensions are in millimeters.
  - This drawing is subject to change without notice.
  - Body dimensions do not include mold flash or protrusion. Mold flash and protrusion shall not exceed 0.15 per side.
  - Leads 1,2,3 may be wider than leads 4,5,6 for package orientation.
- Falls within JEDEC MO-178 Variation AB, except minimum lead width.



DBV (R-PDSO-G6)

PLASTIC SMALL OUTLINE



- NOTES:
- A. All linear dimensions are in millimeters.
  - B. This drawing is subject to change without notice.
  - C. Customers should place a note on the circuit board fabrication drawing not to alter the center solder mask defined pad.
  - D. Publication IPC-7351 is recommended for alternate designs.
  - E. Laser cutting apertures with trapezoidal walls and also rounding corners will offer better paste release. Customers should contact their board assembly site for stencil design recommendations. Example stencil design based on a 50% volumetric metal load solder paste. Refer to IPC-7525 for other stencil recommendations.

## IMPORTANT NOTICE

Texas Instruments Incorporated and its subsidiaries (TI) reserve the right to make corrections, enhancements, improvements and other changes to its semiconductor products and services per JESD46, latest issue, and to discontinue any product or service per JESD48, latest issue. Buyers should obtain the latest relevant information before placing orders and should verify that such information is current and complete. All semiconductor products (also referred to herein as "components") are sold subject to TI's terms and conditions of sale supplied at the time of order acknowledgment.

TI warrants performance of its components to the specifications applicable at the time of sale, in accordance with the warranty in TI's terms and conditions of sale of semiconductor products. Testing and other quality control techniques are used to the extent TI deems necessary to support this warranty. Except where mandated by applicable law, testing of all parameters of each component is not necessarily performed.

TI assumes no liability for applications assistance or the design of Buyers' products. Buyers are responsible for their products and applications using TI components. To minimize the risks associated with Buyers' products and applications, Buyers should provide adequate design and operating safeguards.

TI does not warrant or represent that any license, either express or implied, is granted under any patent right, copyright, mask work right, or other intellectual property right relating to any combination, machine, or process in which TI components or services are used. Information published by TI regarding third-party products or services does not constitute a license to use such products or services or a warranty or endorsement thereof. Use of such information may require a license from a third party under the patents or other intellectual property of the third party, or a license from TI under the patents or other intellectual property of TI.

Reproduction of significant portions of TI information in TI data books or data sheets is permissible only if reproduction is without alteration and is accompanied by all associated warranties, conditions, limitations, and notices. TI is not responsible or liable for such altered documentation. Information of third parties may be subject to additional restrictions.

Resale of TI components or services with statements different from or beyond the parameters stated by TI for that component or service voids all express and any implied warranties for the associated TI component or service and is an unfair and deceptive business practice. TI is not responsible or liable for any such statements.

Buyer acknowledges and agrees that it is solely responsible for compliance with all legal, regulatory and safety-related requirements concerning its products, and any use of TI components in its applications, notwithstanding any applications-related information or support that may be provided by TI. Buyer represents and agrees that it has all the necessary expertise to create and implement safeguards which anticipate dangerous consequences of failures, monitor failures and their consequences, lessen the likelihood of failures that might cause harm and take appropriate remedial actions. Buyer will fully indemnify TI and its representatives against any damages arising out of the use of any TI components in safety-critical applications.

In some cases, TI components may be promoted specifically to facilitate safety-related applications. With such components, TI's goal is to help enable customers to design and create their own end-product solutions that meet applicable functional safety standards and requirements. Nonetheless, such components are subject to these terms.

No TI components are authorized for use in FDA Class III (or similar life-critical medical equipment) unless authorized officers of the parties have executed a special agreement specifically governing such use.

Only those TI components which TI has specifically designated as military grade or "enhanced plastic" are designed and intended for use in military/aerospace applications or environments. Buyer acknowledges and agrees that any military or aerospace use of TI components which have **not** been so designated is solely at the Buyer's risk, and that Buyer is solely responsible for compliance with all legal and regulatory requirements in connection with such use.

TI has specifically designated certain components as meeting ISO/TS16949 requirements, mainly for automotive use. In any case of use of non-designated products, TI will not be responsible for any failure to meet ISO/TS16949.

### Products

|                              |  |
|------------------------------|--|
| Audio                        | <a href="http://www.ti.com/audio">www.ti.com/audio</a>                               |
| Amplifiers                   | <a href="http://amplifier.ti.com">amplifier.ti.com</a>                               |
| Data Converters              | <a href="http://dataconverter.ti.com">dataconverter.ti.com</a>                       |
| DLP® Products                | <a href="http://www.dlp.com">www.dlp.com</a>   |
| DSP                          | <a href="http://dsp.ti.com">dsp.ti.com</a>   |
| Clocks and Timers            | <a href="http://www.ti.com/clocks">www.ti.com/clocks</a>                             |
| Interface                    | <a href="http://interface.ti.com">interface.ti.com</a>                               |
| Logic                        | <a href="http://logic.ti.com">logic.ti.com</a>                                       |
| Power Mgmt                   | <a href="http://power.ti.com">power.ti.com</a>                                       |
| Microcontrollers             | <a href="http://microcontroller.ti.com">microcontroller.ti.com</a>                   |
| RFID                         | <a href="http://www.ti-rfid.com">www.ti-rfid.com</a>                                 |
| OMAP Applications Processors | <a href="http://www.ti.com/omap">www.ti.com/omap</a>                                 |
| Wireless Connectivity        | <a href="http://www.ti.com/wirelessconnectivity">www.ti.com/wirelessconnectivity</a> |

### Applications

|                               |  |
|-------------------------------|--|
| Automotive and Transportation | <a href="http://www.ti.com/automotive">www.ti.com/automotive</a>                         |
| Communications and Telecom    | <a href="http://www.ti.com/communications">www.ti.com/communications</a>                 |
| Computers and Peripherals     | <a href="http://www.ti.com/computers">www.ti.com/computers</a>                           |
| Consumer Electronics          | <a href="http://www.ti.com/consumer-apps">www.ti.com/consumer-apps</a>                   |
| Energy and Lighting           | <a href="http://www.ti.com/energy">www.ti.com/energy</a>                                 |
| Industrial                    | <a href="http://www.ti.com/industrial">www.ti.com/industrial</a>                         |
| Medical                       | <a href="http://www.ti.com/medical">www.ti.com/medical</a>                               |
| Security                      | <a href="http://www.ti.com/security">www.ti.com/security</a>                             |
| Space, Avionics and Defense   | <a href="http://www.ti.com/space-avionics-defense">www.ti.com/space-avionics-defense</a> |
| Video and Imaging             | <a href="http://www.ti.com/video">www.ti.com/video</a>                                   |

### TI E2E Community

[e2e.ti.com](http://e2e.ti.com)