

FRED

Ultrafast Soft Recovery Diode Module

600A / 600V (300Ax2 / 600V)

FEATURES

- Very low Q_{rr} and t_{rr}
- Lead (Pb)-free
- Designed and qualified for industrial level
- Reduced RFI and EMI
- Industrial standard package
- Planar FRED Chips

DESCRIPTION

FRED diodes are optimized to reduce losses and EMI/RFI in high frequency power conditioning systems. An extensive characterization of the recovery behavior for different values of current, temperature and di/dt simplifies the calculations of losses in the operating conditions. The softness of the recovery eliminates the need for a snubber in most applications.

TYPICAL APPLICATIONS

- Power converters
- Motor drives
- Welders
- Switching power supplies
- Uninterruptible power supply (UPS)
- Power factor correction (PFC) circuit
- Inverter
- Choppers
- Battery chargers

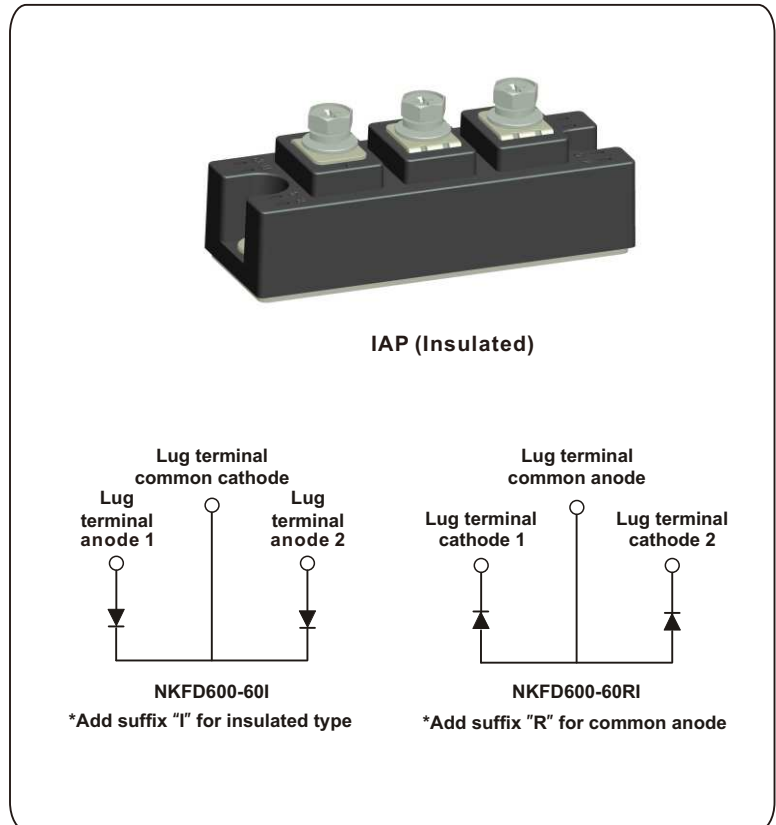

PRODUCT SUMMARY	
$I_{F(AV)}$	600A
V_R	600V
$I_{F(DC)}$ at T_C	360A at 100 °C

ABSOLUTE MAXIMUM RATINGS					
PARAMETER	SYMBOL	TEST CONDITIONS	MAX.	UNIT	
Cathode to anode voltage	V_R		600	V	
Average forward current	$I_{F(AV)}$	$T_C = 25^\circ\text{C}$, per leg	690	A	
		$T_C = 110^\circ\text{C}$	per device		600
			per leg		300
DC forward current	$I_{F(DC)}$	$T_C = 100^\circ\text{C}$	360		
Single pulse forward current	I_{FSM}	Limited by junction temperature, per leg	2700		
Non-repetitive avalanche energy	E_{AS}	$L = 100 \mu\text{H}$, duty cycle limited by maximum T_J	2.2	mJ	
Maximum power dissipation per leg	P_D	$T_C = 25^\circ\text{C}$	1220	W	
Operating junction and storage temperature range	T_J, T_{Stg}		- 55 to 150	$^\circ\text{C}$	

ELECTRICAL SPECIFICATIONS (T _J = 25 °C unless otherwise specified)						
PARAMETER	SYMBOL	TEST CONDITIONS	MIN.	TYP.	MAX.	UNIT
Cathode to anode breakdown voltage	V _{BR}	I _R = 100 μA	600	-	-	V
Maximum forward voltage	V _{FM}	I _F = 300 A	-	1.25	1.50	
		I _F = 600 A	-	-	1.70	
		I _F = 300 A, T _J = 125 °C	-	-	1.30	
Maximum reverse leakage current per leg	I _{RM}	T _J = 125 °C, V _R = 600V	-	0.4	4	mA
		T _J = 25 °C, V _R = 600V	-	1.0	10.0	μA
Junction capacitance	C _T	V _R = 200V	-	500	700	pF
Series inductance	L _S	From top of terminal hole to mounting plane	-	4.4	-	nH
Maximum RMS insulation voltage	V _{INS}	50Hz	-	-	2500(1min)	V
					3000(1s)	

DYNAMIC RECOVERY CHARACTERISTICS PER LEG (T _J = 25 °C unless otherwise specified)						
PARAMETER	SYMBOL	TEST CONDITIONS	MIN.	TYP.	MAX.	UNIT
Reverse recovery time	t _{rr}	I _F = 0.5A, I _R = 1.0A, I _{RR} = 0.25A	-	155	180	ns
		I _F = 1.0A, dI _F /dt = 200A/μs, V _R = 30V	-	60	-	
		T _J = 25 °C	-	120	-	
		T _J = 125 °C	-	350	-	
Peak recovery current	I _{RRM}	T _J = 25 °C	-	16.5	-	A
		T _J = 125 °C	-	23	-	
Reverse recovery charge	Q _{rr}	T _J = 25 °C	-	-	2800	nC
		T _J = 125 °C	-	-	5800	

THERMAL AND MECHANICAL SPECIFICATIONS					
PARAMETER	SYMBOL	MIN.	TYP.	MAX.	UNIT
Maximum junction and storage temperature range	T _J , T _{stg}	-55	-	150	°C
Thermal resistance, junction to case per leg	R _{thJC}	-	-	0.14	°C/W
Thermal resistance, junction to case per module	R _{thJC}	-	-	0.07	
Typical thermal resistance, case to heatsink	R _{thCS}	-	0.08	-	
Weight		-	155 (5.47)	-	g (oz.)
Mounting torque ⁽¹⁾ , M6		-	44.2 (5)	53.1 (6)	(N · m) lbf · in
Terminal torque, M6		-	44.2 (5)	53.1 (6)	
Vertical pull		-	-	80	lbf · in
2" lever pull		-	-	35	

Note

(1) Mounting surface must be smooth, flat, free of burrs or other protrusions. Apply a thin even film of thermal grease to mounting surface. Gradually tighten each mounting bolt in 5 to 10 lbf. in steps until desired or maximum torque limits are reached.

Ordering Information Table

Device code	NK	F	D	600	-	60	R	I
	①	②	③	④		⑤	⑥	⑦

- ① - Nell's power module
- ② - F for Ultrafast soft recovery diode (FRED)
- ③ - D for Dual Diodes, IAP Package
- ④ - Maximum average forward current, A
- ⑤ - Voltage rating (60 = 600V)
- ⑥ - None for common cathode configuration
"R" for common anode configuration
- ⑦ - "I" for insulated type

Fig.1 Typical forward voltage drop vs. Instantaneous forward current (per leg)

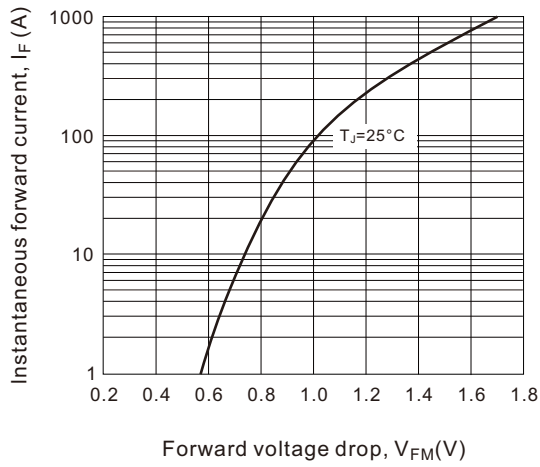

Fig.2 Typical reverse current vs. reverse voltage (per leg)

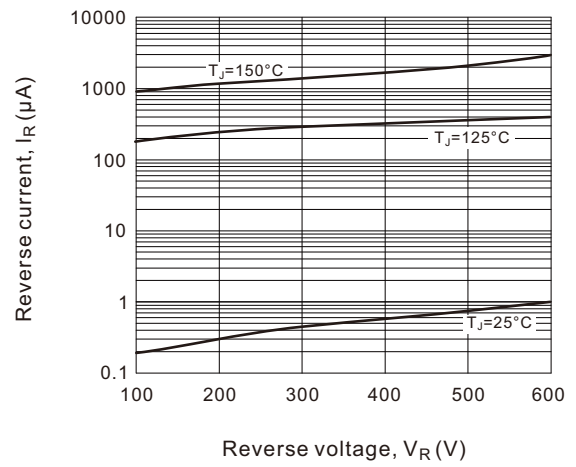

Fig.3 Typical junction capacitance vs. reverse voltage (per leg)

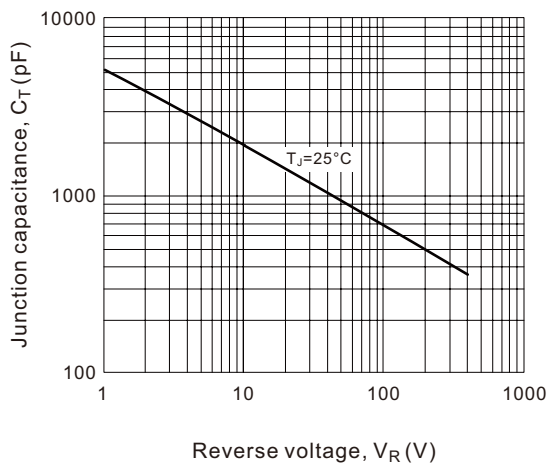

Fig.4 Maximum allowable case temperature vs. DC forward current (per leg)

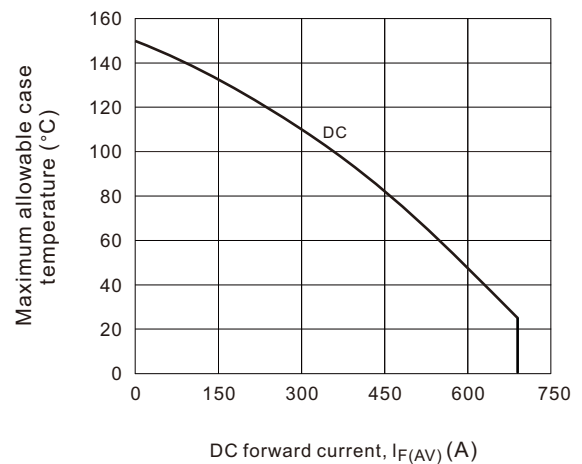

Fig.5 Typical reverse recovery time vs. di_F/dt (per leg)

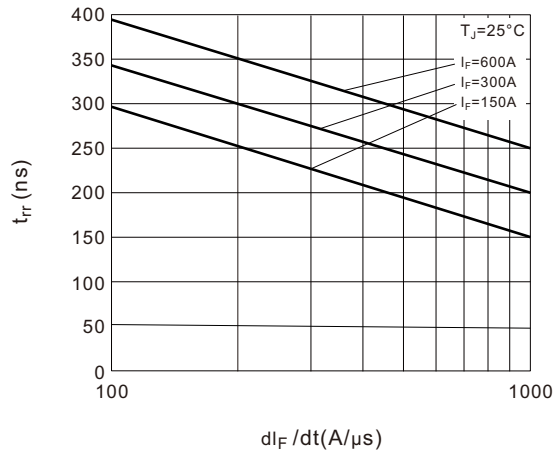

Fig.6 Maximum thermal impedance $R_{th(j-c)}$ characteristics (Per leg)

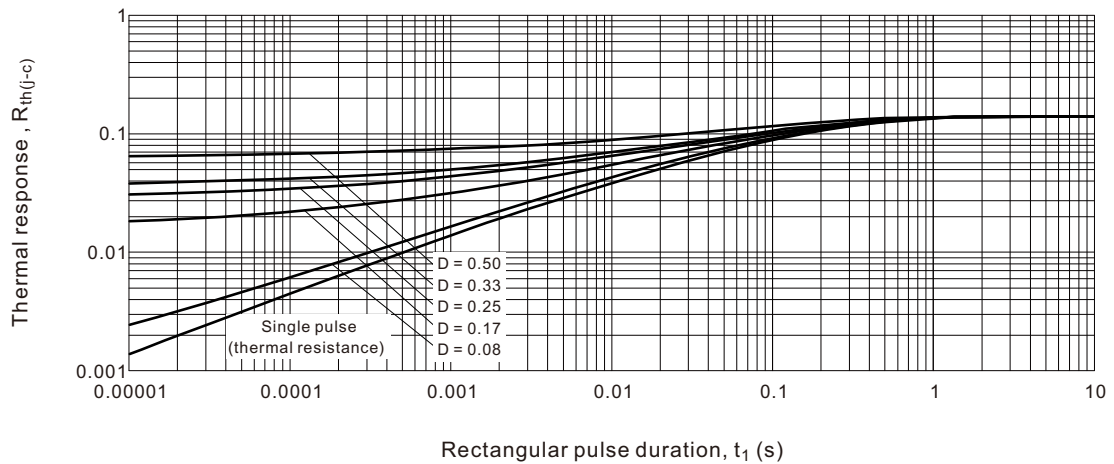

Fig.7 Reverse recovery parameter test circuit

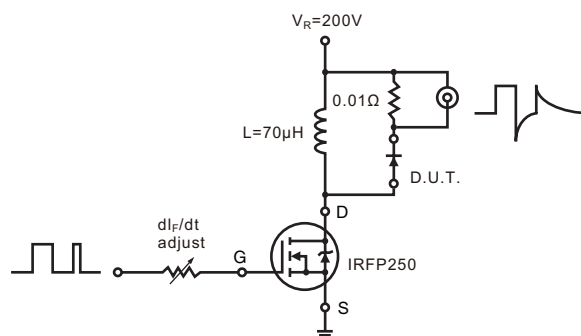
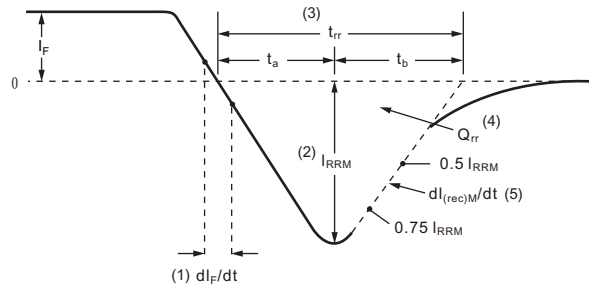

Fig.08 Reverse recovery waveform and definitions



- (1) di_F/dt - rate of change of current through zero crossing
- (2) I_{RRM} - peak reverse recovery current
- (3) t_{rr} - reverse recovery time measured from zero crossing point of negative going I_F to point where a line passing through $0.75 I_{RRM}$ and $0.50 I_{RRM}$ extrapolated to zero current.
- (4) Q_{rr} - area under curve defined by t_{rr} and I_{RRM}
- (5) $di_{(rec)M}/dt$ - peak rate of change of current during t_b portion of t_{rr}

$$Q_{rr} = \frac{t_{rr} \times I_{RRM}}{2}$$

Fig.09 Avalanche test circuit and waveforms

