

# FL SWITCH SFNB...

## Five- and Eight-Port Standard Function Ethernet Switch with Narrow Housing

### AUTOMATION

Data Sheet  
2642\_en\_H

© PHOENIX CONTACT 2011-07-10



## 1 Description

The FL SWITCH SFNB... Factoryline switches can be used for quick and cost-effective Ethernet network expansion to the field level. Due to the narrow housing design, the switches are suitable for use in control cabinets and junction boxes. The switch supports the auto negotiation function and offers transmission speeds of 10/100 Mbps across RJ45 ports and 100 Mbps across fiber optic ports. Mixed operation for the connection of segments with different data transmission speeds is also supported.

The RJ45 ports offer an autocrossing function, which means it is not necessary to make a distinction between 1:1 and crossover cables.

Switches are available with either SC or ST multi-mode fiber optic ports. For longer distance, a single-mode fiber optic switch extends the segment to 20 km typical.

## 2 Features and Benefits

- Increased network performance
  - Switched Ethernet networks reduce traffic and non-predictable timing
- Easy network expansion
  - No configuration of the switch
  - Auto-negotiation and autocross simplify cabling
  - Couple copper network segments with different bit rates with automatic detection of the data transmission speed of 10 or 100 Mbps.
- Easy maintenance
  - Individual LEDs at each port indicate communication activity and data rate
  - Removable power connector
  - Internal, resettable fuse
  - NS 35 DIN rail (EN 60715) compatible
- Fiber optic ports extend distance and provide electrical noise immunity
  - SC multi-mode, SC single-mode and ST multi-mode versions available
- Industrial rated
  - Rugged metal housing for industrial applications
  - -10 to 60°C operating range
  - Meets IEC 61000-6-2 electrical noise immunity
  - Meets IEC 60068-2-6 vibration test standards
  - Meets IEC 60068-2-27 shock test standards



Make sure you always use the latest documentation.  
It can be downloaded at [www.phoenixcontact.net/catalog](http://www.phoenixcontact.net/catalog).



This data sheet is valid for all products listed on the following page:

### 3 Ordering Data

Description	Type	Order No.	Pcs./Pkt.
Ethernet switch with 5 RJ45 ports	FL SWITCH SFNB 5TX	2891001	1
Ethernet switch with 8 RJ45 ports	FL SWITCH SFNB 8TX	2891002	1
Ethernet switch with 4 RJ45 ports and 1 SC format fiber optic port	FL SWITCH SFNB 4TX/FX	2891027	1
Ethernet switch with 4 RJ45 ports and 1 ST format fiber optic port	FL SWITCH SFNB 4TX/FX ST	2891028	1
Ethernet switch with 4 RJ45 ports and 1 SC format single-mode fiber optic port	FL SWITCH SFNB 4TX/FX SM20	2891029	1

#### Accessories

Description	Type	Order No.	Pcs./Pkt.
Universal end clamp	E/NS 35 N	0800886	50
Patch angle with 2 ports in CAT 5e	FL PF 2TX CAT5E	2891165	1
Patch angle with 8 ports in CAT 5e	FL PF 8TX CAT5E	2891178	1
Patch angle with 2 ports in CAT 6	FL PF 2TX CAT6	2891068	1
Patch angle with 8 ports in CAT 6	FL PF 8TX CAT6	2891071	1
Patch angle with security elements for 2 ports in CAT 5e	FL PF SEC 2TX	2832687	1
Patch angle with security elements for 8 ports in CAT 5e	FL PF SEC 8TX	2832690	1
Patchbox 8 x RJ45 CAT 5e, pre-assembled, can be retrofitted	FL PBX 8TX	2832496	1
Patch cable, CAT 5, pre-assembled, 0.3 m long	FL CAT5 PATCH 0,3	2832250	10
Patch cable, CAT 5, pre-assembled, 0.5 m long	FL CAT5 PATCH 0,5	2832263	10
Patch cable, CAT 5, pre-assembled, 1.0 m long	FL CAT5 PATCH 1,0	2832276	10
Patch cable, CAT 5, pre-assembled, 1.5 m long	FL CAT5 PATCH 1,5	2832221	10
Patch cable, CAT 5, pre-assembled, 2.0 m long	FL CAT5 PATCH 2,0	2832289	10
Patch cable, CAT 5, pre-assembled, 3.0 m long	FL CAT5 PATCH 3,0	2832292	10
Patch cable, CAT 5, pre-assembled, 5.0 m long	FL CAT5 PATCH 5,0	2832580	10
Patch cable, CAT 5, pre-assembled, 7.5 m long	FL CAT5 PATCH 7,5	2832616	10
Patch cable, CAT 5, pre-assembled, 10.0 m long	FL CAT5 PATCH 10	2832629	10
Lockable security element for FL PATCH...	FL PATCH GUARD	2891424	20
Key for FL PATCH GUARD	FL PATCH GUARD KEY	2891521	1
Color marker for FL PATCH GUARD, black	FL PATCH GUARD CCODE BK	2891136	12
Color marker for FL PATCH GUARD, blue	FL PATCH GUARD CCODE BU	2891233	12
Color marker for FL PATCH GUARD, orange	FL PATCH GUARD CCODE OG	2891330	12
Color marker for FL PATCH GUARD, yellow	FL PATCH GUARD CCODE YE	2891437	12
Color marker for FL PATCH GUARD, turquoise	FL PATCH GUARD CCODE TQ	2891534	12
Color marker for FL PATCH GUARD, green	FL PATCH GUARD CCODE GN	2891631	12
Color marker for FL PATCH GUARD, red	FL PATCH GUARD CCODE RD	2891738	12
Color marker for FL PATCH GUARD, violet	FL PATCH GUARD CCODE VT	2891835	12

## 4 Technical Data

General Data	
Function	Switch/repeater; conforms to standard IEEE 802.3
Latency of the communication processor	
FL SWITCH SFNB 5(4)TX...	8 $\mu$ s plus frame time
FL SWITCH SFNB 8TX	9 $\mu$ s plus frame time
Housing dimensions (width x height x depth)	
FL SWITCH SFNB 5(4)TX...	28 x 110 x 70 mm
FL SWITCH SFNB 8TX	50 x 110 x 70 mm
Weight	
FL SWITCH SFNB 5(4)TX...	205 g
FL SWITCH SFNB 8TX	291 g
Operating temperature	
All models except FL SWITCH SFNB 4TX/FX	-10°C ... 60°C
FL SWITCH SFNB 4TX/FX	0°C ... 60°C
Storage temperature	-20°C ... 85°C
Degree of protection	IP20, DIN 40050, IEC 60529
Protection class	Class 3 VDE 0106; IEC 60536
Humidity (operation and storage)	5% to 95%, no condensation
Air pressure (operation)	86 kPa to 108 kPa, 1500 m above sea level
Air pressure (storage)	66 kPa to 108 kPa, 3500 m above sea level
Mounting rail	NS 35 (EN 60715)
Preferred mounting position	Perpendicular to a standard mounting rail
Connection to protective earth ground	Snapped onto a grounded mounting rail
Supply Voltage (US)	
Connection type	Removable, screw-clamp connector
Wire size (solid/stranded/AWG)	0.2 to 2.5 mm <sup>2</sup> / 0.2 to 2.5 mm <sup>2</sup> / 24 to 12 AWG
Recommended PE wire size	2.5 mm <sup>2</sup>
Nominal power supply	24 V DC
Permissible ripple	3.6 V <sub>pp</sub> within the permissible voltage range
Permissible voltage range	
FL SWITCH SFNB 5(4)TX...	12 V DC ... 48 V DC
FL SWITCH SFNB 8TX	9 V DC ... 32 V DC
Current consumption, nominal	
FL SWITCH SFNB 5TX	180 mA@24 V DC; 340 mA@12 V DC
FL SWITCH SFNB 8TX	138 mA@24 V DC; 272 mA@12 V DC
FL SWITCH SFNB 4TX/FX	185 mA@24 V DC; 385 mA@12 V DC
FL SWITCH SFNB 4TX/FX ST	185 mA@24 V DC; 385 mA@12 V DC
FL SWITCH SFNB 4TX/FS SM20	185 mA@24 V DC; 385 mA@12 V DC
Inrush current maximum	
FL SWITCH SFNB 5TX	15 A for 35 $\mu$ s
FL SWITCH SFNB 8TX	9.1 A for 40 $\mu$ s
FL SWITCH SFNB 4TX/FX	7.2 A for 80 $\mu$ s
FL SWITCH SFNB 4TX/FX ST	7.7 A for 80 $\mu$ s
FL SWITCH SFNB 4TX/FX SM20	7.7 A for 80 $\mu$ s
Test voltage	500 V DC for one minute
Protection against polarity reversal	Present
Interfaces	
Total number of Ethernet interfaces (RJ45)	
FL SWITCH SFNB 5TX	5
FL SWITCH SFNB 8TX	8
FL SWITCH SFNB 4TX...	4
MAC Address Table Size (Entries)	2 K
Properties of RJ45 Ports	
Connection format	8-pos. RJ45 female connector on the switch

**Interfaces (Continued)**

Connection medium	Twisted-pair cable with a conductor cross section of 0.14 mm <sup>2</sup> to 0.22 mm <sup>2</sup>
Cable impedance	100 Ω
Transmission speed	10/100 Mbps
Maximum network segment length	100 m

**Properties of Fiber Optic Ports**

Connection format	SC duplex or ST female connector
Fiber type	Glass
Laser protection	Class 1 according to DIN EN 60825-1:2001-11

**Properties of 100 Mbps Multimode**

Transmission rate	100 Mbps full duplex
Wavelength	1300/1310 nm
Fiber optic segment length	12.1 km with glass fiber 62.5/125 0.7 dB/km F1000 3.3 km with glass fiber 62.5/125 2.6 dB/km F600 7.1 km glass fiber with F-G 50/125 0.7 dB/km F1200 3.1 km glass fiber with F-G 50/125 1.6 dB/km F800

## Transmission power (medium type) dynamic (average)

Minimum	-23.5 dBm (50/125 μm) / -20 dBm (62.5/125 μm)
Maximum	-14 dBm (50/125 μm) / -14 dBm (62.5/125 μm)

## Transmission power (medium type) static

Minimum	-22.5 dBm (50/125 μm) / -19 dBm (62.5/125 μm)
Maximum	-14 dBm (50/125 μm) / -14 dBm (62.5/125 μm)

## Receiver sensitivity

Minimum	-31 dBm (dynamic) / -31 dBm (static)
Maximum	-14 dBm (dynamic) / -14 dBm (static)

**Properties of 100 Mbps single mode**

Transmission rate	100 Mbps full duplex
Fiber type	9/125 μm
Wavelength	1310 nm
Maximum transmission length	25 km with glass fiber 9/125 μm 0.5 dB/km
Transmission power	
Minimum	-15 dBm
Maximum	-3 dBm
Receiver sensitivity	
Minimum	-32 dBm
Maximum	-3 dBm

**Mechanical Tests**

Shock test according to IEC 60068-2-27	Operation: 25g, 11 ms period, half-sine shock pulse Storage/transport: 50g, 11 ms period, half-sine shock pulse
Vibration resistance according to IEC 60068-2-6	Operation/storage/transport: 5g, 150 Hz, Criterion 3
Free fall according to IEC 60068-2-32	1 m



**Conformance With EMC Directives**

## Developed according to IEC 61000-6-2

IEC 61000-4-2 (ESD)	Contact: ±4 kV, Criterion B Air: ±8 kV, Criterion B
IEC 61000-4-3 (radiated-noise immunity)	10 V/m, Criterion A
IEC 61000-4-4 (burst)	Ports: ±1 kV, Criterion B DC power: ±2 kV, Criterion B
IEC 61000-4-5 (surge)	Ports: ±1 kV, Criterion B DC power: ±500 V, Criterion B
IEC 61000-4-6 (conducted noise immunity)	10 V/m, Criterion A
IEC 61000-4-8 (noise immunity against magnetic fields)	30 A/m, Criterion A
EN 55022 (noise emission)	Class A

**Approvals**

General

CE   ROHS EEE 2002/95/EC, WEEE 2002/96/EC

Hazardous location

 Class 1, Division 2, Groups A, B, C, D Temp Code T5 installed in minimum IP54 enclosure

**5 Overview**

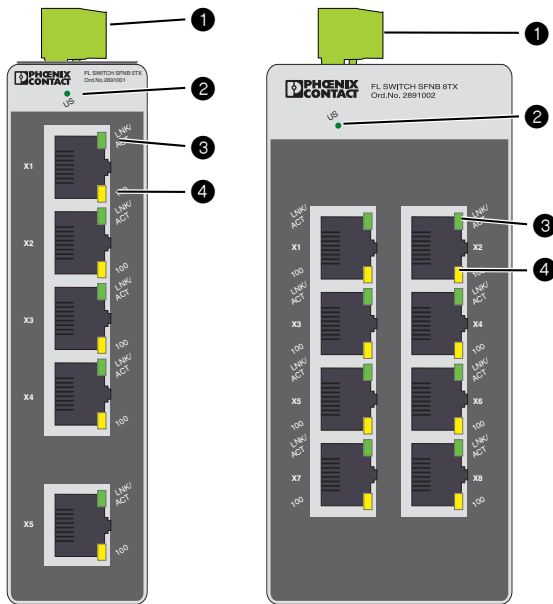

- 1 Power connector
- 2 Power LED (US) - green
- 3 LNK/ACT LED - green
- 4 100 LED - yellow

Figure 1 Housing

**5.1 Diagnostic and Status Indicators**

Des.	Color	Status	Meaning
US	Green	ON	Supply voltage US in the tolerance range
		OFF	Supply voltage US too low

**5.2 Data Transmission Speed LEDs (2 LEDs/Port)**

	10 Mbps	100 Mbps
<b>LNK/ACT</b>	ON/blinking	ON/blinking
<b>100</b>	OFF	ON



**LNK/ACT LED:**  
 ON: indicates an electrical link  
 Flashing: indicates network traffic (at high data rates the blinking is in a constant rate)

## 6 Installation



**CAUTION:**

Only qualified personnel may start up and operate this device. Qualified personnel are persons authorized to start up, ground and mark devices, systems, and equipment according to the standards of safety technology.



**NOTE:**

The FL SWITCH SFNB... module is designed for SELV and PELV operation according to IEC 61140/EN 61140.

Install the FL SWITCH SFNB... on a clean mounting rail. To avoid contact resistance only use clean, corrosion-free mounting rails that meet the EN 60715 standard. End clamps can be mounted on both sides of the module to stop the modules from slipping on the rail.



**NOTE:**

Connect the mounting rail to protective earth ground using a grounding terminal block. The modules are grounded when they are snapped onto the rail. Connect protective earth ground with low impedance.

### 6.1 Assembly

1. Place the module onto the rail from above. The upper holding keyway must be hooked onto the top edge of the rail.
2. Push the module from the front towards the mounting surface.
3. Once the module has been snapped on properly, check that it is fixed securely on the rail.

### 6.2 Removal

1. Insert a suitable tool (e.g., needle-nose pliers) into the arresting latch and pull it down.
2. Pull the module slightly away from the mounting surface.
3. Lift the module from the rail.

### 6.3 Power Connection

The switch is designed for SELV and PELV operation at +24 V DC according to IEC 61140/EN 61140. Only SELV and PELV according to the defined standards may be used for supply purposes.

Snapping the switch onto a grounded mounting rail connects it to the ground potential. In an environment particularly prone to EMI, noise immunity can be increased

by an additional low-impedance connection to functional earth ground (see Figure 2).

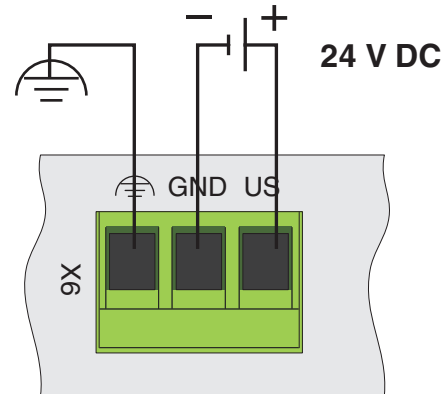

Figure 2 Power connections

Use power conductors between 0.2 - 2.5 mm<sup>2</sup> (24 - 12 AWG). Torque connection screws to 0.5 - 0.6 Nm (5 - 7 lb-in.).

### 6.4 Ethernet Interface

The FL SWITCH SFNB... has either five or eight Ethernet ports on the front in RJ45 format to which only twisted-pair cables with an impedance of 100 Ω can be connected. The data transmission speed is 10/100 Mbps. In addition, every port has an auto crossing function: it is not necessary to make a distinction between 1:1 or crossover Ethernet cables.

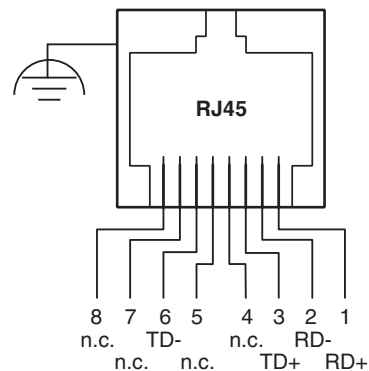

Figure 3 RJ45 pin assignment

### 6.5 Fiber Optic Connection

Two different types of fiber optic connection are available.

- The ST connectors are typically individual round connectors and use a 1/4-turn connection.
- The SC connectors have a square interface and the “conductors” are typically locked together through the connector.

#### SC Connectors

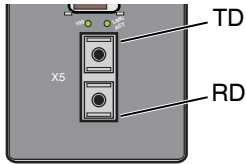

#### ST Connectors

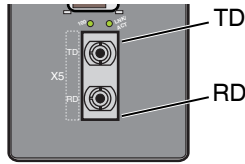

Figure 4 Fiber optic ports

## 7 Switching Characteristics

### - Store and Forward

All data telegrams received by the switch are saved and their validity checked. Invalid or faulty data packets (> 1522 bytes or CRC errors) and fragments (< 64 bytes) are rejected. Valid data telegrams are forwarded by the switch. The switch always forwards the data using the data transmission speed that is used in the destination network segment.

### - Multi-Address Function

The switch independently learns the addresses for termination devices, which are connected via a port, by evaluating the source addresses in the data telegrams. Only packets with unknown addresses, with a source address of this port or with a multicast/broadcast address in the destination address field are forwarded via the corresponding port. The switch can store addresses in its address table with an aging time of 5 minutes. This is important when more than one termination device is connected to one or more ports. In this way, several independent subnetworks can be connected to one switch.



A restart deletes the entire address table.

## 8 Dimensions

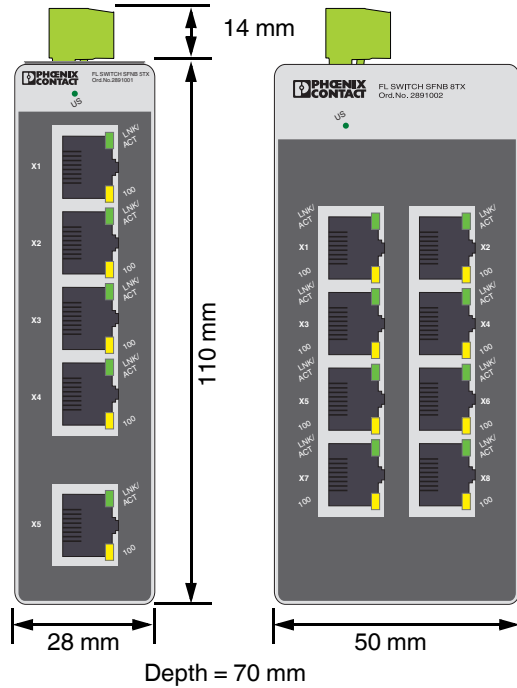

Figure 5 Housing dimensions