

## DETAILS

<b>Product Number</b>	CA13057_FLARE-MINI-AD
<b>Family</b>	Flare
<b>Type</b>	Assembly
<b>Color</b>	clear
<b>Diameter</b>	16 mm
<b>Height</b>	9,1 mm
<b>Style</b>	round
<b>Optic Material</b>	PMMA
<b>Holder Material</b>	
<b>Fastening</b>	tape
<b>Status</b>	production ready
<b>ROHS Compliant</b>	Yes
<b>Date Updated</b>	5/10/2015



## OPTICAL PROPERTIES

LED	Viewing	Light	Effi-		Connector
	Angle	Beam	ciency	cd/lm	
XB-D	100+16 deg	Oval	93 %	1.200	-
XP-G	100+20 deg	Oval	94 %	1.100	-
XT-E	104+19 deg	Oval	94 %	1.100	-
XP-E2	90+16 deg	Oval	94 %	1.400	-
XP-G2	95+21 deg	Oval	94 %	1.100	-
XP-L	111+28 deg	Oval	94 %	0.820	-
XHP35 HD	sim: 97+29	Oval	sim: 92 %	sim: 0.850	-
XHP35 HI	sim: 96+21	Oval	sim: 94 %	sim: 1.200	-
XP-L2	102+29 deg	Oval	94 %	0.770	-
H35C1 (LEMWA33)	100+20 deg	Oval	93 %	1.100	-
LUXEON A	92+20 deg	Oval	94 %	1.100	-
LUXEON C	sim: 13+86	Oval	sim: 93 %	sim: 1.570	-
NVSxx19A	100+20 deg	Oval	94 %	1.100	-
Oslon Square EC	92+21 deg	Oval	94 %	1.100	-
LH351Z	99+24 deg	Oval	94 %	1.100	-
Z5M1/Z5M2	99+22 deg	Oval	94 %	1.100	-

Relative intensity of CA13057&CA13058\_FLARE-MINI-AD-XBD

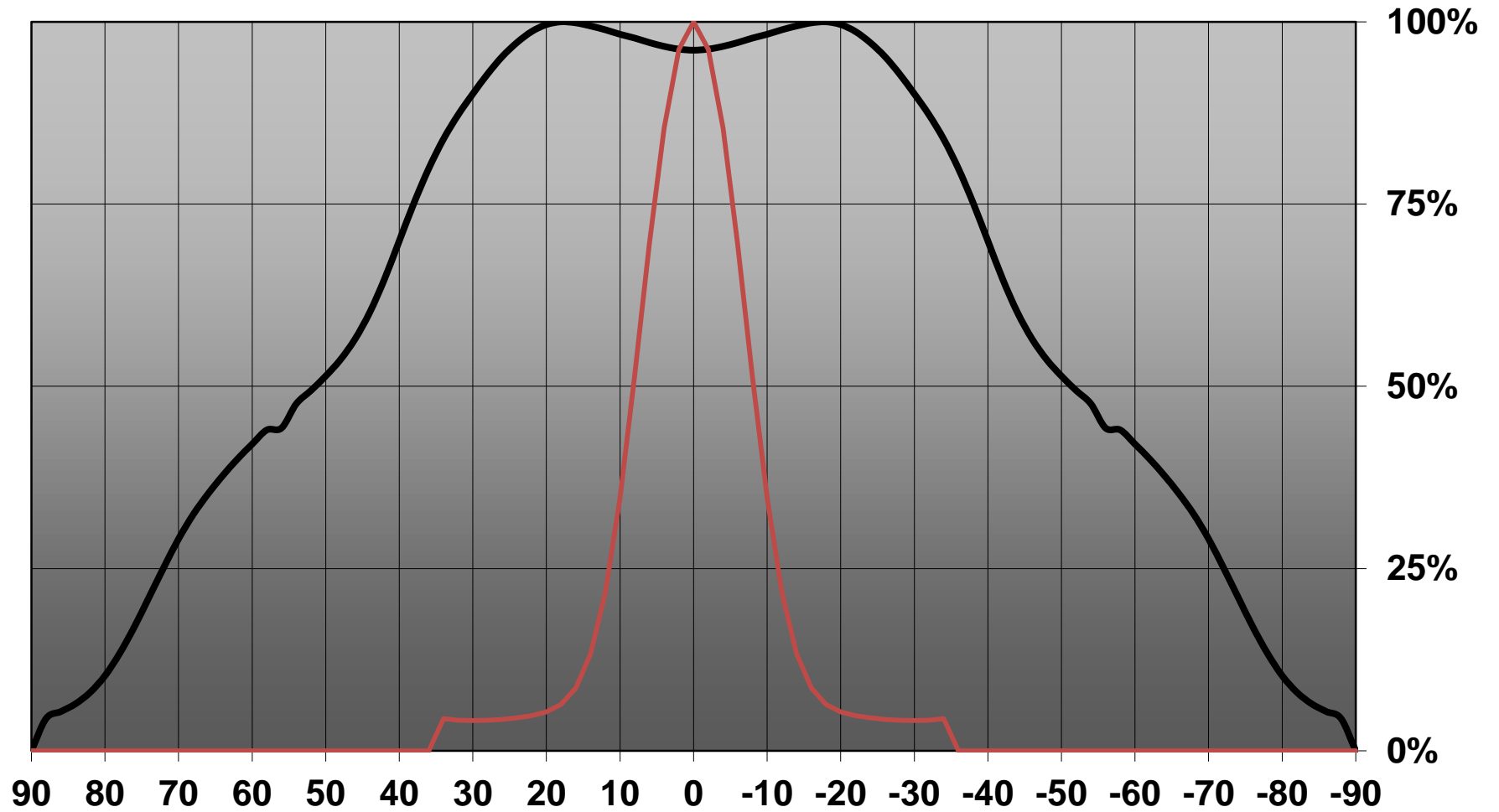

Relative intensity of CA13057&CA13058\_FLARE-MINI-AD-XPG

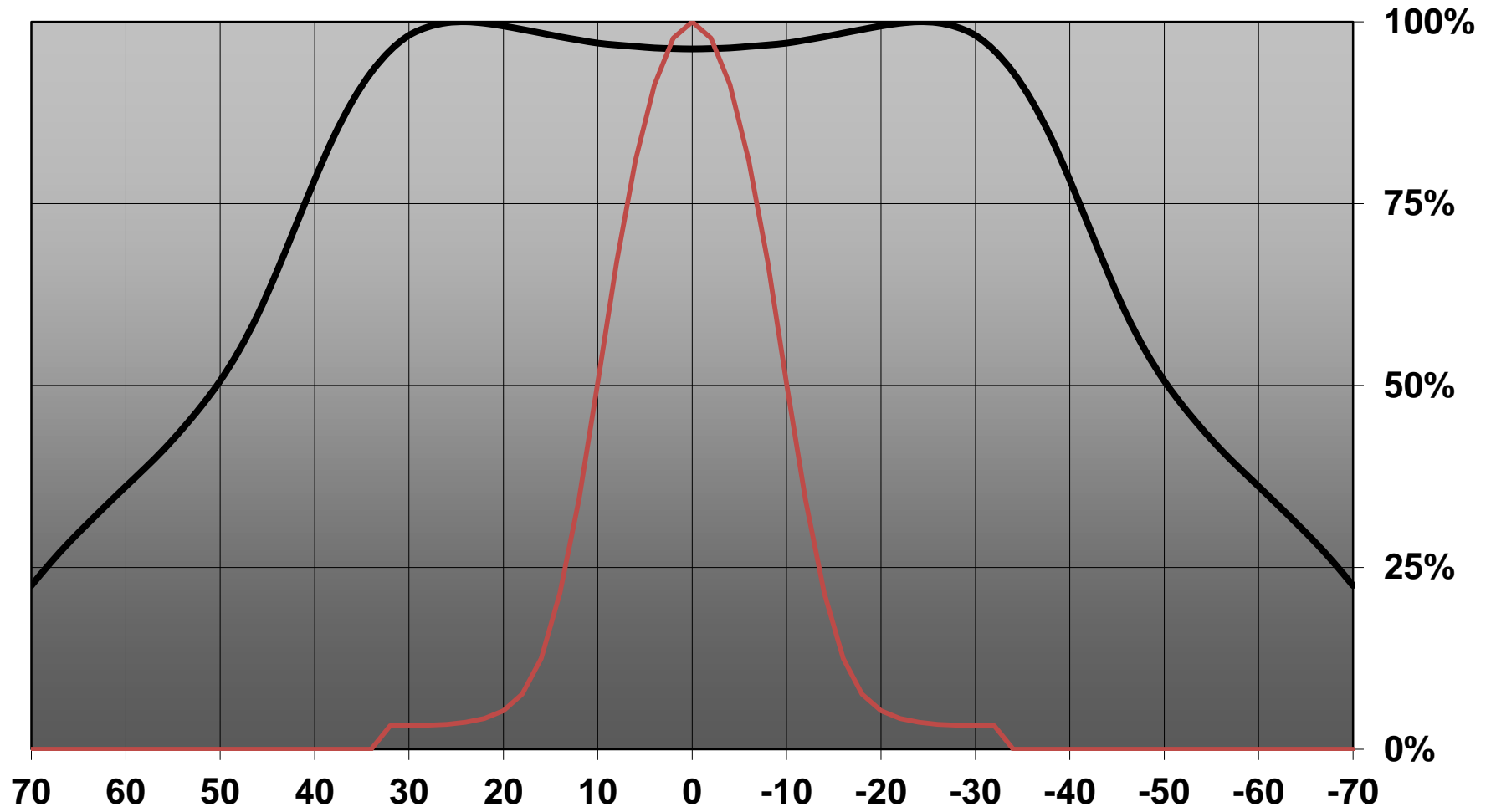

Relative intensity of CA13057&CA13058\_FLARE-MINI-AD-XTE

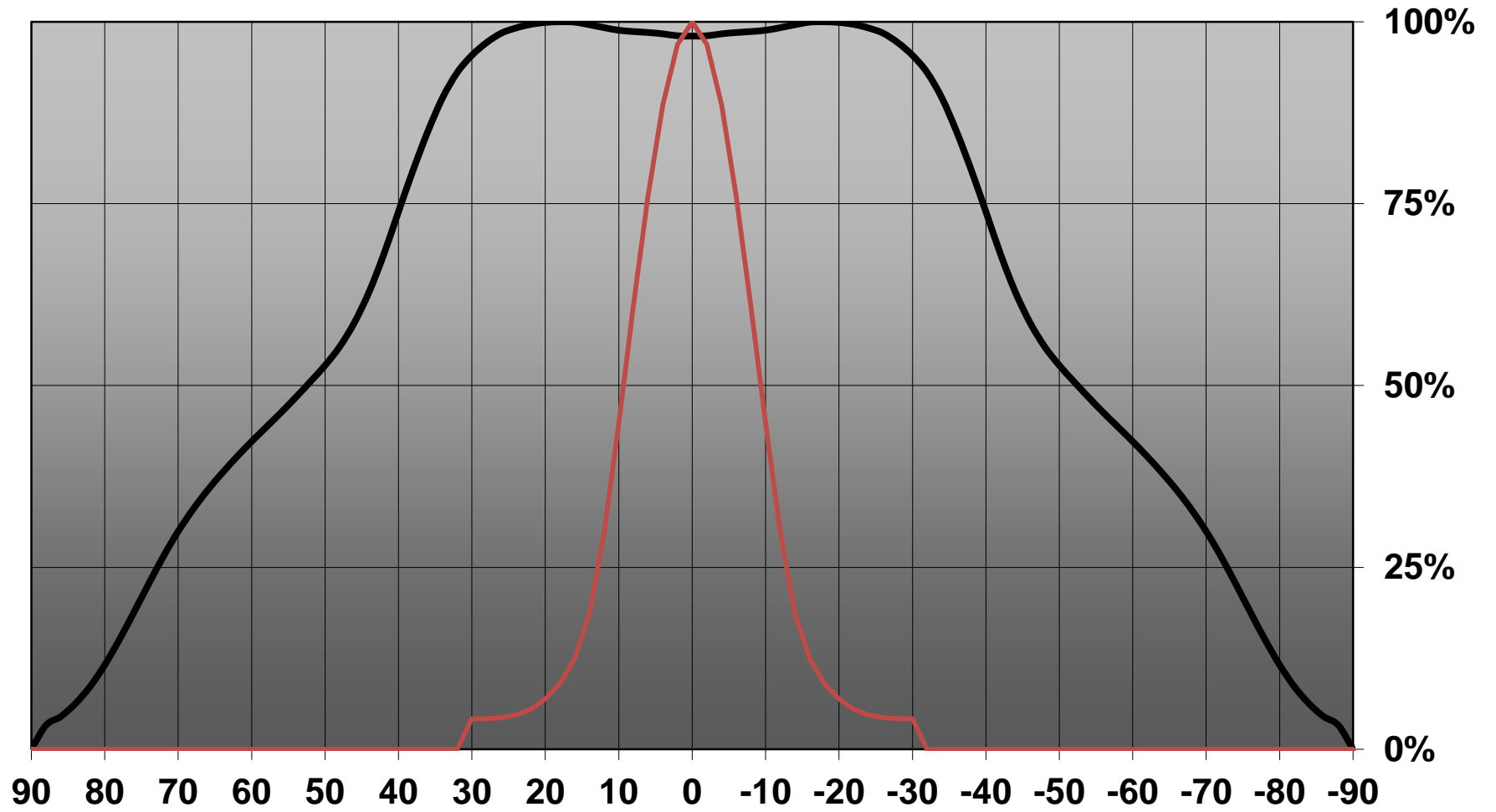

Relative intensity of CA13057&CA13058\_FLARE-MINI-AD-LuxA

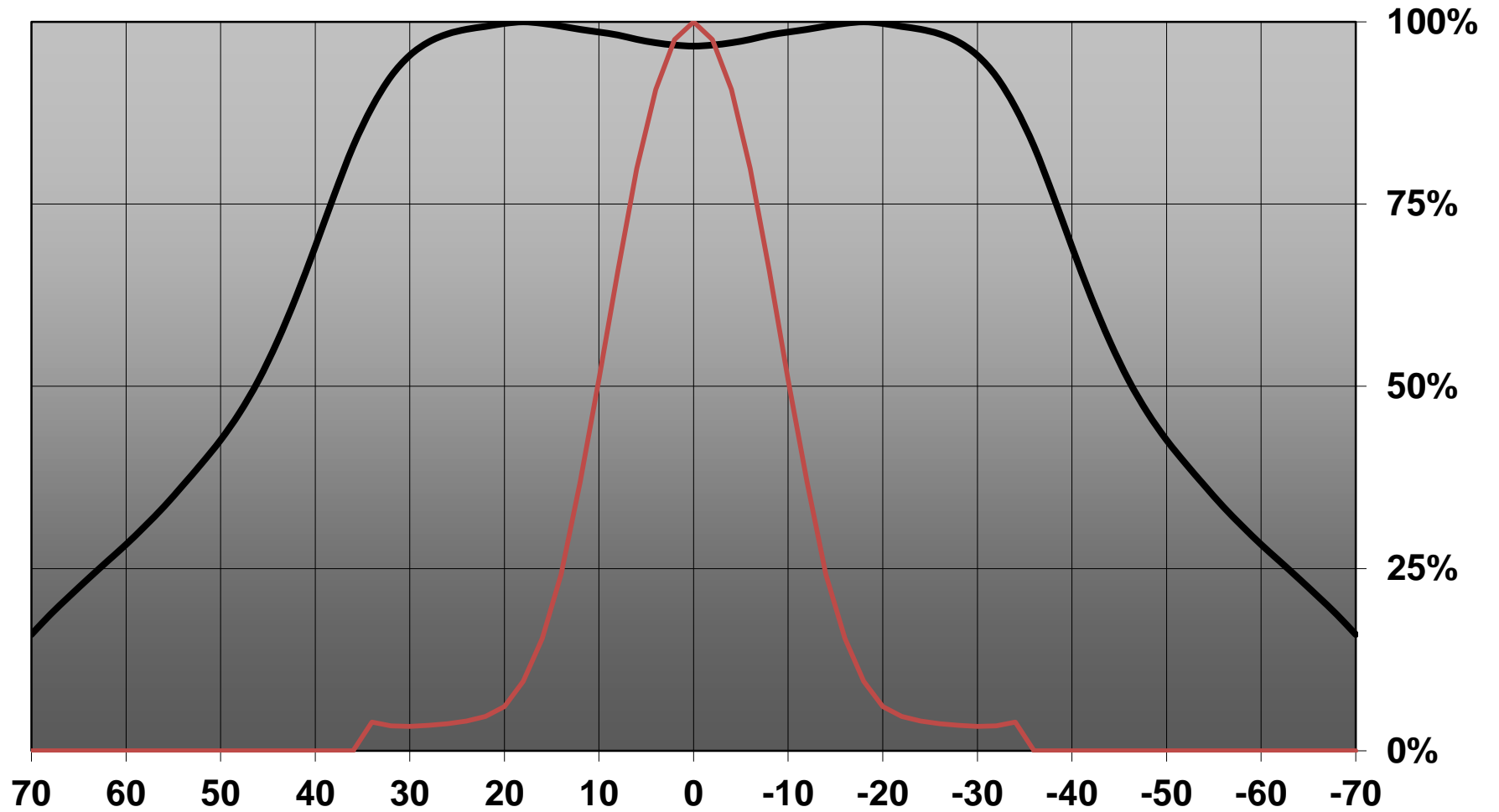

Relative intensity of CA13057&CA13058\_FLARE-MINI-AD-NVS19

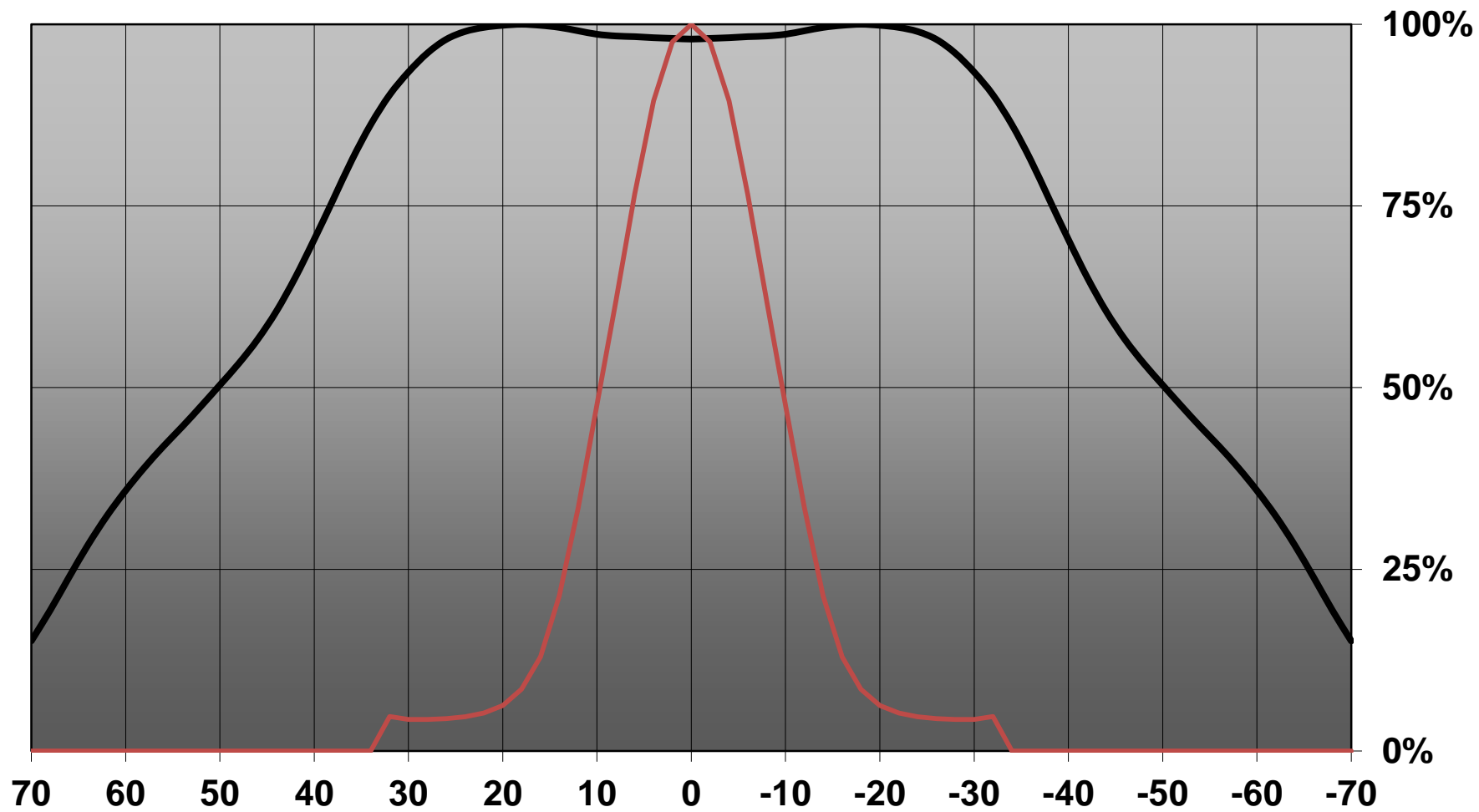

Relative intensity of CA13057&CA13058\_FLARE-MINI-AD-SQEC

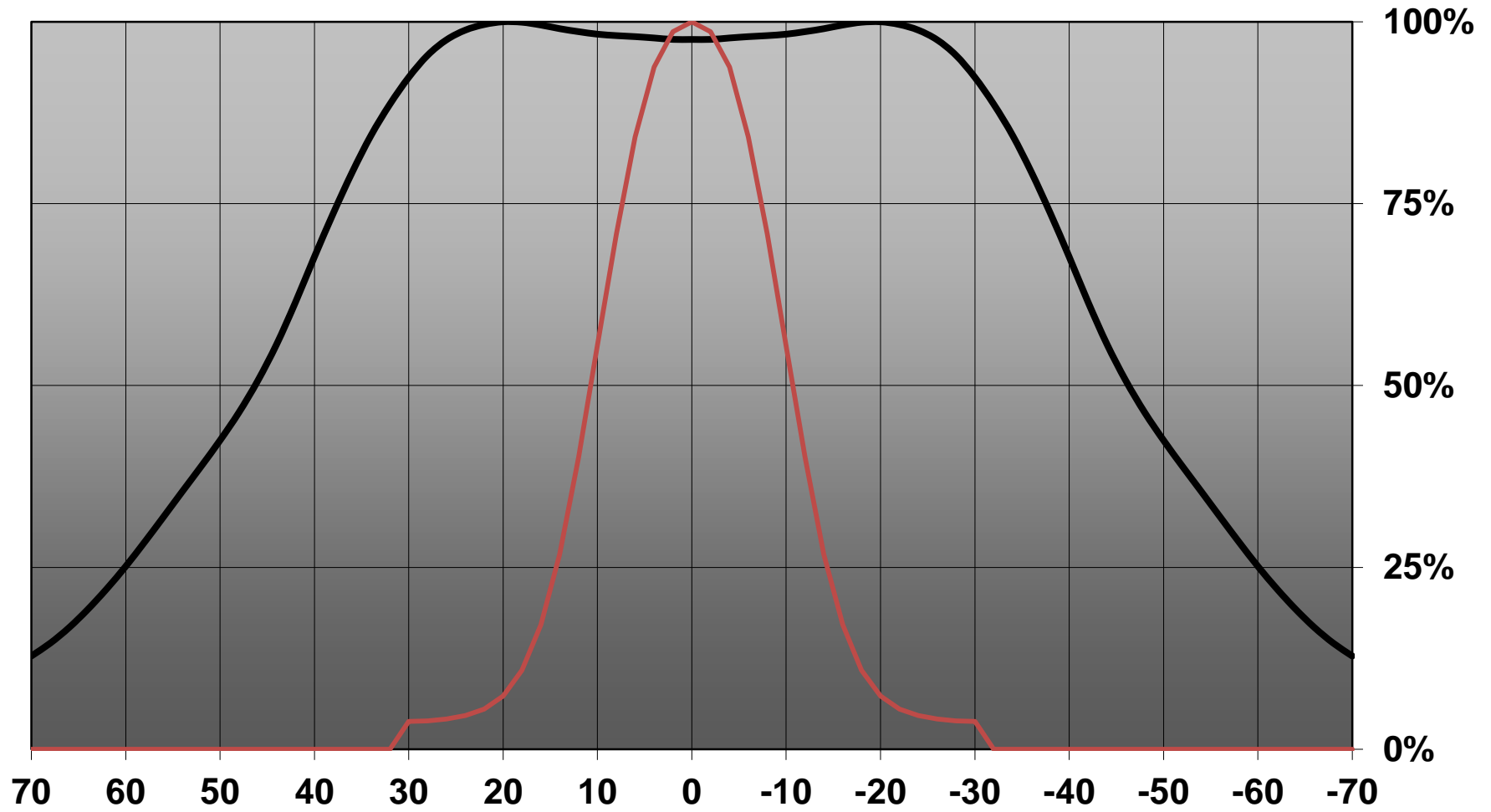

D

C

B

A

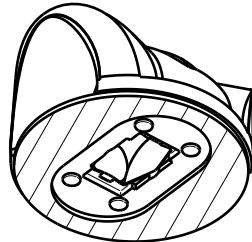
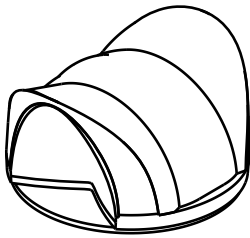

Led center position

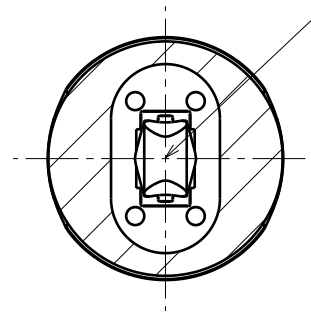

Beam direction

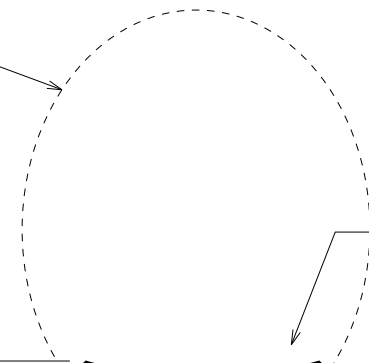
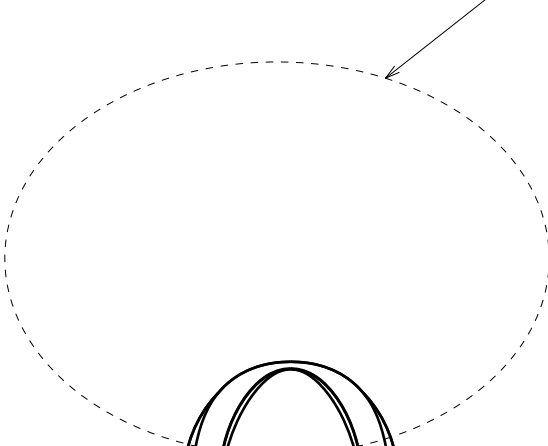

Lens

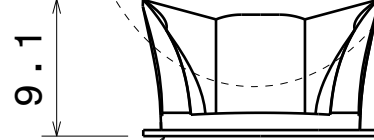

Tape 0.4mm

Ø16

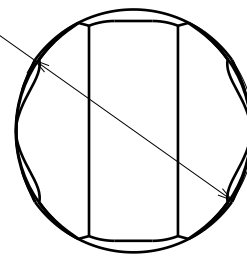

Material:  
Lens: PMMA  
Tape: PU Foam

Tolerances for dimensions:  
0-20mm tolerance value +/-0.1mm  
21-45mm tolerance value +/-0.2mm  
46-90mm tolerance value +/-0.3mm  
91-100mm tolerance value +/-0.4mm  
101-mm tolerance value +/-0.5mm

Note:  
Must use external positioning  
over light source.

This drawing is our property.  
It can't be reproduced  
or communicated without  
our written agreement.



Ledil Oy  
Salorankatu 10  
FIN 24240 SALO  
Finland

DRAWING TITLE

Datasheet Flare-Mini-AD Assy

DRAWN BY

jk

DATE

20151005

CHECKED BY

DATE

SIZE

A4

DRAWING NUMBER

CA13057

REV

DESIGNED BY

pl

DATE

27.02.2012

SCALE

2:1

WEIGHT 1,3 g

SHEET

1/1

D

A



Luminaire: LEDiL Oy CA13057\_FLARE-MINI-AD\_(XP-G)

Lamps: 1 x Cree\_XP-G\_(XPGWHT-L1-CWPI-00BE7)\_67.23lm@250mA\_P=0.771066W\_I=249.9mA

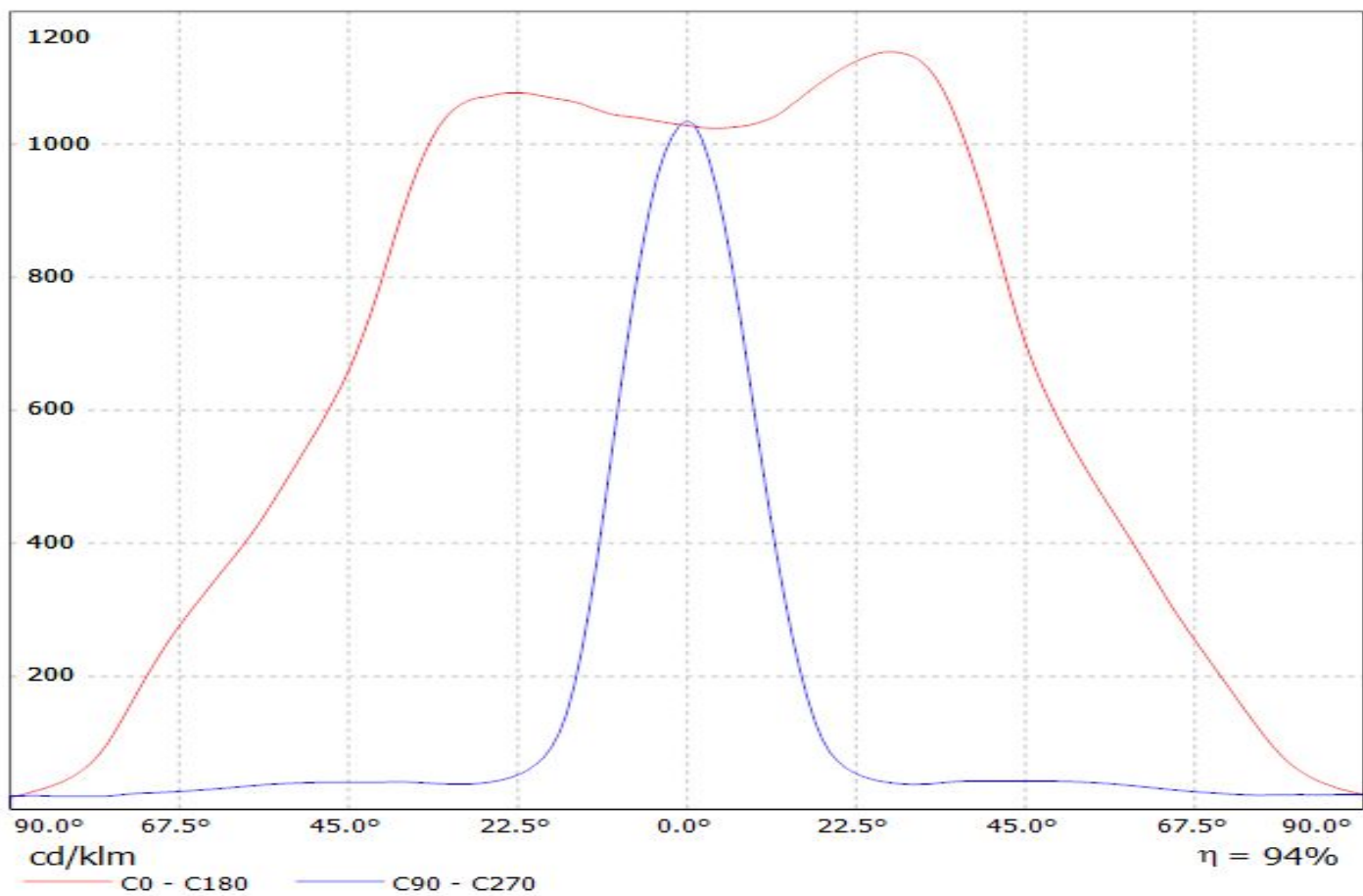

Luminaire: Ledil Oy CA13058\_FLARE-MINI-AD-PIN (Cree XT-E 98lm @ 250mA) Efficiency=94%  
Lamps: 1 x Cree XT-E 98lm @ 250mA

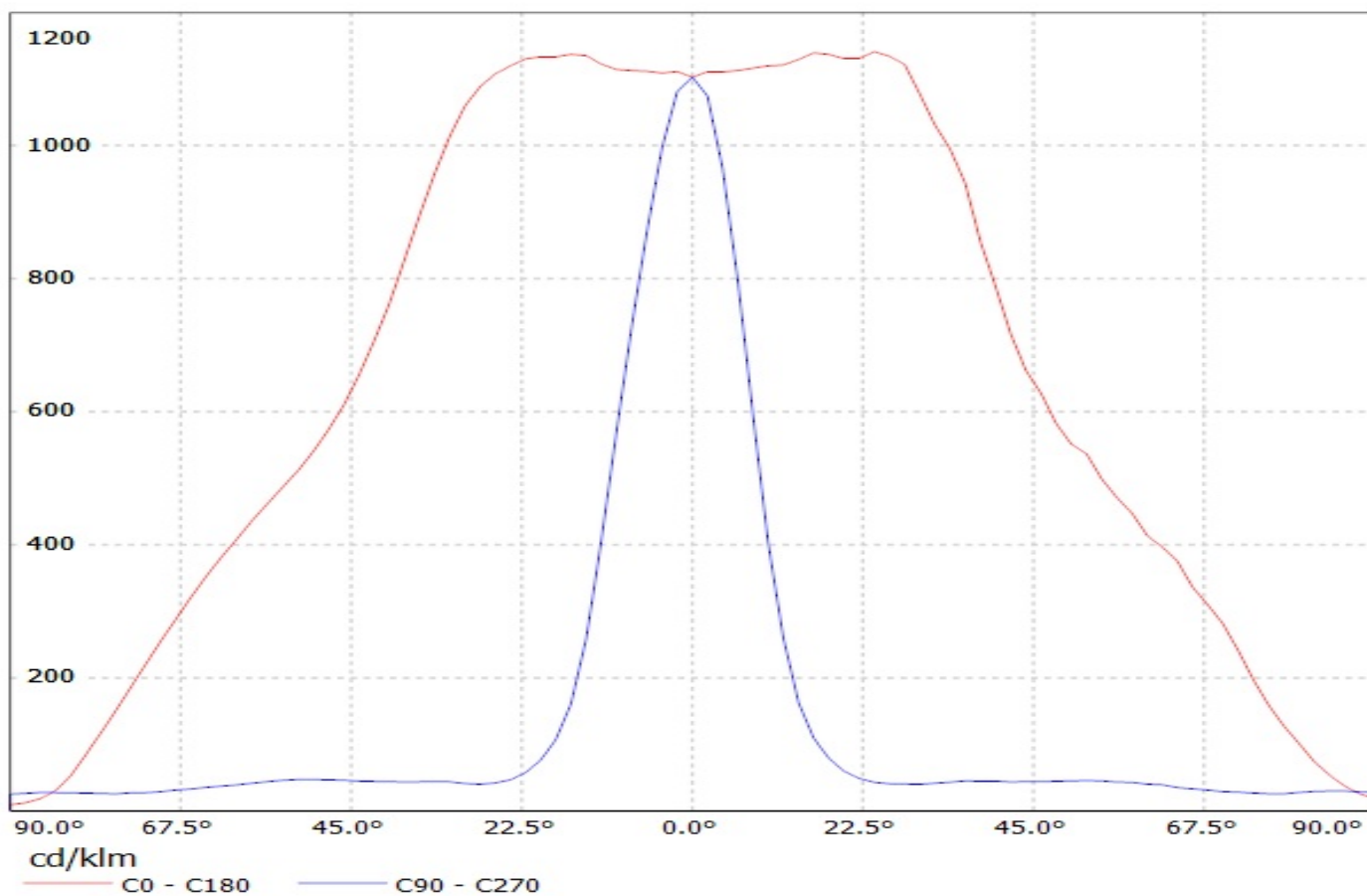

Luminaire: Ledil Oy CA13057\_FLARE-MINI-AD (CREE XP-E2 92 lm & 250 mA) Efficiency=94%  
Lamps: 1 x CREE XP-E2 92 lm & 250 mA

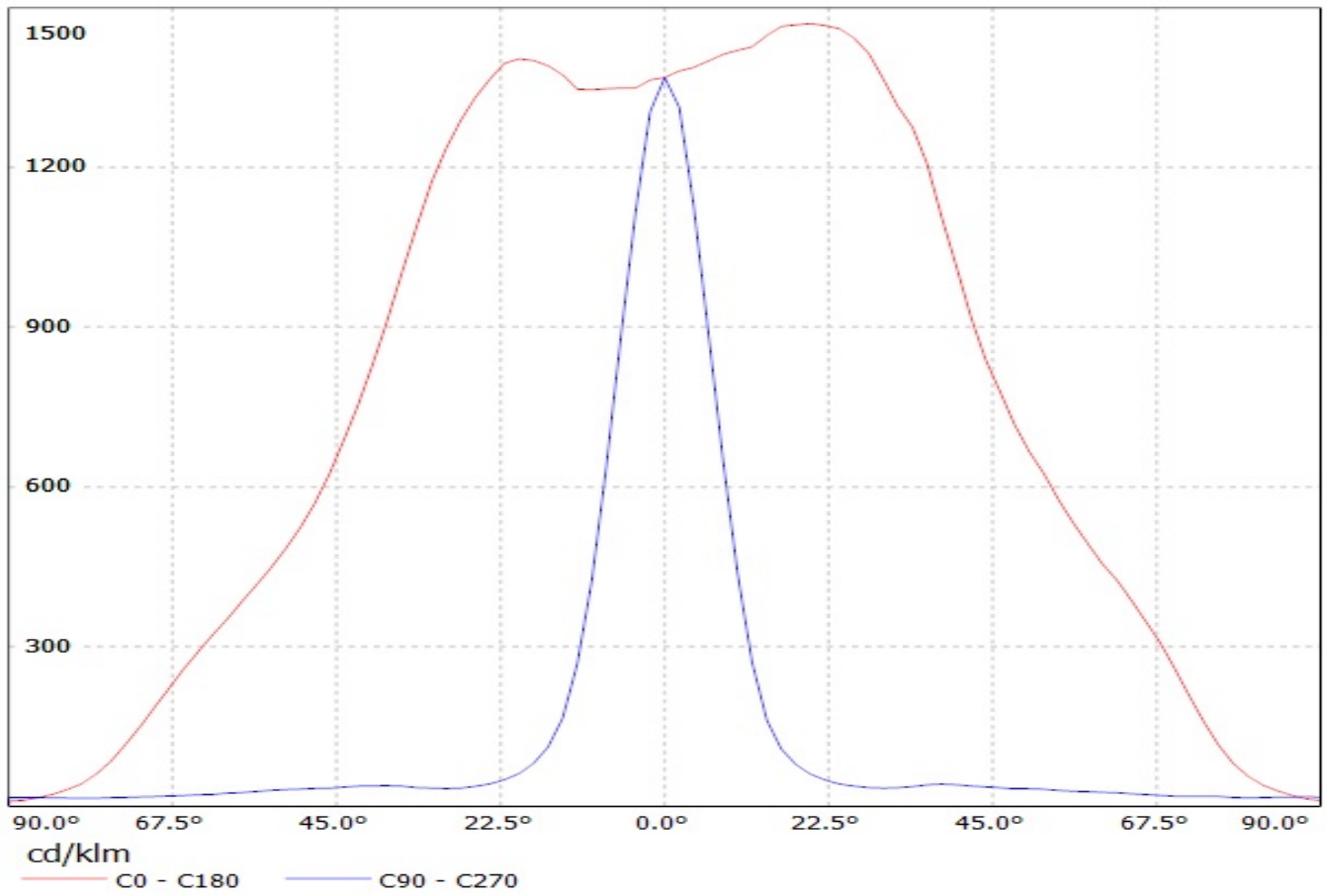

Luminaire: Ledil Oy CA13057\_FLARE-MINI-AD (CREE XP-G2 99 lm @ 250 mA) Efficiency=94%  
Lamps: 1 x CREE XP-G2 99 lm @ 250 mA

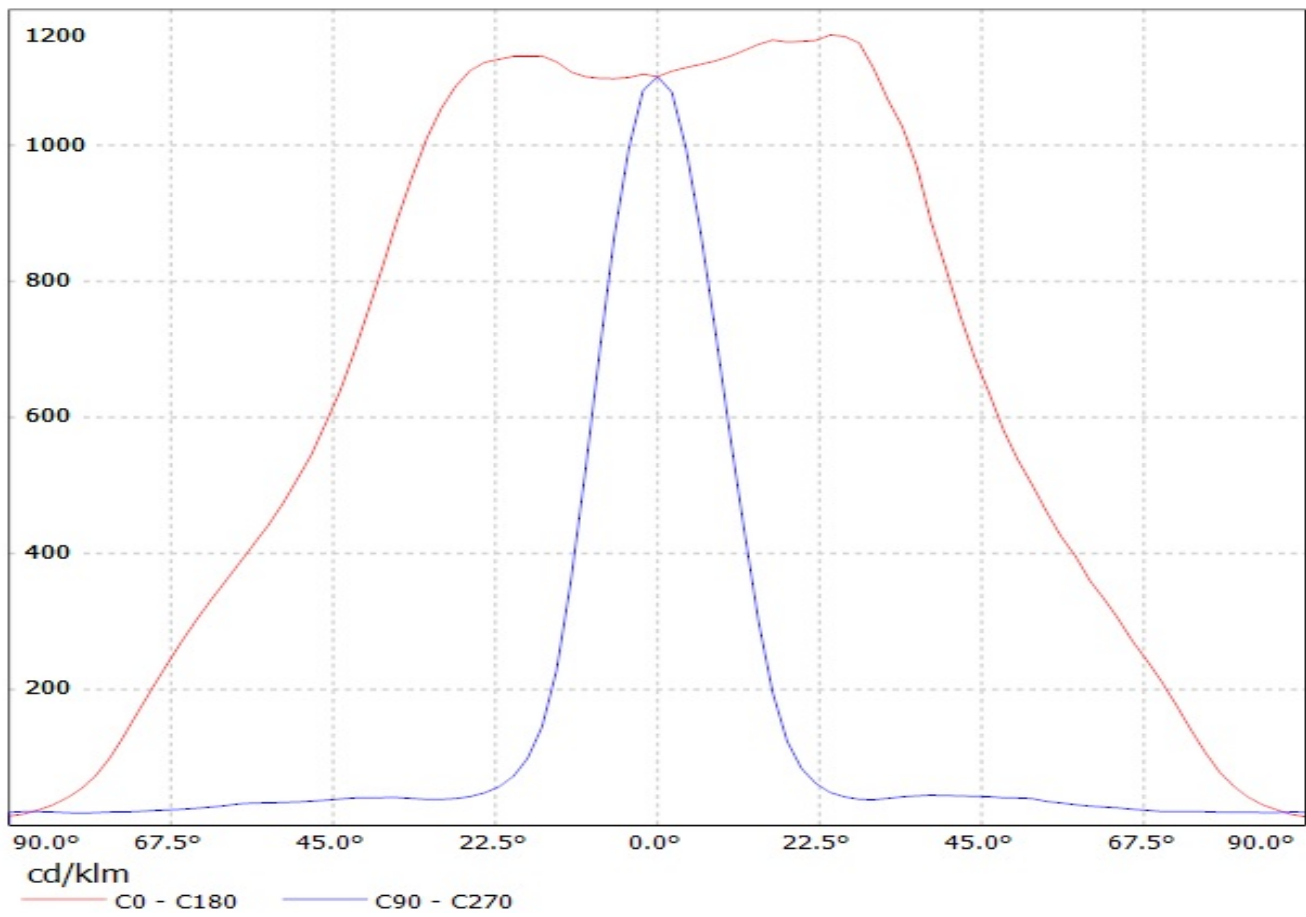

Luminaire: LEDiL Oy CA13057\_FLARE-MINI-AD\_(XP-L)  
Lamps: 1 x Cree\_XP-L\_125.168lm@250mA\_P=0.73818W\_I=249.9mA

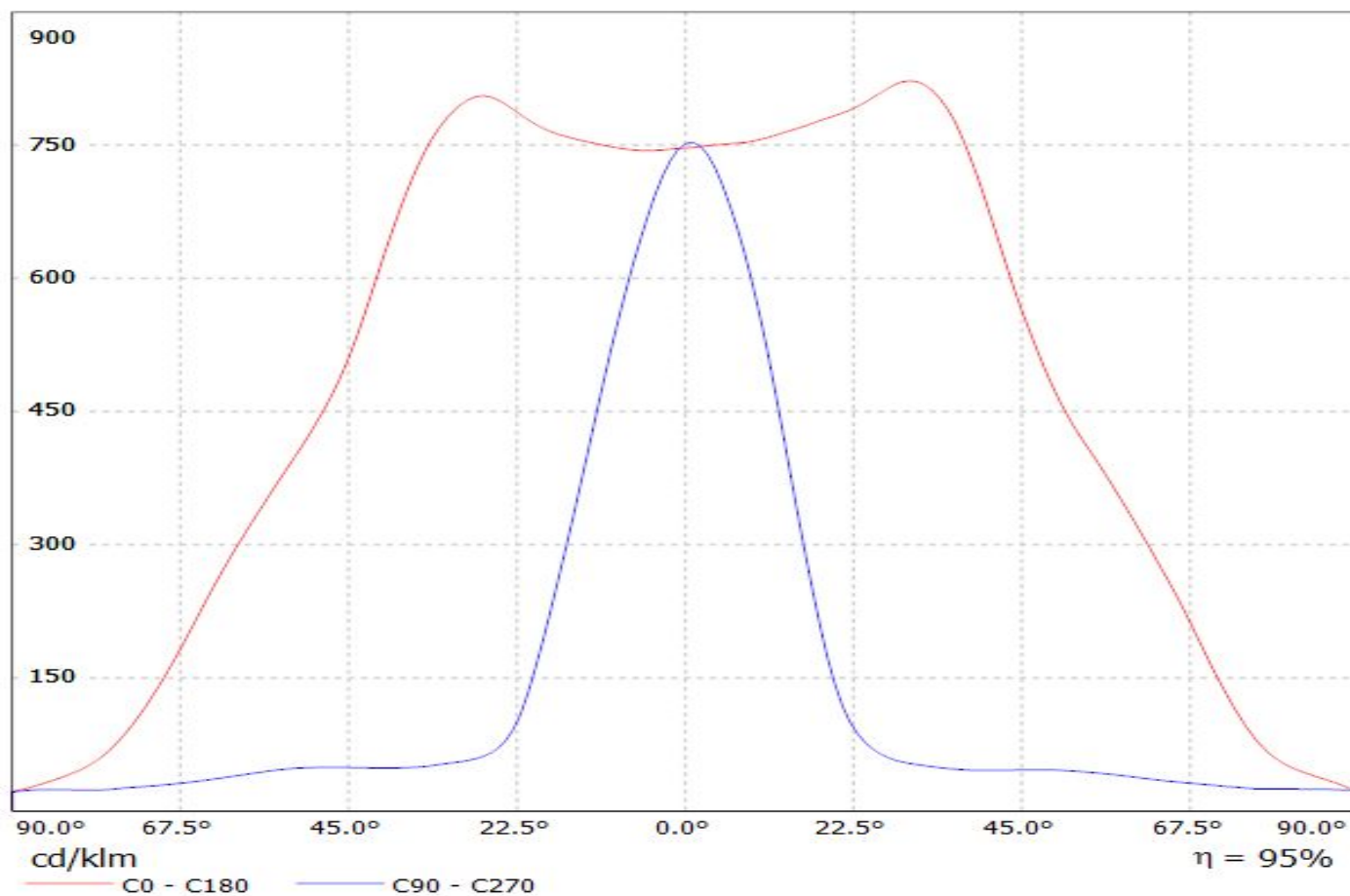

Luminaire: Ledil Oy CA13057\_FLARE-MINI-AD\_(XHP35\_HD)\_SIMULATED  
Lamps: 1 x Cree XHP35 HD

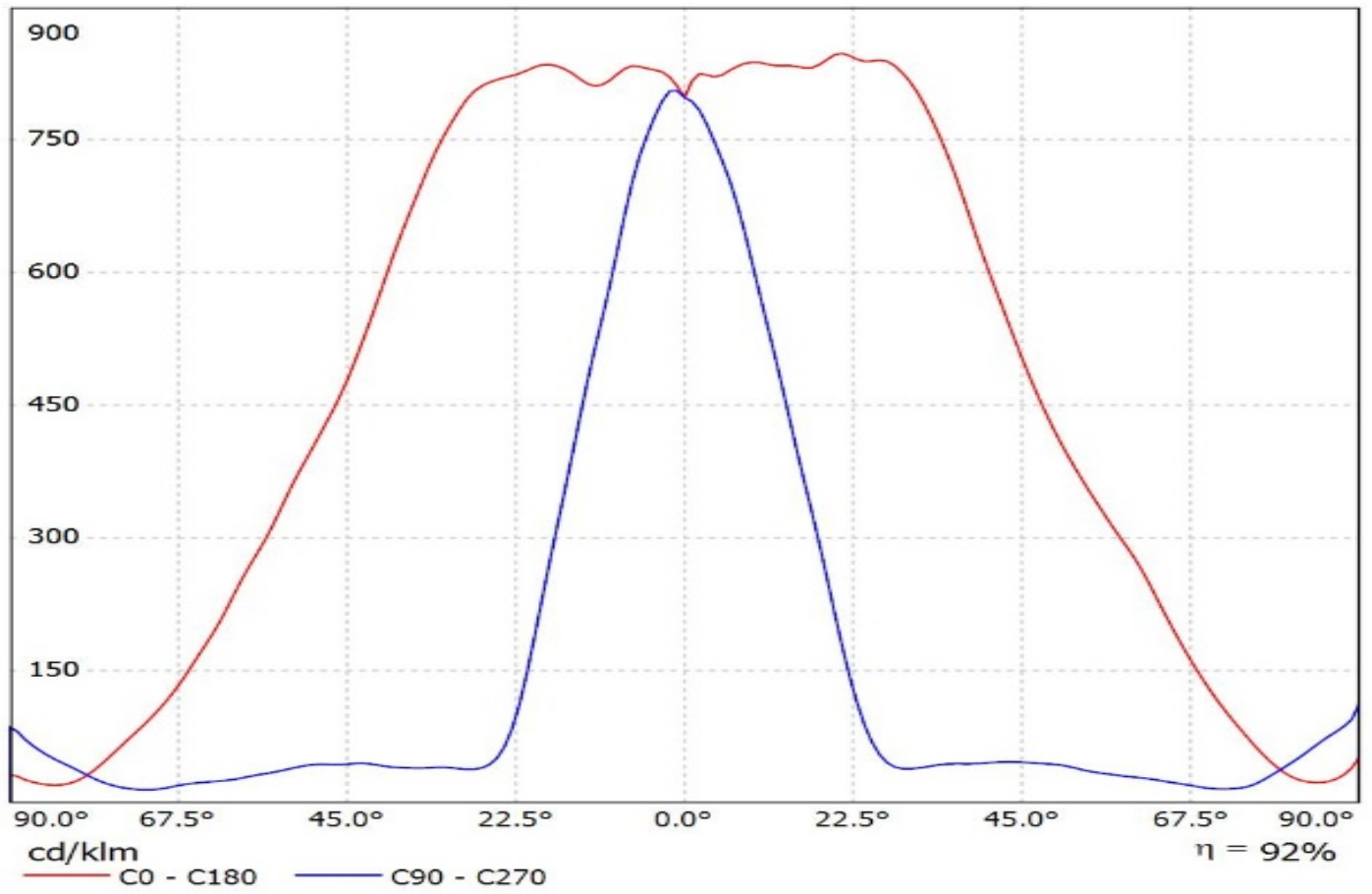

Luminaire: Ledil Oy CA13057\_FLARE-MINI-AD\_(XHP35\_HI)\_SIMULATED  
Lamps: 1 x Cree XHP35 HI

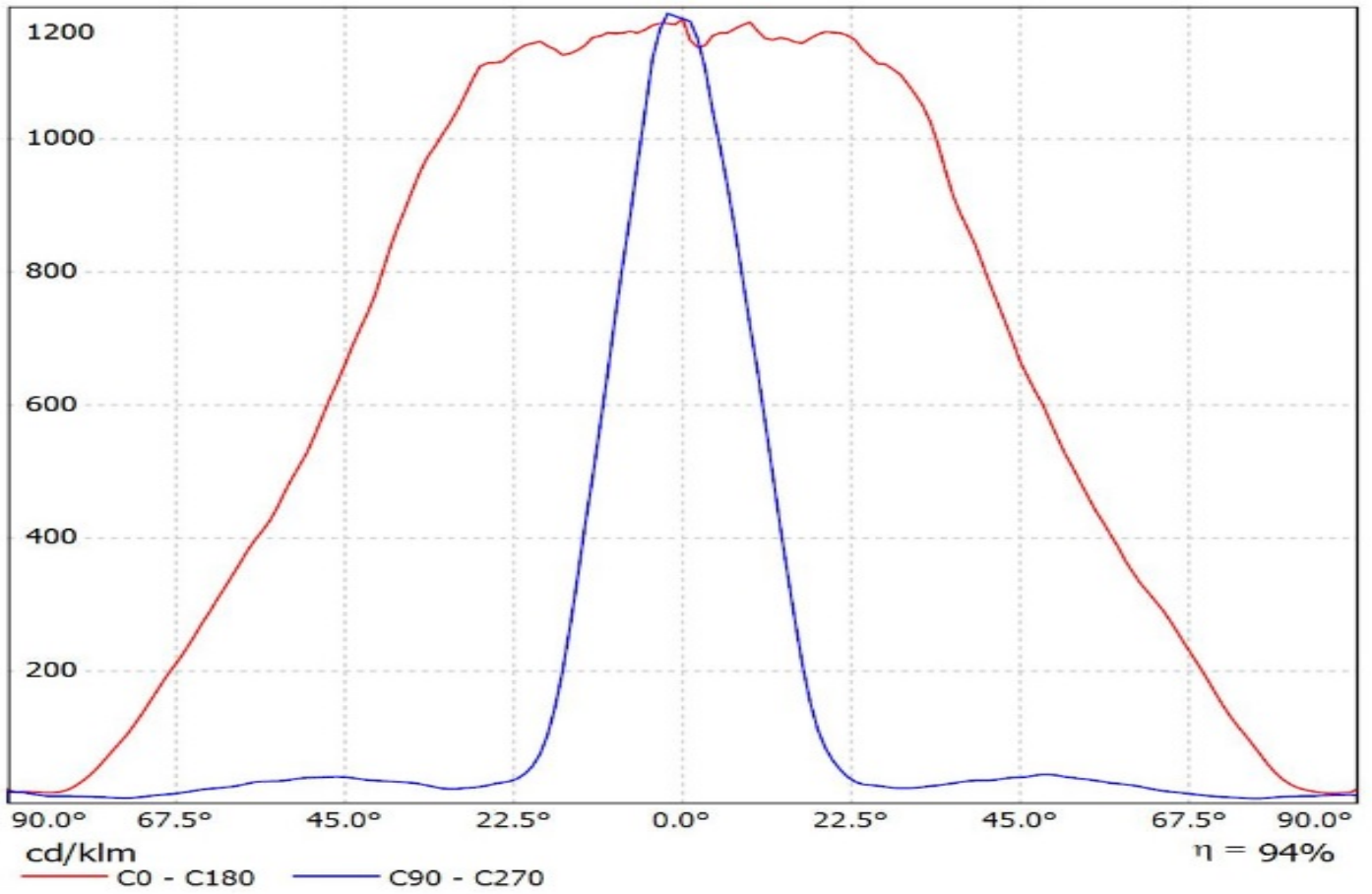

Luminaire: Ledil CA13057\_FLARE-MINI-AD\_(XP-L2)

Lamps: 1 x Cree\_XP-L2\_(XPLWT-00-0000-000HU630G)\_115.505lm@250mA\_P=0.72165W\_I=0.25A

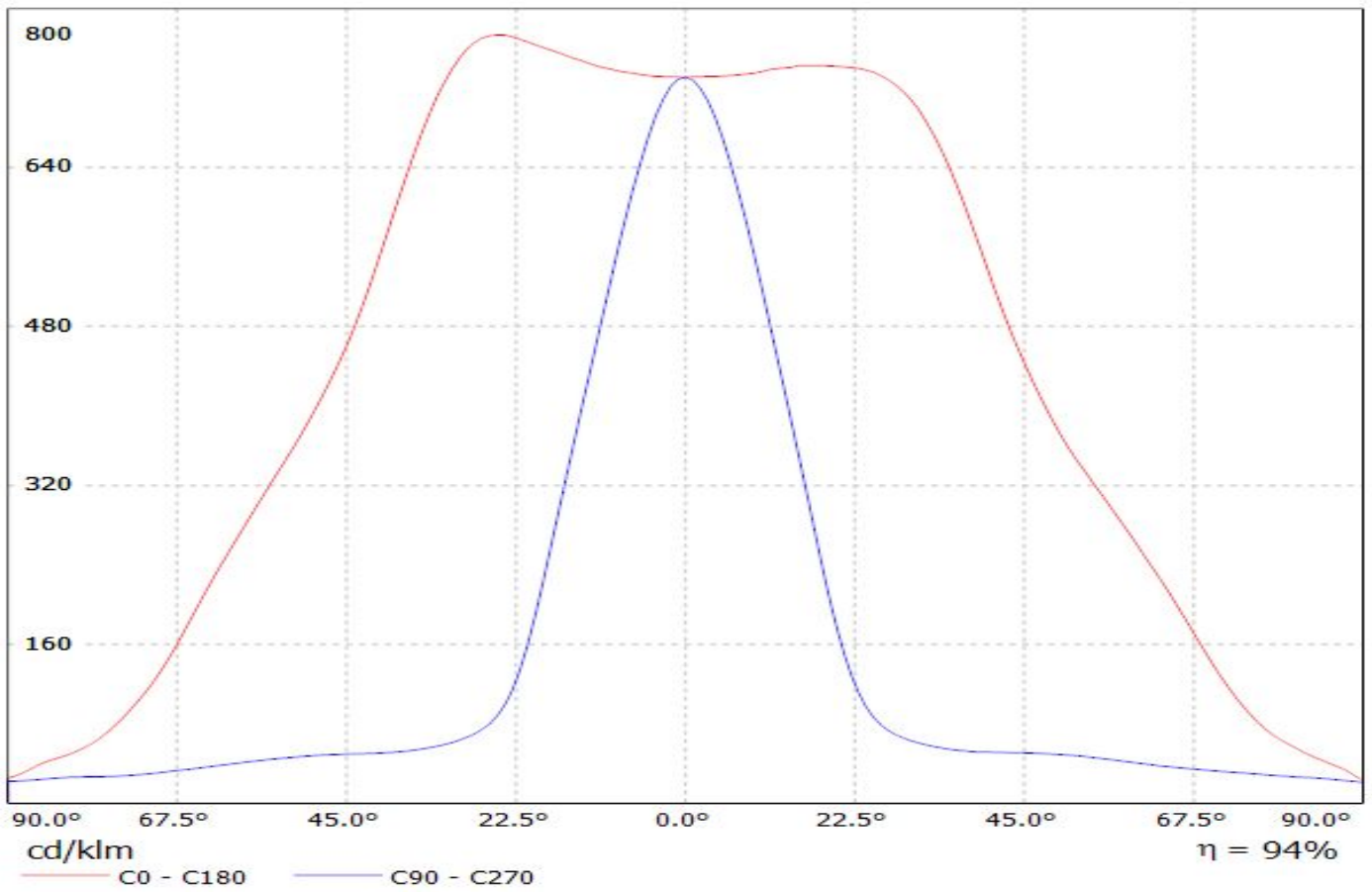



Luminaire: LEDiL Oy CA13057\_FLARE-MINI-AD\_(LG-3535-CERAMIC-GEN2) Eff.93%  
Lamps: 1 x LG-3535-CERAMIC-GEN2\_116.256lm@250mA\_P=0.754973W\_CCT=6235K\_I=249.9mA

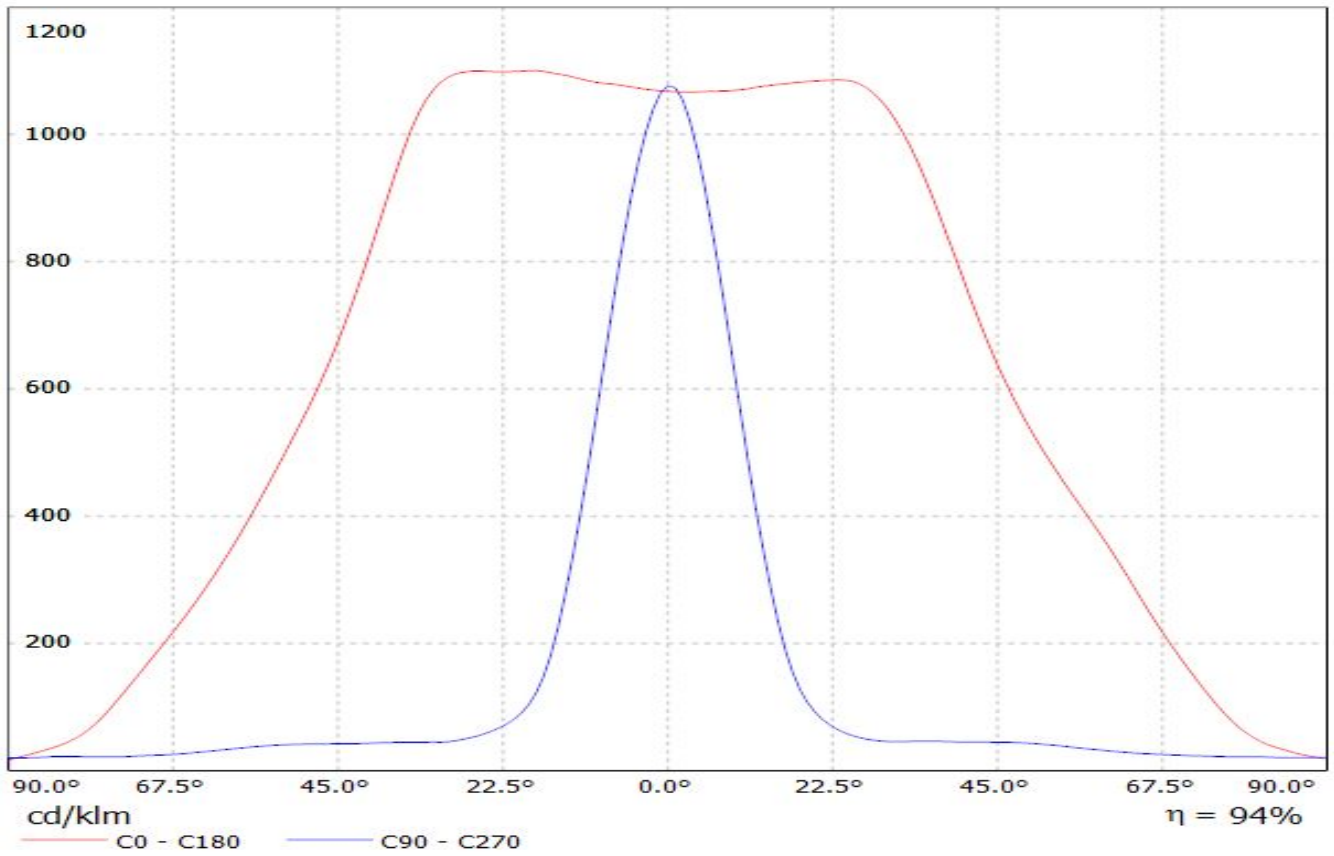

Luminaire: Ledil Oy CA13057\_FLARE-MINI-AD\_(LH351Z) Efficiency=94%  
Lamps: 1 x Samsung LH351Z (90.14lm @ 250mA) CCT=6500K P=0.7W I=250mA

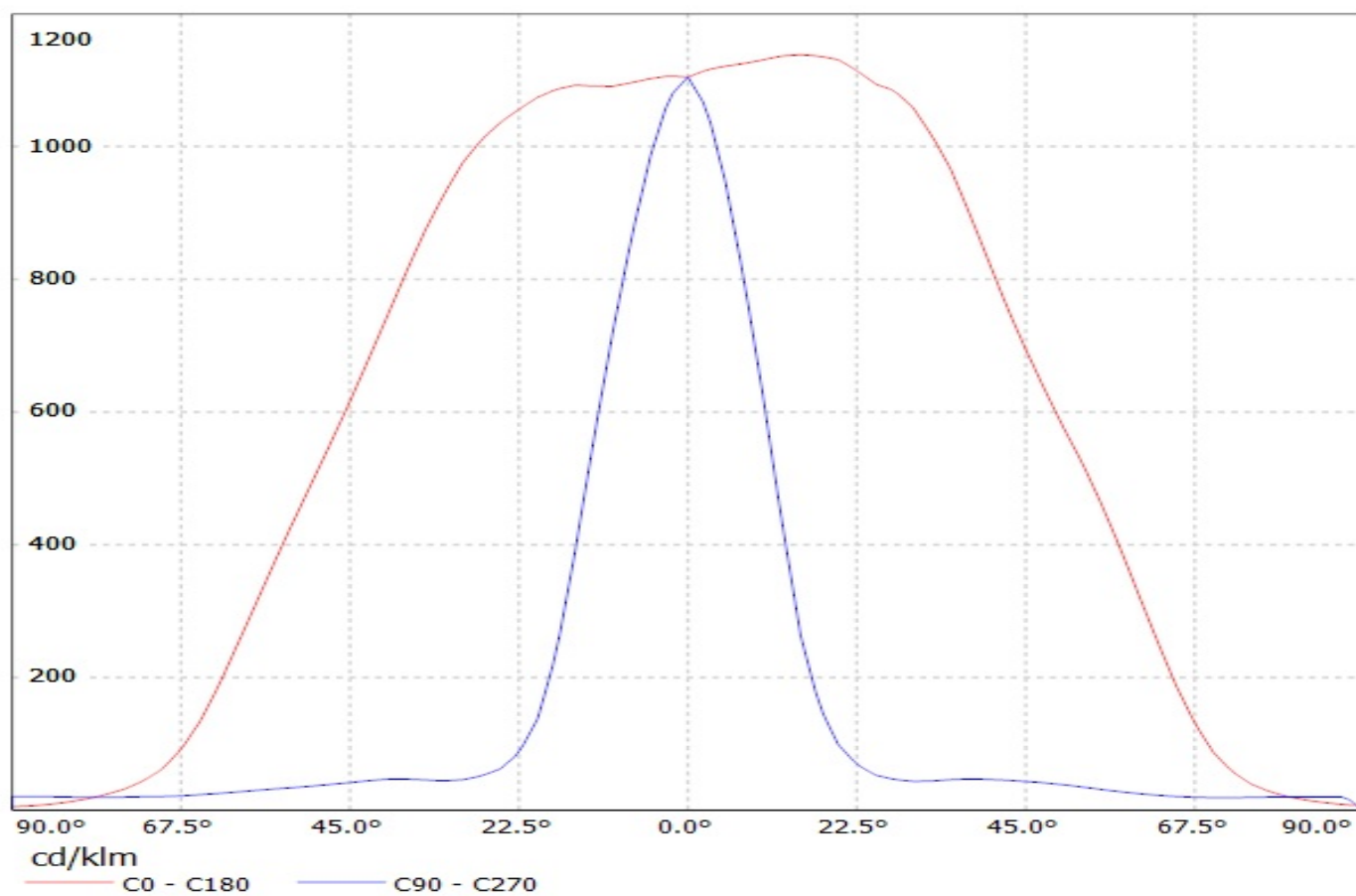

Luminaire: LEDil Oy CA13057\_FLARE-MINI-AD\_(Z5M1) Efficiency=94%  
Lamps: 1 x Seoul Z5M1 (SZ5M1-W0-C8/W1-A5-G) 108lm @ 250mA CCT=9100K P=0.8W I=250mA

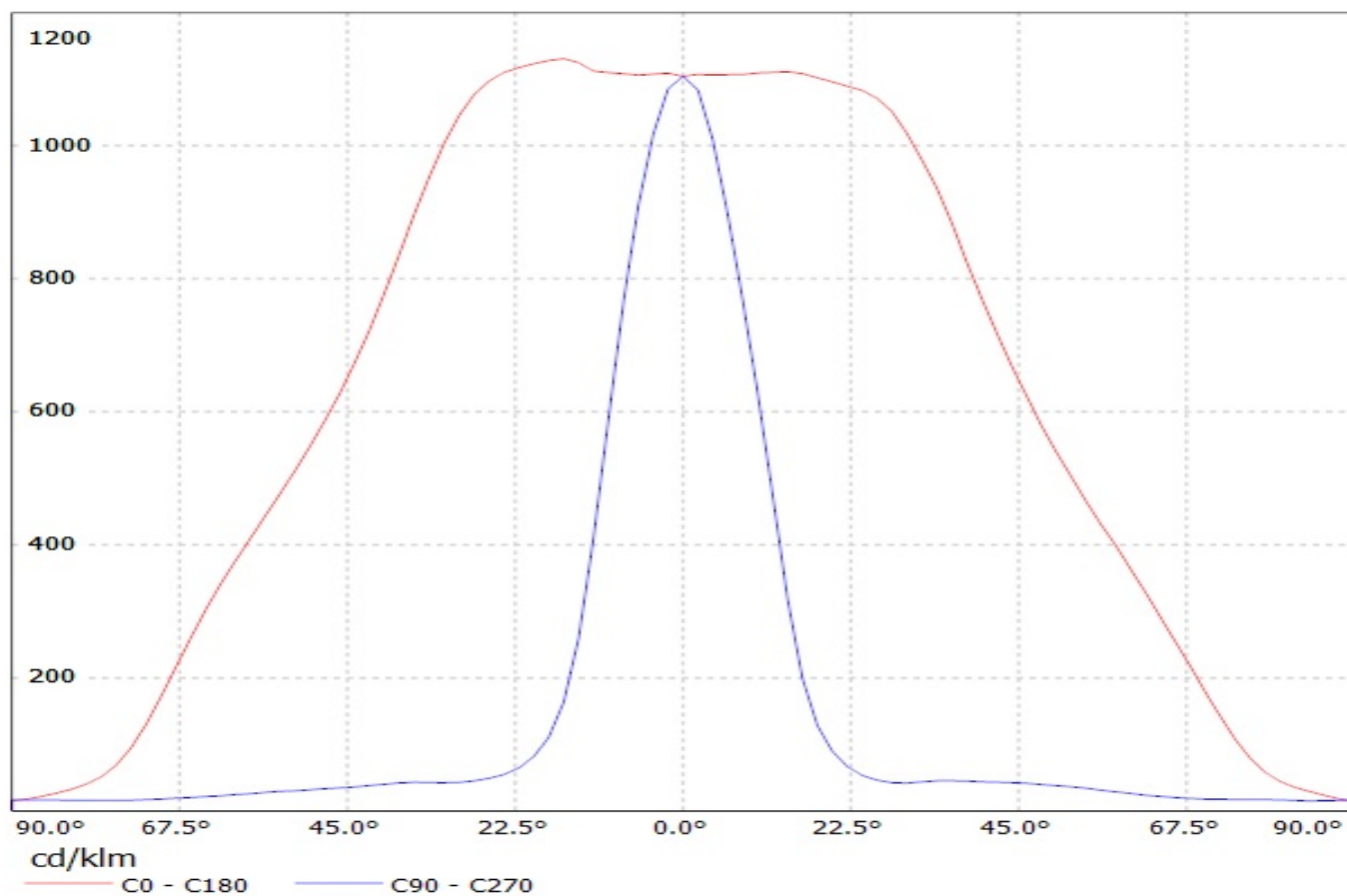

Luminaire: LEDiL Oy CA13057\_FLARE-MINI-AD\_(XP-G)

Lamps: 1 x Cree\_XP-G\_(XPGWHT-L1-CWPI-00BE7)\_67.23lm@250mA\_P=0.771066W\_I=249.9mA

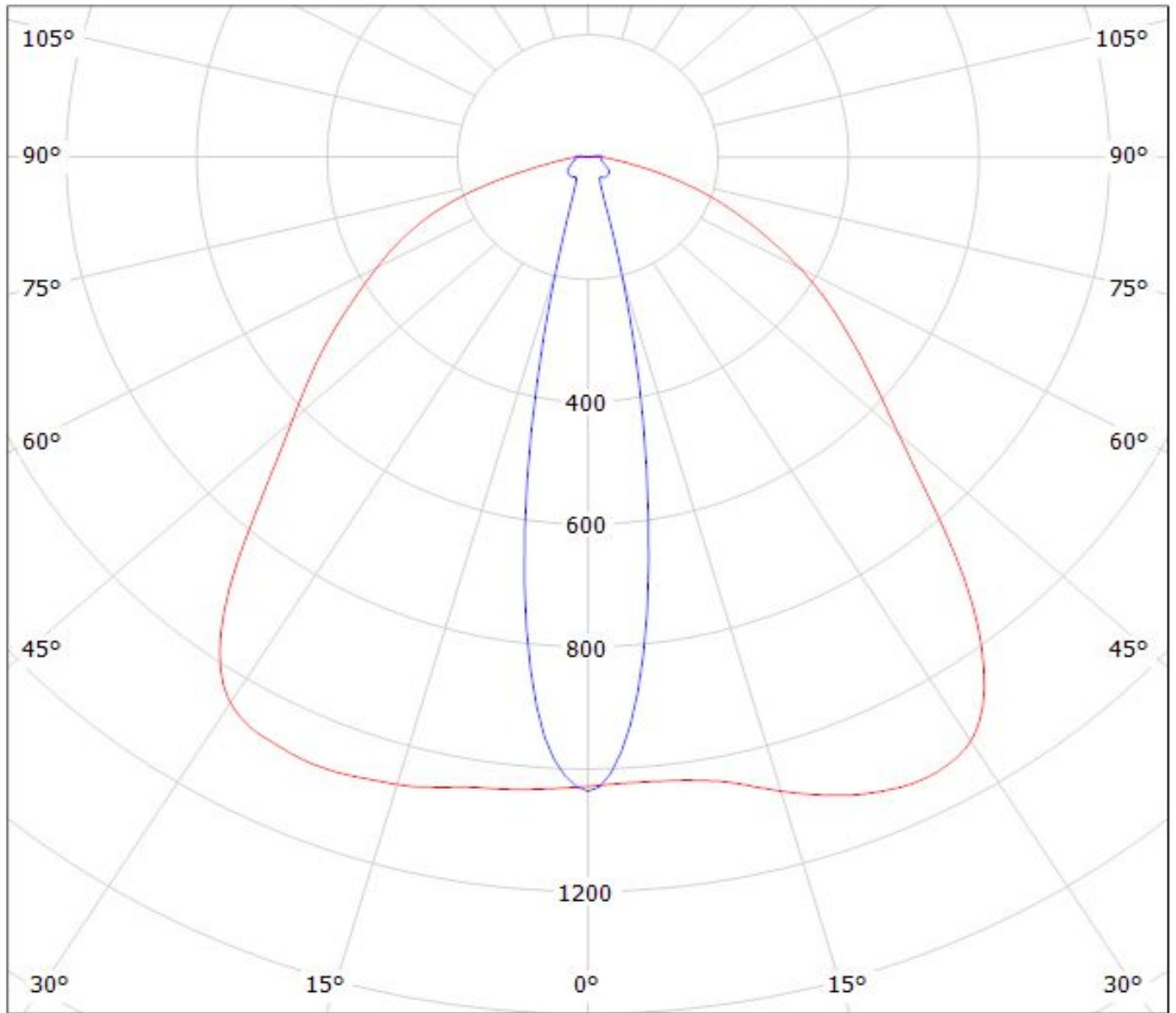

cd/klm

— C0 - C180

— C90 - C270

$\eta = 94\%$

Luminaire: Ledil Oy CA13058\_FLARE-MINI-AD-PIN (Cree XT-E 98lm @ 250mA) Efficiency=94%  
Lamps: 1 x Cree XT-E 98lm @ 250mA

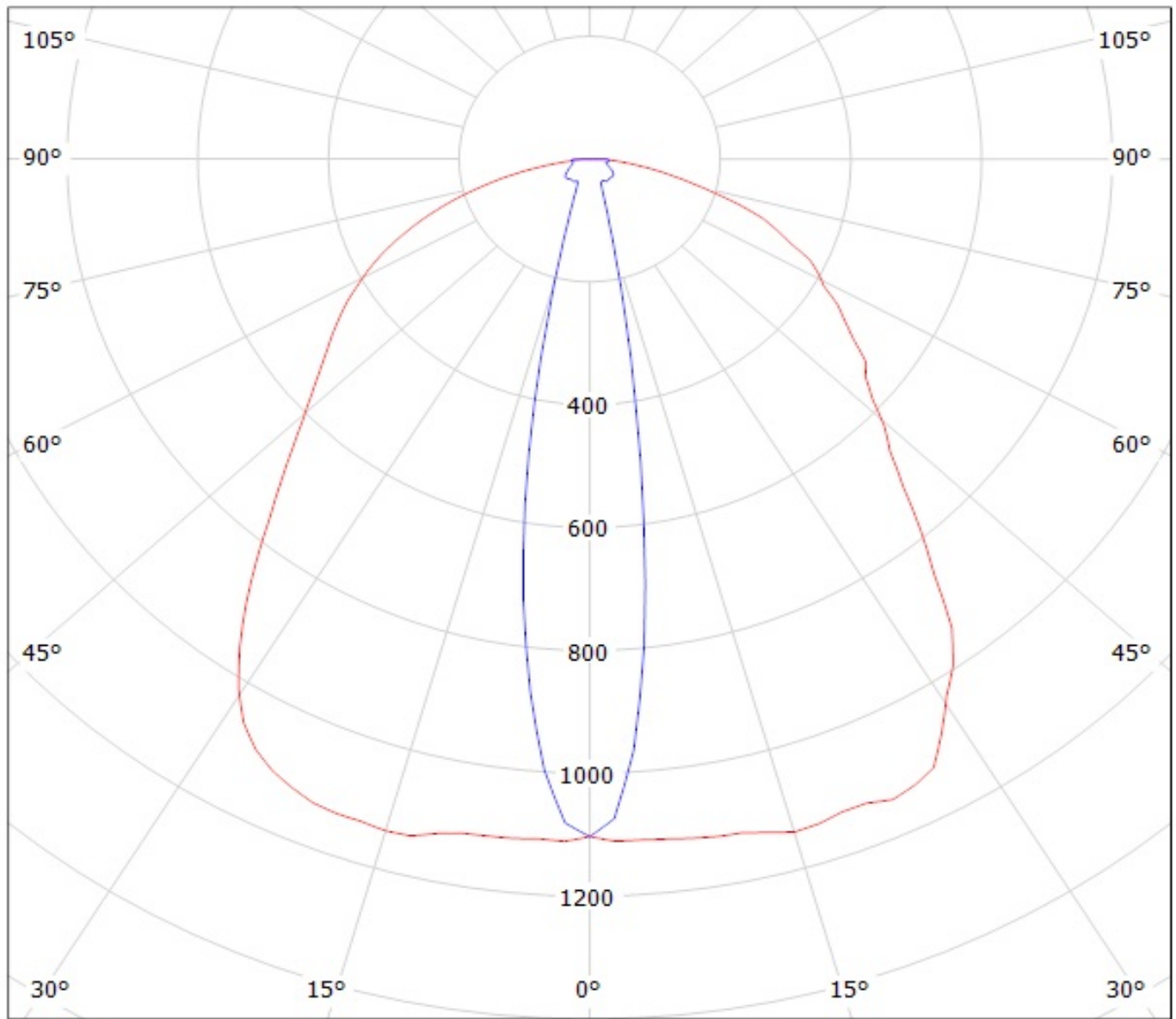

cd/klm

— C0 - C180    — C90 - C270

Luminaire: Ledil Oy CA13057\_FLARE-MINI-AD (CREE XP-E2 92 lm & 250 mA) Efficiency=94%  
Lamps: 1 x CREE XP-E2 92 lm & 250 mA

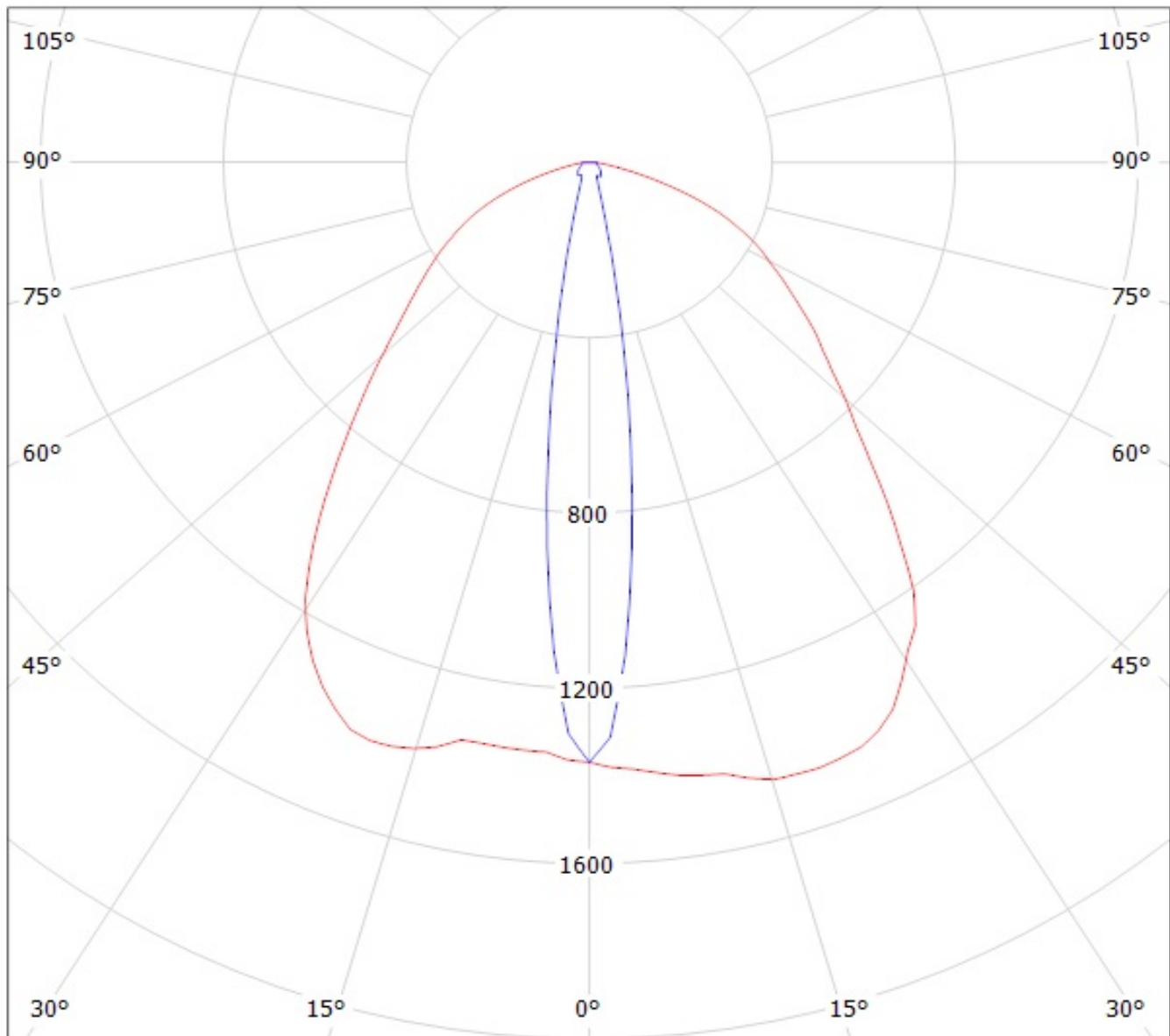

cd/klm

— C0 - C180    — C90 - C270

Luminaire: Ledil Oy CA13057\_FLARE-MINI-AD (CREE XP-G2 99 lm @ 250 mA) Efficiency=94%  
Lamps: 1 x CREE XP-G2 99 lm @ 250 mA

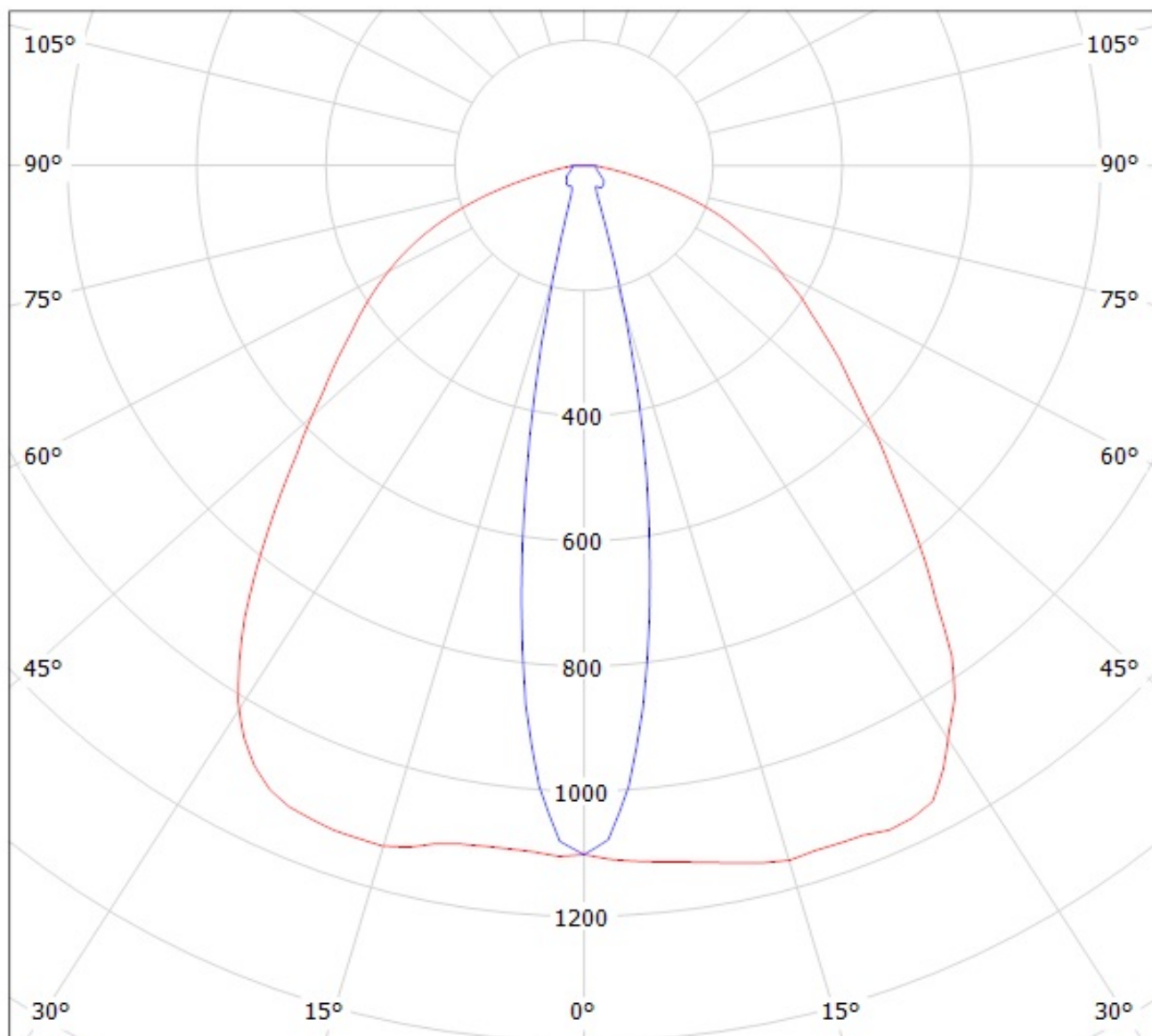

cd/klm

— C0 - C180 — C90 - C270



Luminaire: LEDiL Oy CA13057\_FLARE-MINI-AD\_(XP-L)  
Lamps: 1 x Cree\_XP-L\_125.168lm@250mA\_P=0.73818W\_I=249.9mA

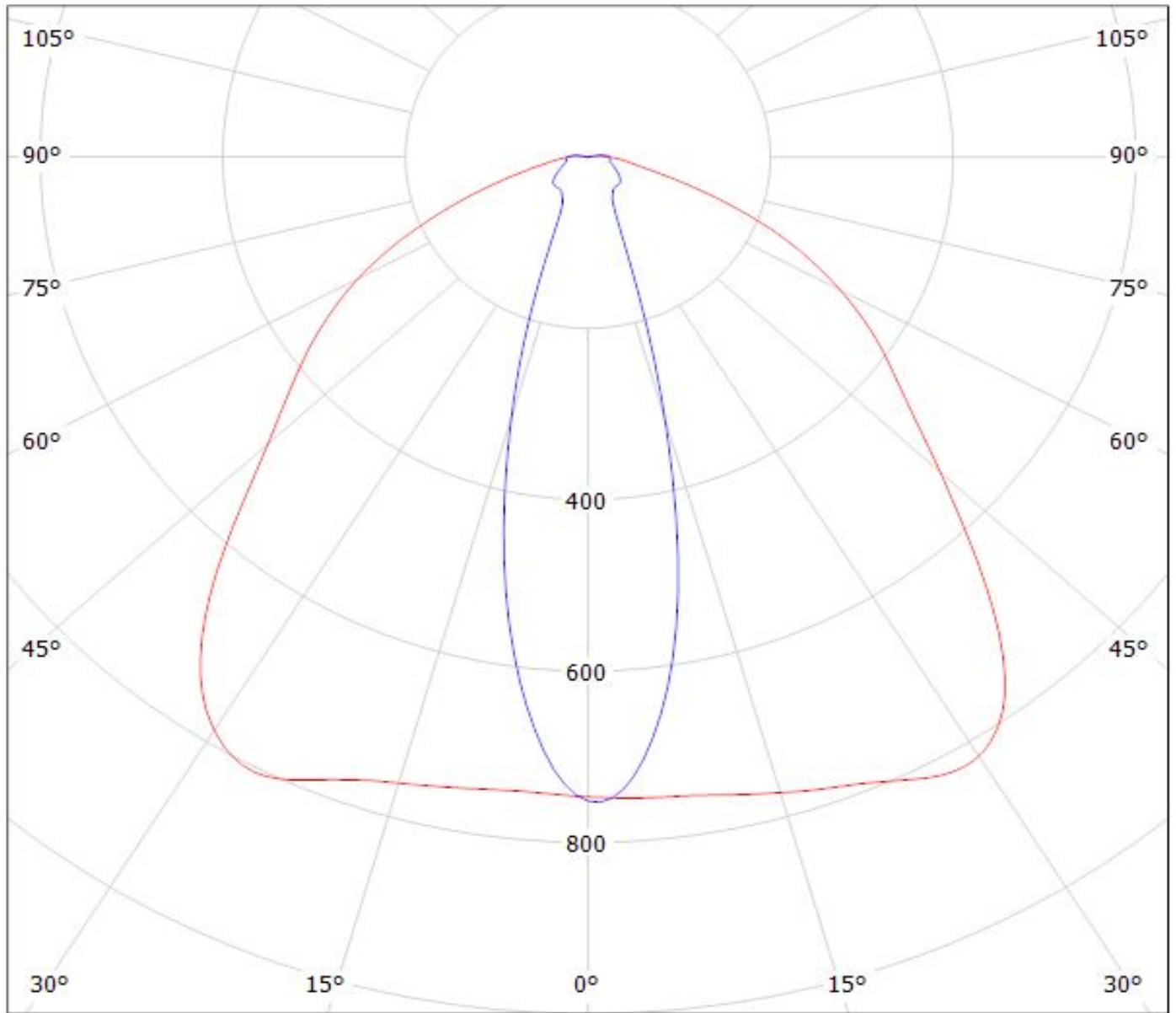

cd/klm

η = 95%

— C0 - C180    — C90 - C270



Luminaire: Ledil Oy CA13057\_FLARE-MINI-AD\_(XHP35\_HD)\_SIMULATED  
Lamps: 1 x Cree XHP35 HD

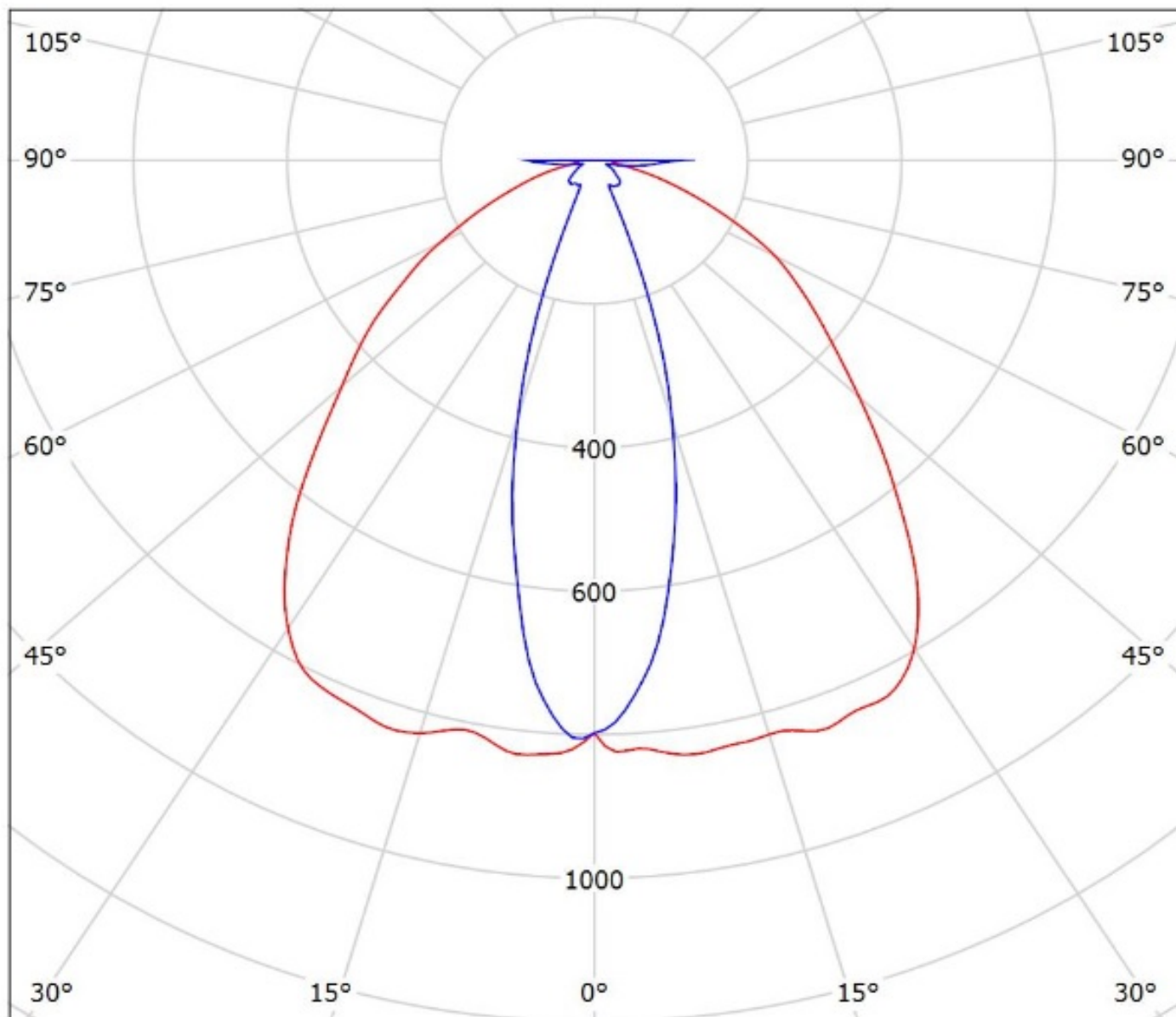

cd/klm  
— C0 - C180 — C90 - C270

$\eta = 92\%$

Luminaire: Ledil Oy CA13057\_FLARE-MINI-AD\_(XHP35\_HI)\_SIMULATED  
Lamps: 1 x Cree XHP35 HI

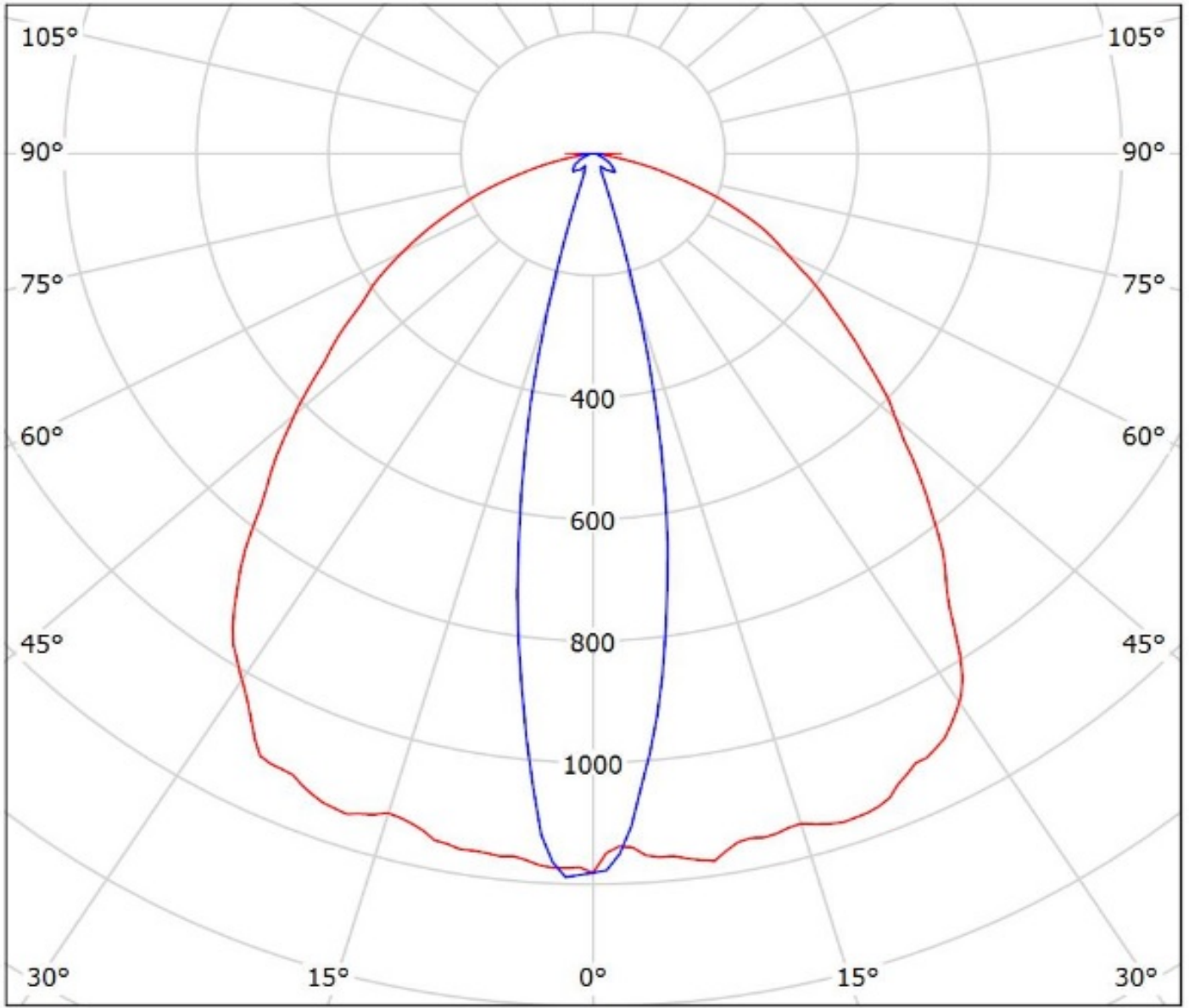

cd/klm  
— C0 - C180 — C90 - C270

$\eta = 94\%$

Luminaire: Ledil CA13057\_FLARE-MINI-AD\_(XP-L2)

Lamps: 1 x Cree\_XP-L2\_(XPLWT-00-0000-000HU630G)\_115.505lm@250mA\_P=0.72165W\_I=0.25A

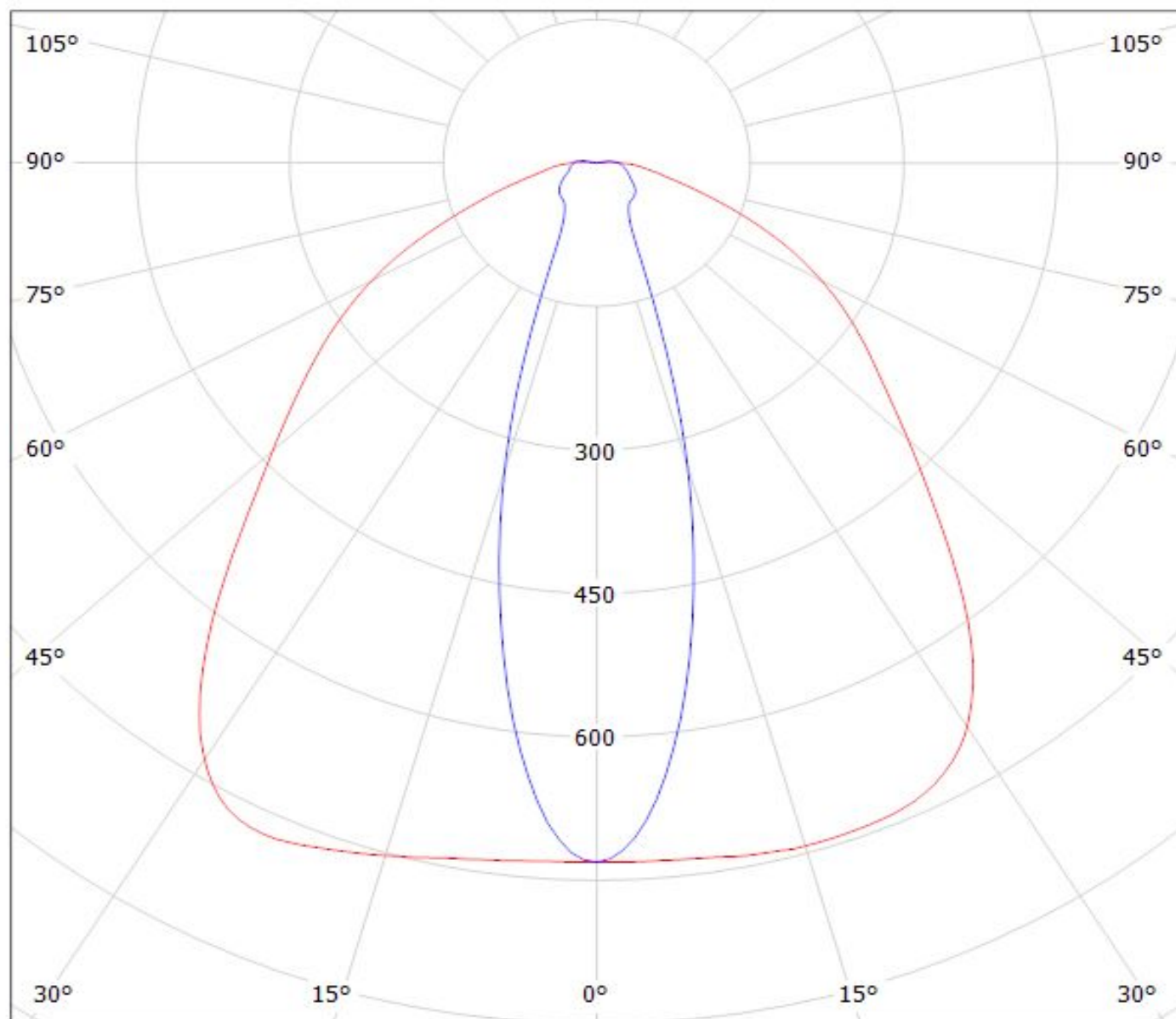

cd/klm

— C0 - C180

— C90 - C270

η = 94%

Luminaire: LEDiL Oy CA13057\_FLARE-MINI-AD\_(LG-3535-CERAMIC-GEN2) Eff.93%  
Lamps: 1 x LG-3535-CERAMIC-GEN2\_116.256lm@250mA\_P=0.754973W\_CCT=6235K\_I=249.9mA

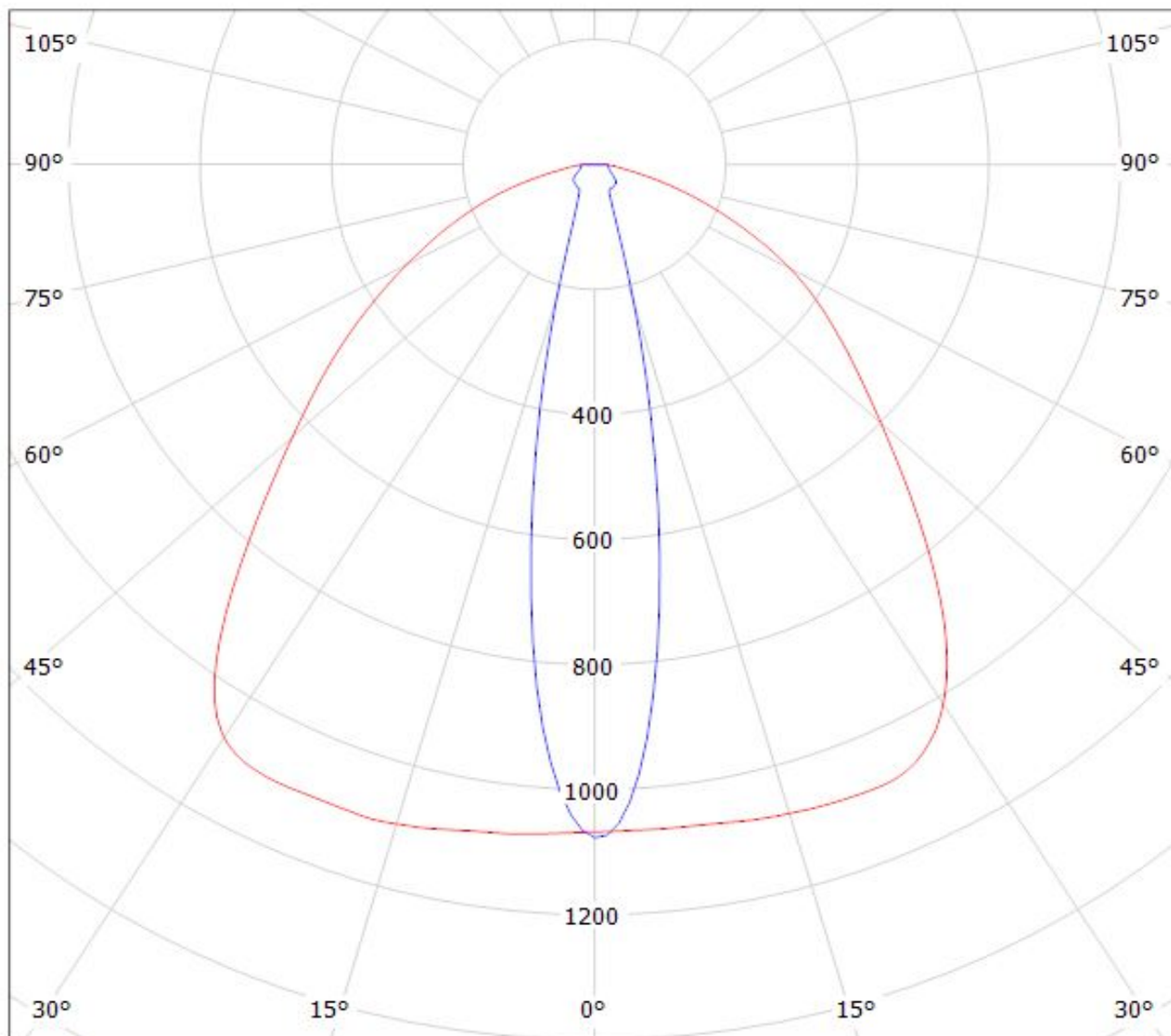

cd/klm

$\eta = 94\%$

— C0 - C180    — C90 - C270

Luminaire: Ledil Oy CA13057\_FLARE-MINI-AD\_(LH351Z) Efficiency=94%  
Lamps: 1 x Samsung LH351Z (90.14lm @ 250mA) CCT=6500K P=0.7W I=250mA

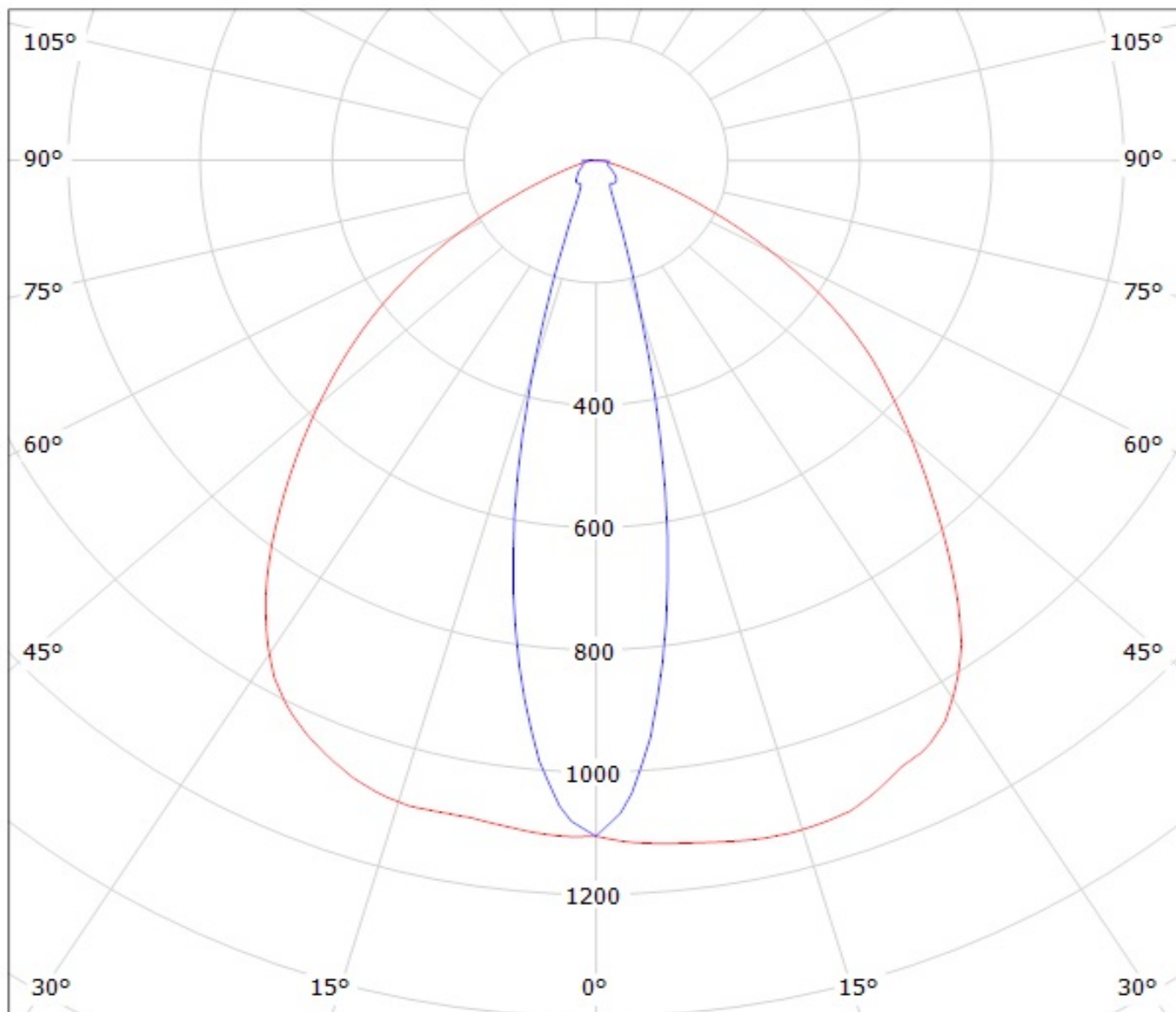

cd/klm

— C0 - C180    — C90 - C270



Luminaire: LEDil Oy CA13057\_FLARE-MINI-AD\_(Z5M1) Efficiency=94%

Lamps: 1 x Seoul Z5M1 (SZ5M1-W0-C8/W1-A5-G) 108lm @ 250mA CCT=9100K P=0.8W I=250mA

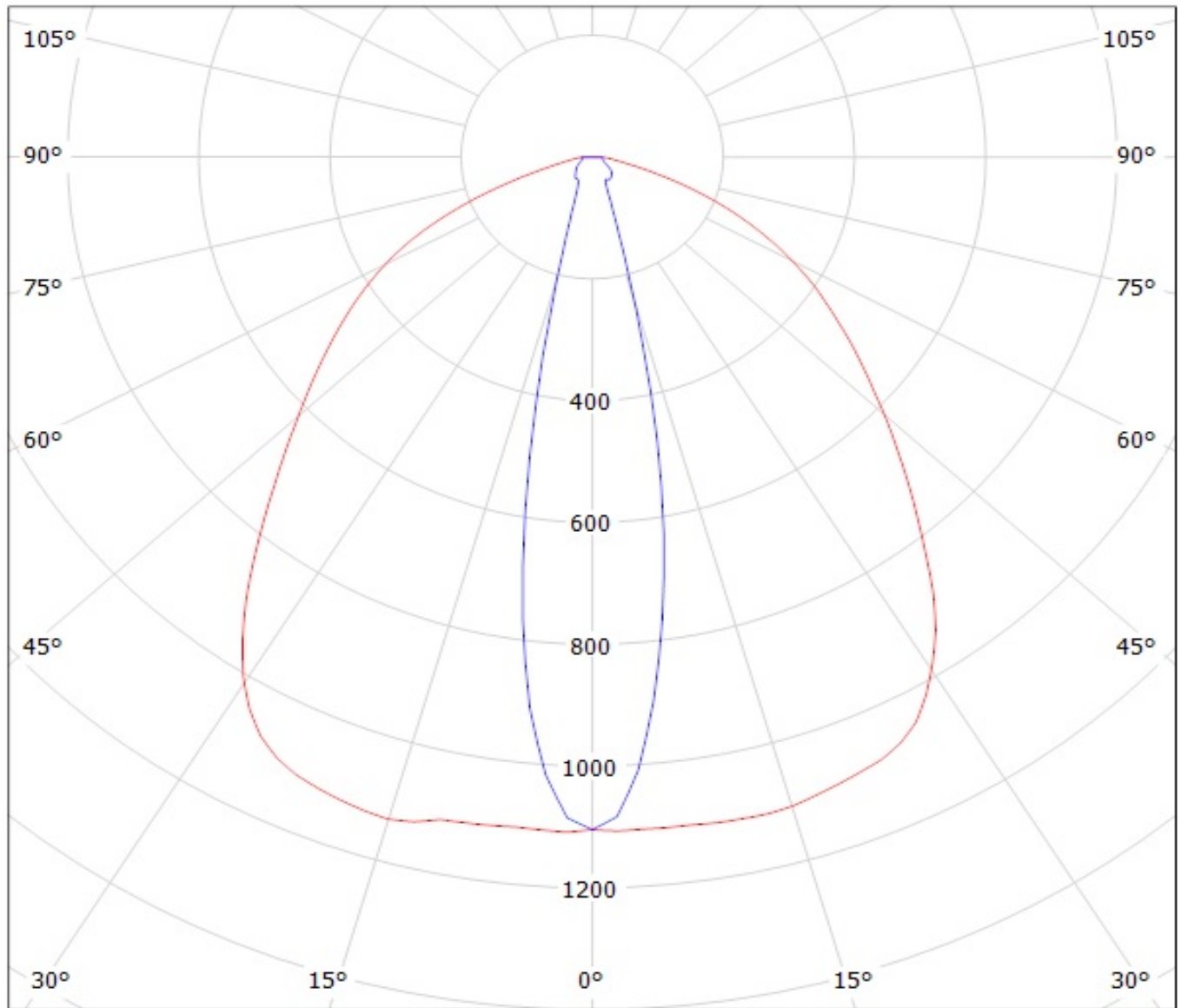

cd/klm

— C0 - C180

— C90 - C270

**NOTE: The typical divergence will be changed by different color, chip size and chip position tolerance. The typical total divergence is the full angle measured where the luminous intensity is half of the peak value.**