



# M20S-091A3A120, M20E-091A3A221

M2000 RES/EDM

**MULTIPLE LIGHT BEAM SAFETY DEVICES**

**SICK**  
Sensor Intelligence.



### Ordering information

System part	Type	Part no.
Sender	M20S-091A3A120	1016442
Receiver	M20E-091A3A221	1018036

1.) Concerns installation as a replacement part for previous type 2 device in machine: Regarding Machinery Directive 2006/42/EC, Article 1, Paragraph (2a) this type 2 device may only be used as a replacement part for identical PL d / SIL2 devices within the EU if the machine was put into circulation before 2015-05-10. Keep this note with your machine documentation. If the machine is sold on, this note and the information it contains must be passed on to every subsequent buyer. 2.) Concerns installation on new machines: Due to the amendment to the EN/IEC 61496-1 standard, this type 2 device may only be installed on new machines up to PL c / SIL1 as of 2015-05-10.

Other models and accessories → [www.sick.com/M2000\\_RES\\_EDM](http://www.sick.com/M2000_RES_EDM)



### Detailed technical data

#### Safety-related parameters

<b>Type</b>	Type 2 (IEC 61496)
<b>Safety integrity level</b>	SIL1 (IEC 61508) SILCL1 (EN 62061)
<b>Category</b>	Category 2 (EN ISO 13849)
<b>Test rate (internal test)</b>	13 /s (EN ISO 13849) <sup>1)</sup>
<b>Maximum demand rate</b>	≤ 8 min <sup>-1</sup> (EN ISO 13849) <sup>2)</sup>
<b>Performance level</b>	PL c (EN ISO 13849)
<b>PFH<sub>D</sub> (mean probability of a dangerous failure per hour)</b>	6.6 x 10 <sup>-9</sup> (EN ISO 13849)
<b>T<sub>M</sub> (mission time)</b>	20 years (EN ISO 13849)
<b>Safe state in the event of a fault</b>	At least one OSSD is in the OFF state.

<sup>1)</sup> Internal test. The test rate may not be exceeded if an external test is performed.

<sup>2)</sup> Between two requirements on a safety-related response of the device, at least 100 internal or external tests must be carried out.

#### Functions

	Functions	Delivery status
<b>Restart interlock</b>	✓	
<b>Beam coding</b>	✓	Uncoded
<b>Configurable scanning range</b>	✓	

#### Interfaces

System connection	
Connection type	Hirschmann male connector M26, 12-pin / Hirschmann plug M26, 7-pin (depending on type)
Conductor cross-section	1 mm <sup>2</sup>
Permitted cable length	≤ 60 m <sup>1)</sup>
Permitted cross-section	≥ 1 mm <sup>2</sup>

<sup>1)</sup> Depending on load, power supply and wire cross-section. The technical specifications must be observed.

<sup>2)</sup> For additional information on Flexi Soft -> [www.sick.com/Flexi\\_Soft](http://www.sick.com/Flexi_Soft).

<b>Configuration method</b>	Hard wired
<b>Display elements</b>	LEDs 7-segment display
<b>Fieldbus, industrial network</b>	
Integration via Flexi Soft safety controller	CANopen, DeviceNet™, EtherCAT®, EtherNet/IP™, Modbus TCP, PROFIBUS DP, PROFINET <sup>2)</sup>

<sup>1)</sup> Depending on load, power supply and wire cross-section. The technical specifications must be observed.

<sup>2)</sup> For additional information on Flexi Soft -> [www.sick.com/Flexi\\_Soft](http://www.sick.com/Flexi_Soft).

## Electrical data

<b>Protection class</b>	III (EN 50178)
<b>Supply voltage <math>V_s</math></b>	24 V DC (19.2 V DC ... 28.8 V DC) <sup>1)</sup>
<b>Power consumption</b>	≤ 3.7 W (DC)
<b>Safety outputs (OSSD)</b>	
Type of output	2 PNP semiconductors, short-circuit protected, cross-circuit monitored

<sup>1)</sup> The external voltage supply must be capable of buffering brief mains voltage failures of 20 ms as specified in EN 60204-1. Suitable power supplies are available as accessories from SICK.

## Mechanical data

<b>Housing cross-section</b>	48 mm x 40 mm
------------------------------	---------------

## Ambient data

<b>Enclosure rating</b>	IP65 (EN 60529)
<b>Ambient operating temperature</b>	0 °C ... +55 °C
<b>Storage temperature</b>	-25 °C ... +70 °C
<b>Air humidity</b>	15 % ... 95 %, Non-condensing
<b>Vibration resistance</b>	5 g, 10 Hz ... 55 Hz (IEC 60068-2-6)
<b>Shock resistance</b>	10 g, 16 ms (IEC 60068-2-29)

## Other information

<b>Wave length</b>	950 nm
--------------------	--------



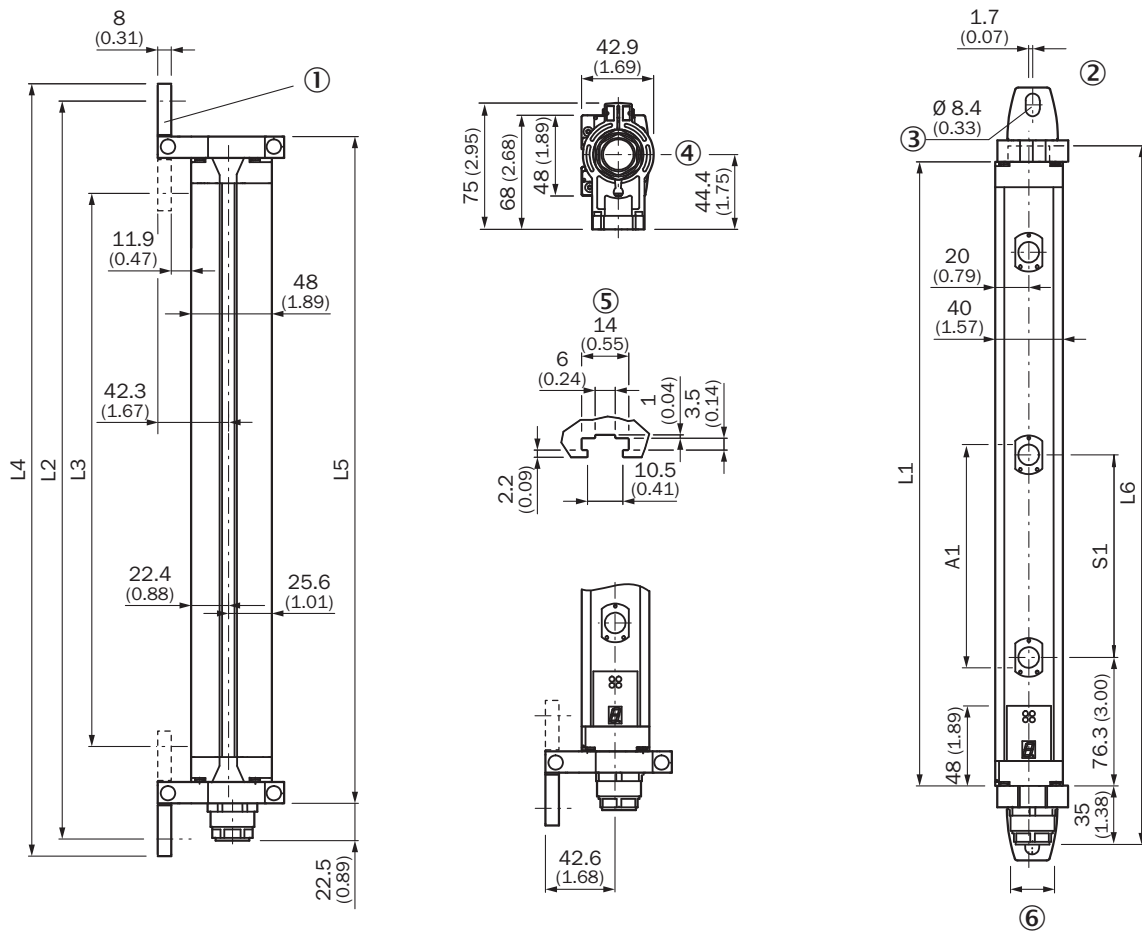



### Dimensional drawing (Dimensions in mm (inch))



Number of beams	Beam separation	Resolution	L1	L2	L3	L4	L5	L6
2	500 (19.69)	-	630 (24.80)	697 (27.44)	588 (23.15)	718 (28.27)	655 (25.79)	675 (26.57)
3	400 (15.75)	-	931 (36.65)	998 (39.29)	888 (34.96)	1,019 (40.12)	956 (37.64)	976 (38.43)
4	300 (11.81)	-	1,031 (40.59)	1,098 (43.23)	989 (38.94)	1,119 (44.06)	1,056 (41.57)	1,076 (42.36)
6	-	170 (6.69)	916 (36.06)	983 (38.70)	874 (34.41)	1,004 (39.53)	941 (37.05)	960 (37.80)
7	-	170 (6.69)	1,073 (42.24)	1,140 (44.88)	1,031 (40.59)	1,161 (45.71)	1,098 (43.23)	1,118 (44.02)
8	-	116 (4.57)	851 (33.50)	919 (36.18)	809 (31.85)	939 (36.97)	877 (34.53)	896 (35.28)
8	-	170 (6.69)	1,231 (48.46)	1,298 (51.10)	1,189 (46.81)	1,319 (51.93)	1,256 (49.45)	1,275 (50.20)
9	-	170 (6.69)	1,388 (54.65)	1,455 (57.28)	1,346 (52.99)	1,476 (58.11)	1,413 (55.63)	1,433 (56.42)

Recommended accessories

Other models and accessories → [www.sick.com/M2000\\_RES\\_EDM](http://www.sick.com/M2000_RES_EDM)

	Brief description	Type	Part no.
<b>Mounting brackets and plates</b>			
	4 pieces, Mounting kit 1, mounting bracket, rigid, L-shaped, including fixing screws and washers	BEF-3WNGBAST4	7021352
<b>Terminal and alignment brackets</b>			
	4 pieces, Mounting kit 6, side bracket, rotatable, Zinc diecast	BEF-1SHABAZN4	2019506
	4 pieces, Omega bracket, rotatable, fixable with only one screw, for mounting on the swivel mount	BEF-2SMMEAAL4	2044847
	4 pieces, Mounting kit 2, rotatable, swivel mount, Polyamide PA6	BEF-2SMMEAKU4	2019659
<b>Alignment aids</b>			
	Laser alignment aid for various sensors, laser class 2 (IEC 60825). Do not look into the beam!	AR60	1015741
	Adapter AR60 for housing cross-section 48 mm x 40 mm	AR60 adapter, 48x40	4032461
	Adapter AR60 for housing cross-section 48 mm x 40 mm in PU3H device column	AR60 adapter, 48x40, PU3H	4056731

## SICK AT A GLANCE

SICK is one of the leading manufacturers of intelligent sensors and sensor solutions for industrial applications. A unique range of products and services creates the perfect basis for controlling processes securely and efficiently, protecting individuals from accidents and preventing damage to the environment.

We have extensive experience in a wide range of industries and understand their processes and requirements. With intelligent sensors, we can deliver exactly what our customers need. In application centers in Europe, Asia and North America, system solutions are tested and optimized in accordance with customer specifications. All this makes us a reliable supplier and development partner.

Comprehensive services complete our offering: SICK LifeTime Services provide support throughout the machine life cycle and ensure safety and productivity.

For us, that is “Sensor Intelligence.”

## WORLDWIDE PRESENCE:

Contacts and other locations –[www.sick.com](http://www.sick.com)