

NICHIA CORPORATION

SPECIFICATIONS FOR FULL COLOR LED

NESM526AT

- Pb-free Reflow Soldering Application
- RoHS Compliant
- RGB Sorted (RGB die lit separately.)

SPECIFICATIONS

(1) Absolute Maximum Ratings

Item	Symbol	Absolute Maximum Rating			Unit
		Blue	Green	Red	
Forward Current	I_F	25	30	50	mA
Pulse Forward Current	I_{FP}	80	100	150	mA
Reverse Voltage	V_R	5			V
Power Dissipation	P_D	86.2	111	122	mW
Total Power Dissipation	P_{TOT}	86.2			mW
Operating Temperature	T_{opr}	-30~85			°C
Storage Temperature	T_{stg}	-40~100			°C
Junction Temperature	T_J	100	100	100	°C

* Absolute Maximum Ratings at $T_A=25^\circ\text{C}$.

* I_{FP} conditions with pulse width $\leq 10\text{ms}$ and duty cycle $\leq 10\%$.

* The absolute maximum Power Dissipation per die.

* The absolute maximum Power Dissipation in total per package.

(2) Initial Electrical/Optical Characteristics

Item	Symbol	Condition	Typ			Unit
			Blue	Green	Red	
Forward Voltage	V_F	B $I_F=20\text{mA}$ G $I_F=20\text{mA}$ R $I_F=20\text{mA}$	3.1	3.4	2.15	V
Reverse Current	I_R	B $V_R=5\text{V}$ G $V_R=5\text{V}$ R $V_R=5\text{V}$	-	-	-	μA
Luminous Intensity	I_v	B $I_F=20\text{mA}$ G $I_F=20\text{mA}$ R $I_F=20\text{mA}$	150	700	465	mcd
Chromaticity Coordinate	x	B $I_F=20\text{mA}$ G $I_F=20\text{mA}$ R $I_F=20\text{mA}$	0.133	0.189	0.696	-
	y		0.075	0.718	0.303	

* Characteristics at $T_A=25^\circ\text{C}$.

* Luminous Intensity value as per CIE 127:2007 standard.

* Chromaticity Coordinates as per CIE 1931 Chromaticity Chart.

RANKS

Item	Blue			Green			Red			Unit
	Rank	Min	Max	Rank	Min	Max	Rank	Min	Max	
Forward Voltage	-	2.80	3.45	-	2.90	3.70	-	1.70	2.45	V
Reverse Current	-	-	50	-	-	50	-	-	50	μA
Luminous Intensity	BT	159	200	GT	715	900	RT	476	600	mcd
	BS	126	159	GS	565	715	RS	378	476	
	BR	100	126	GR	450	565	RR	300	378	

Color Ranks

Blue

	Rank W1			
x	0.139	0.129	0.145	0.152
y	0.035	0.050	0.072	0.056

	Rank W2			
x	0.129	0.113	0.134	0.145
y	0.050	0.080	0.105	0.072

Green

	Rank G1m			
x	0.166	0.136	0.176	0.201
y	0.676	0.739	0.750	0.686

	Rank G2m			
x	0.201	0.176	0.220	0.237
y	0.686	0.750	0.745	0.684

Red

	Rank R8a			
x	0.6718	0.6562	0.6873	0.7049
y	0.2982	0.3144	0.3126	0.2948

* Ranking at T_A=25°C.

* Forward Voltage Tolerance: ±0.05V

* Luminous Intensity Tolerance: ±10%

* Chromaticity Coordinate Tolerance: ±0.01

* LEDs from the above ranks will be shipped.

The rank combination ratio per shipment will be decided by Nichia.

Luminous Intensity Ranks by Color Rank

Ranking by Color Coordinates	Ranking by Luminous Intensity								
	BR	BS	BT	GR	GS	GT	RR	RS	RT
W1									
W2									
G1m,G2m									
R8a									

CHROMATICITY DIAGRAM

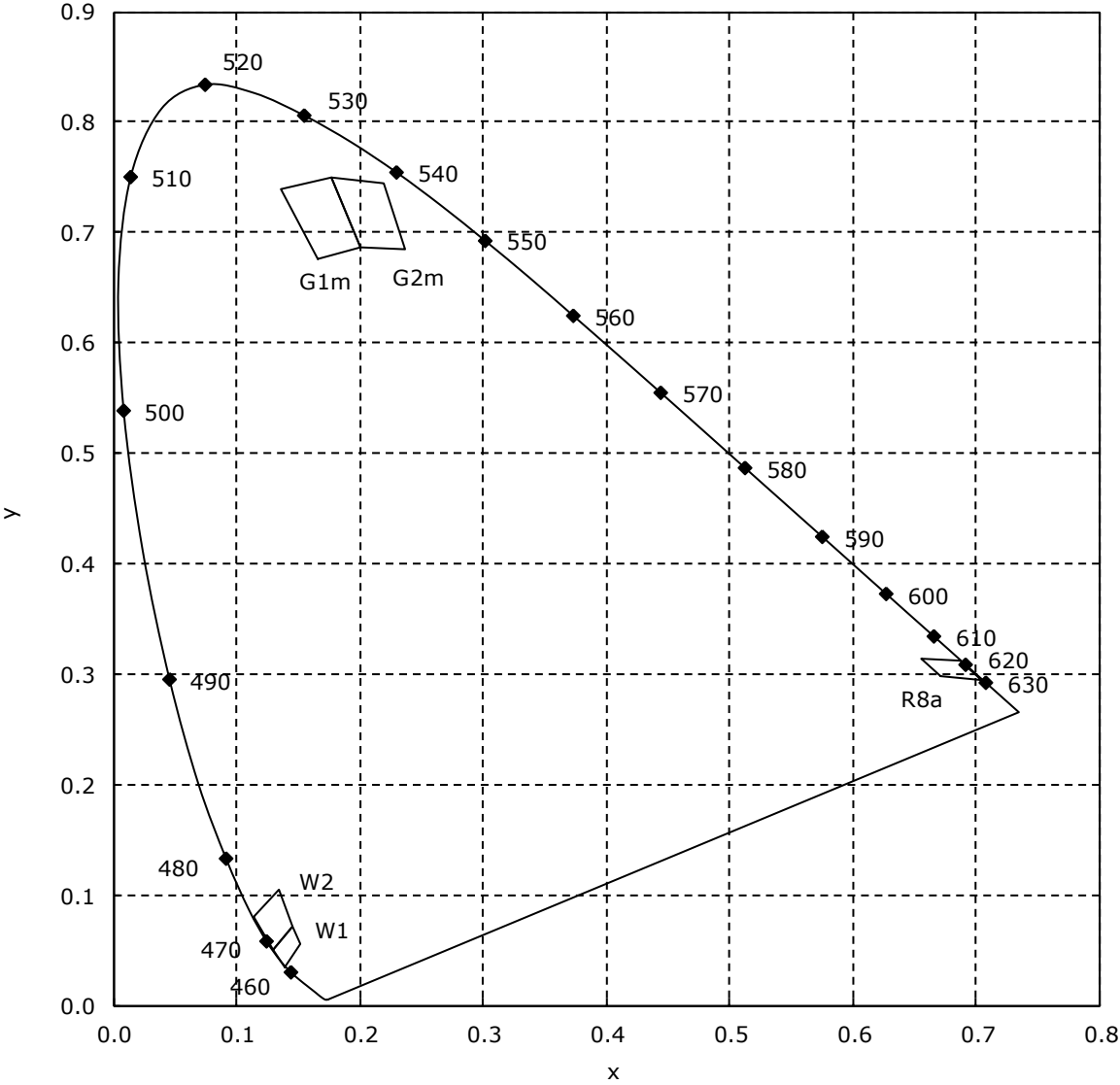

OUTLINE DIMENSIONS

* 本製品はRoHS指令に適合しております。
This product complies with RoHS Directive.

NESM526A
管理番号 No. STS-DA7-10575

* 括弧で囲まれた寸法は参考値です。
The dimension(s) in parentheses are for reference purposes.

(単位 Unit: mm, 公差 Tolerance: ±0.2)

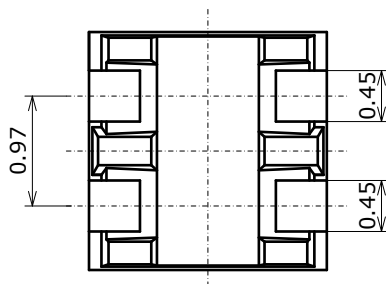
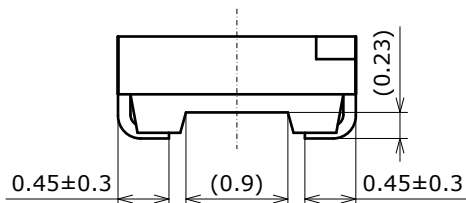
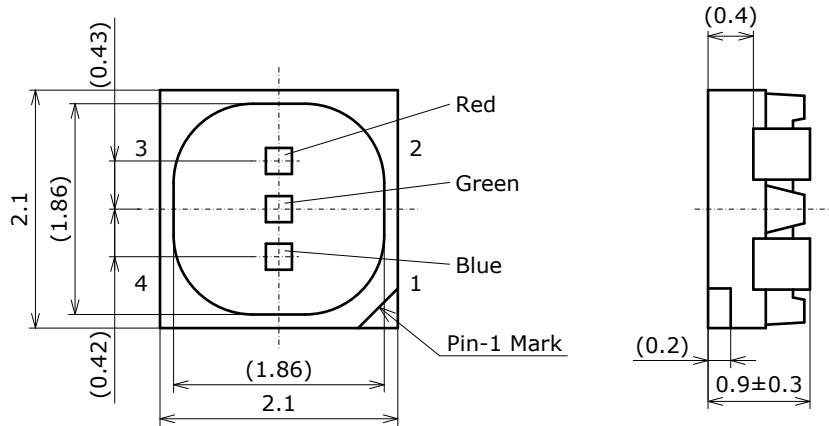

項目 Item	内容 Description
パッケージ材質 Package Materials	耐熱性ポリマー Heat-Resistant Polymer
封止樹脂材質 Encapsulating Resin Materials	エポキシ樹脂(拡散剤入り) Epoxy Resin(with diffuser)
電極材質 Electrodes Materials	銅合金+金メッキ Au-plated Copper Alloy
質量 Weight	0.0072g(TYP)

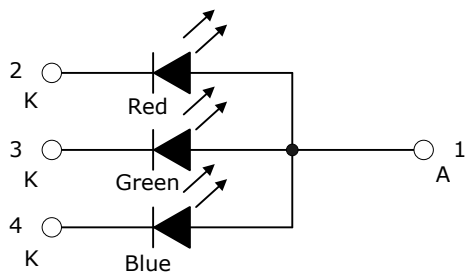

* Redダイ、Blueダイ、Greenダイは アノード側に実装されています。
The Red, Blue and Green die are attached to the Anode side.

SOLDERING

• Recommended Reflow Soldering Condition(Lead-free Solder)

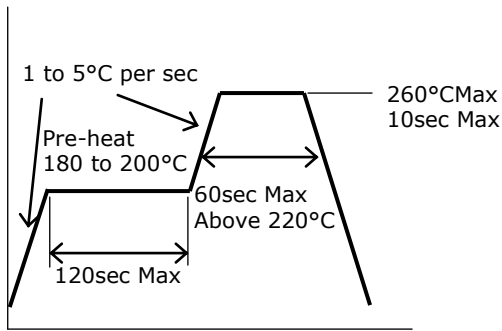

• Recommended Hand Soldering Condition

Temperature	350°C Max
Soldering Time	3sec Max

• Recommended Soldering Pad Pattern

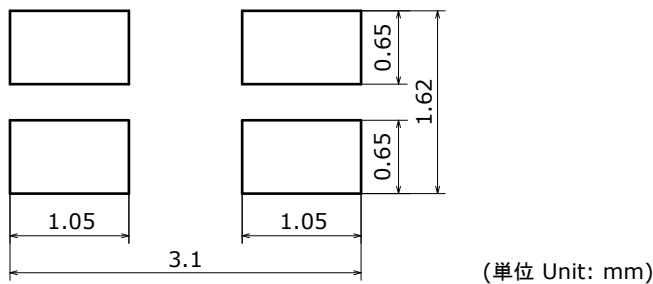

- * This LED is designed to be reflow soldered on to a PCB. If dip soldered, Nichia cannot guarantee its reliability.
- * Reflow soldering must not be performed more than twice. Hand soldering must not be performed more than once.
- * If the LEDs are reflowed a second time, it is recommended to perform the second soldering as soon as the LEDs have cooled down to room temperature naturally after the first soldering in order to avoid moisture absorption.
- * Avoid rapid cooling. Ramp down the temperature gradually from the peak temperature.
- * Nitrogen reflow soldering is recommended. Air flow soldering conditions can cause optical degradation, caused by heat and/or atmosphere.
- * Repairing should not be done after the LEDs have been soldered. When repairing is unavoidable, a double-head soldering iron should be used.
It should be confirmed beforehand whether the characteristics of the LEDs will or will not be damaged by repairing.
- * When soldering, do not apply stress to the LED while the LED is hot.
- * When using a pick and place machine, choose an appropriate nozzle for this product.
- * This product can differ in optical characteristics depending on both the number of reflow cycles and reflow temperature conditions. In a single display, only LEDs with both the same number of reflow cycles and reflow temperature conditions should be used regardless of the application type (e.g. rental and/or permanent installations).
- * The recommended soldering pad pattern is designed for attachment of the LED without problems.
When precise mounting accuracy is required, such as high-density mounting, ensure that the size and shape of the pad are suitable for the circuit design.
- * Consider factors such as the reflow soldering temperature, hand soldering temperature, etc. when choosing the solder.
- * When flux is used, it should be a halogen free flux. Ensure that the manufacturing process is not designed in a manner where the flux will come in contact with the LEDs.
- * Make sure that there are no issues with the type and amount of solder that is being used.

TAPE AND REEL DIMENSIONS

テーピング部 Tape

Nxxx526x
管理番号 No. STS-DA7-10576
(単位 Unit: mm)

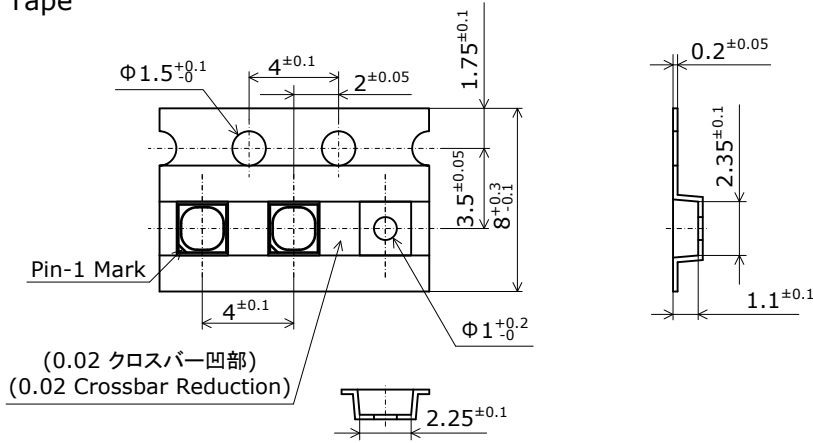

トレーラ部/リーダ部 Trailer and Leader

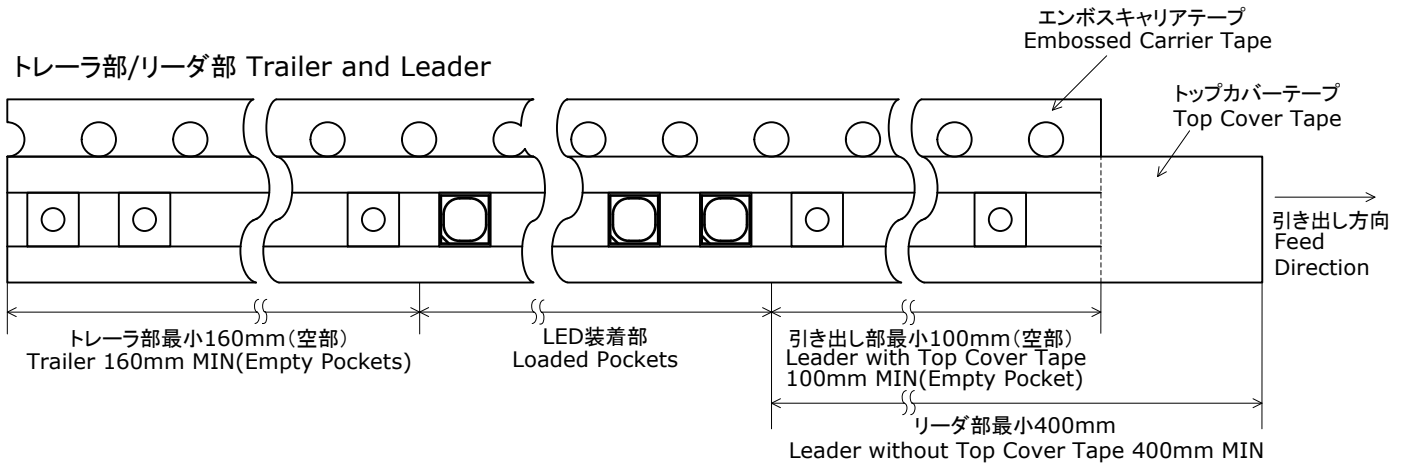

リール部 Reel

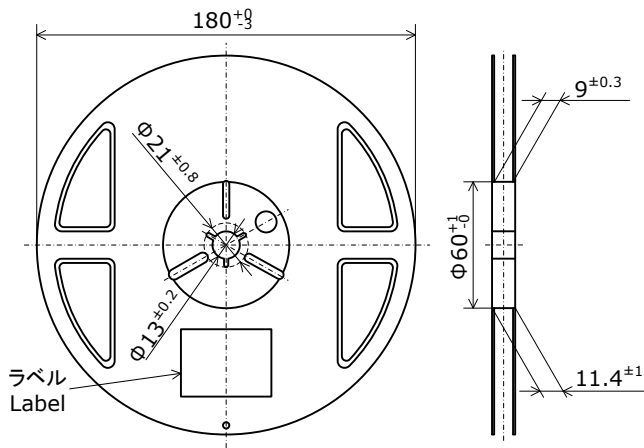

- * 数量は1リールにつき 4000個入りです。
Reel Size: 4000pcs
- * 実装作業の中断などでエンボスキャリアテープをリールに巻き取る場合、エンボスキャリアテープを強く(10N以上)締めないで下さい。
LEDがカバーテープに貼り付く可能性があります。
When the tape is rewound due to work interruptions, no more than 10N should be applied to the embossed carrier tape.
The LEDs may stick to the top cover tape.
- * JIS C 0806電子部品テーピングに準拠しています。
The tape packing method complies with JIS C 0806 (Packaging of Electronic Components on Continuous Tapes).

PACKAGING - TAPE & REEL

シリカゲルとともにリールをアルミ防湿袋に入れ、熱シールにより封をします。
Reels are shipped with desiccants in heat-sealed moisture-proof bags.

Nxxxxxxx
管理番号 No. STS-DA7-0006C

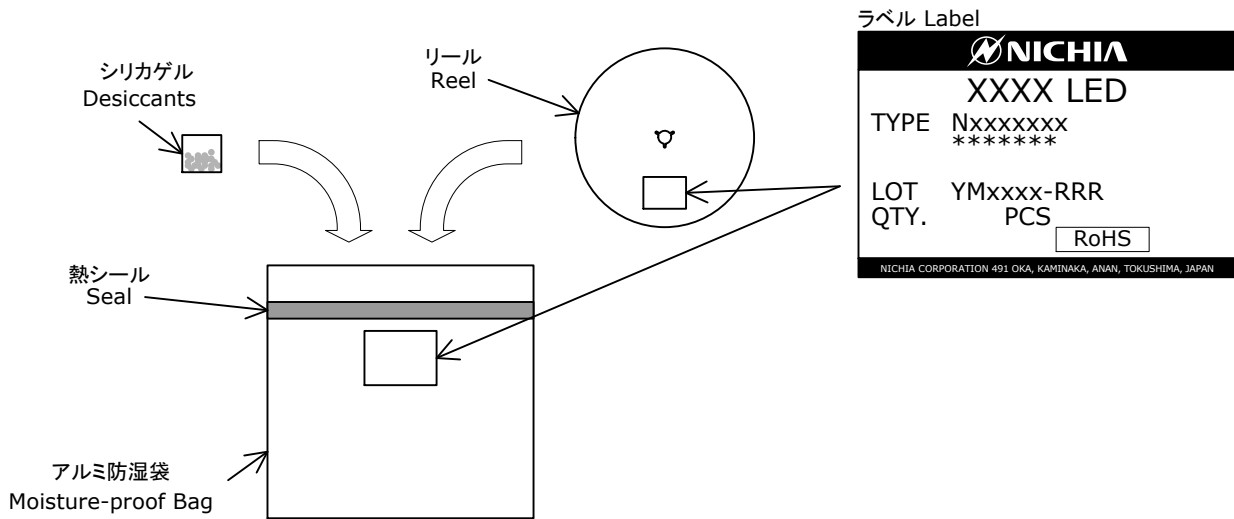

アルミ防湿袋を並べて入れ、ダンボールで仕切ります。
Moisture-proof bags are packed in cardboard boxes with corrugated partitions.

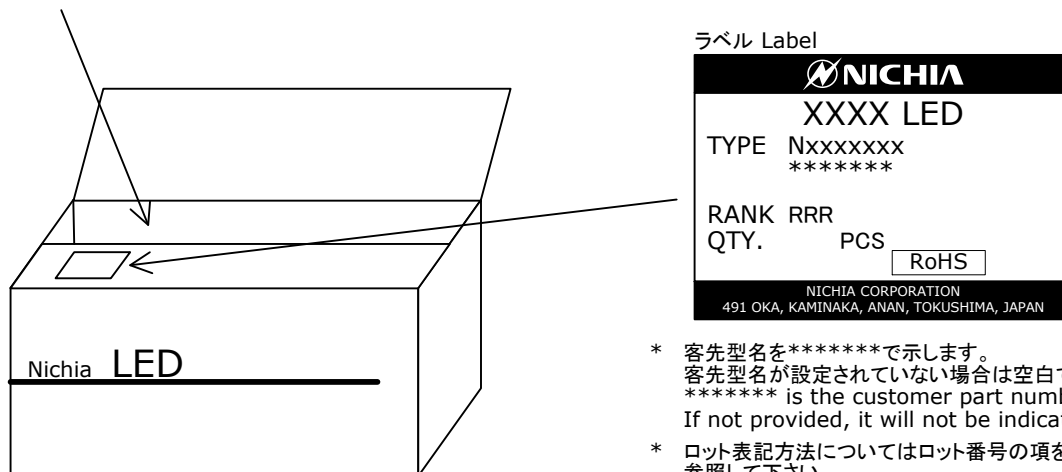

- * 客先型名を*****で示します。
客先型名が設定されていない場合は空白です。
***** is the customer part number.
If not provided, it will not be indicated on the label.
- * ロット表記方法についてはロット番号の項を参照して下さい。
For details, see "LOT NUMBERING CODE" in this document.
- * ランク分けがない場合はランク表記はありません。
The label does not have the RANK field for un-ranked products.

- * 本製品はテーピングしたのち、輸送の衝撃から保護するためダンボールで梱包します。
Products shipped on tape and reel are packed in a moisture-proof bag.
They are shipped in cardboard boxes to protect them from external forces during transportation.
- * 取り扱いに際して、落下させたり、強い衝撃を与えたりしますと、製品を損傷させる原因になりますので注意して下さい。
Do not drop or expose the box to external forces as it may damage the products.
- * ダンボールには防水加工がされておりませんので、梱装箱が水に濡れないよう注意して下さい。
Do not expose to water. The box is not water-resistant.
- * 輸送、運搬に際して弊社よりの梱包状態あるいは同等の梱包を行って下さい。
Using the original package material or equivalent in transit is recommended.

LOT NUMBERING CODE

Lot Number is presented by using the following alphanumeric code.

YMxxxx - RRR

Y - Year

Year	Y
2015	F
2016	G
2017	H
2018	I
2019	J
2020	K

M - Month

Month	M	Month	M
1	1	7	7
2	2	8	8
3	3	9	9
4	4	10	A
5	5	11	B
6	6	12	C

xxxx-Nichia's Product Number

RRR-Rank

* The label does not have the RANK field for un-ranked products.

DERATING CHARACTERISTICS

NESM526A
管理番号 No. STS-DA7-10577

周囲温度-許容損失特性 *

Ambient Temperature vs Power Dissipation

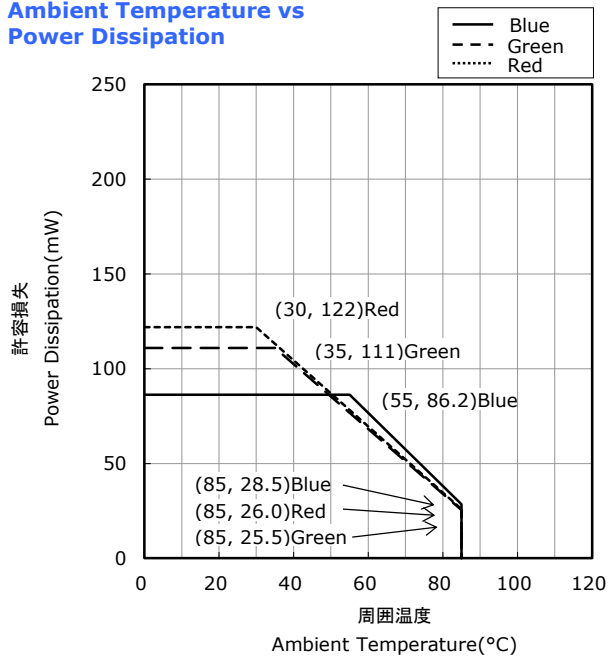

周囲温度-全許容損失特性 **

Ambient Temperature vs Total Power Dissipation

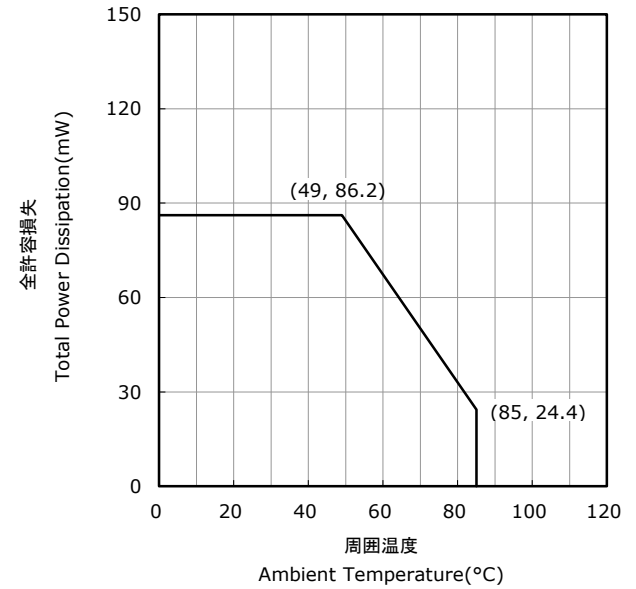

デューティー比-許容順電流特性

Duty Ratio vs Allowable Forward Current

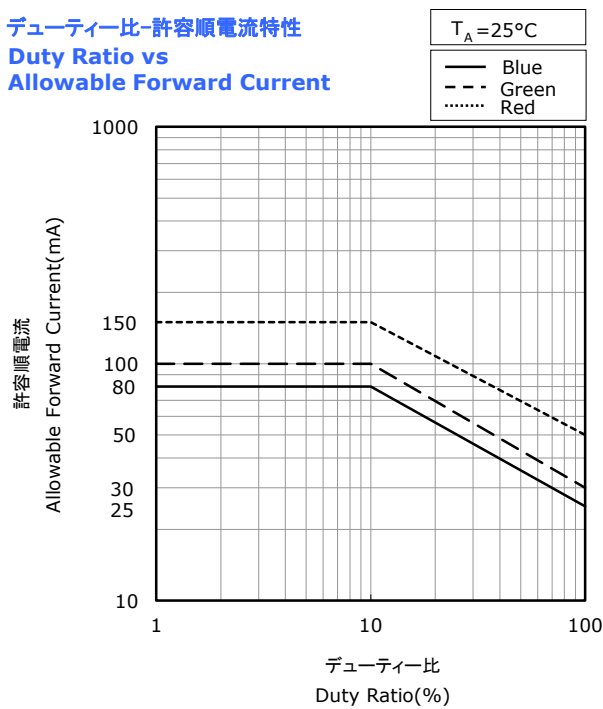

* 多色点灯の際も、1素子当たりの値はこの定格内におさめて下さい。
The graph shows the maximum allowable power dissipation for a LED die of each color.

** 2素子以上点灯の際は、トータル値を定格内におさめて下さい。
The graph shows the maximum allowable total power dissipation for a LED package.

OPTICAL CHARACTERISTICS

* 本特性は参考です。
All characteristics shown are for reference only and are not guaranteed.

NESM526A
管理番号 No. STS-DA7-10578

発光スペクトル Spectrum

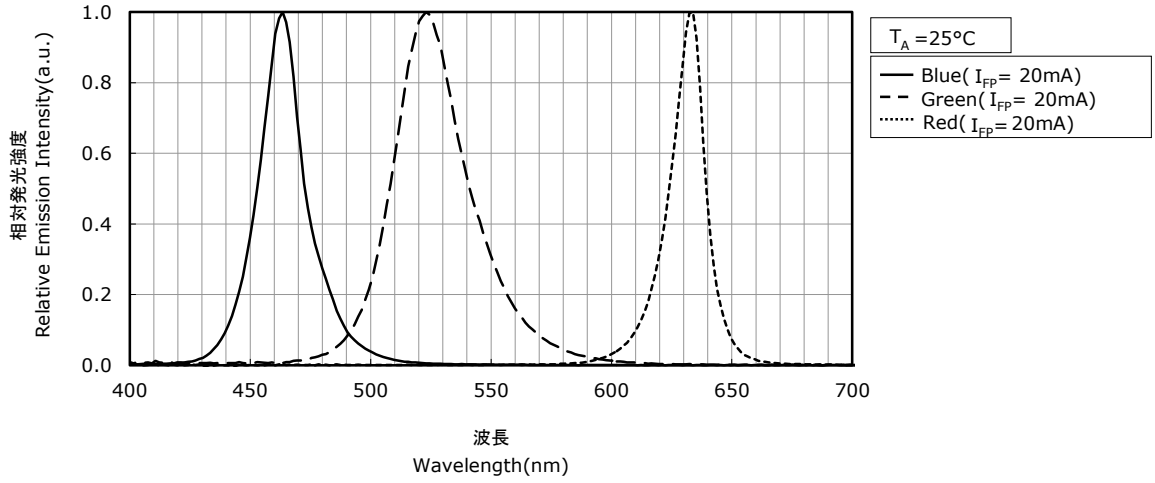

指向特性 Directivity

X-X



Y-Y

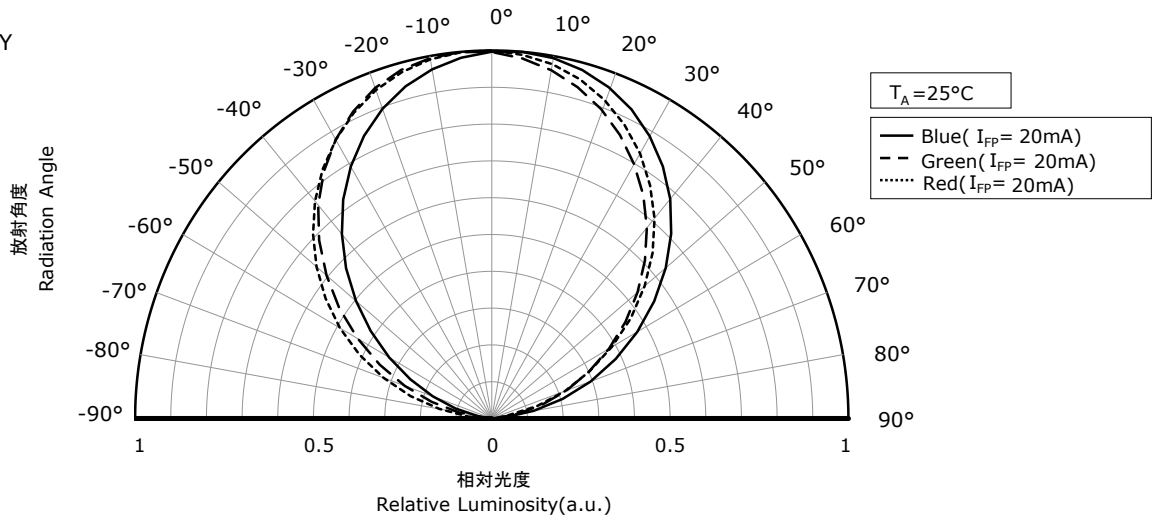

FORWARD CURRENT CHARACTERISTICS / TEMPERATURE CHARACTERISTICS

* 本特性は参考です。
All characteristics shown are for reference only and are not guaranteed.

NESM526A
管理番号 No. STS-DA7-10579

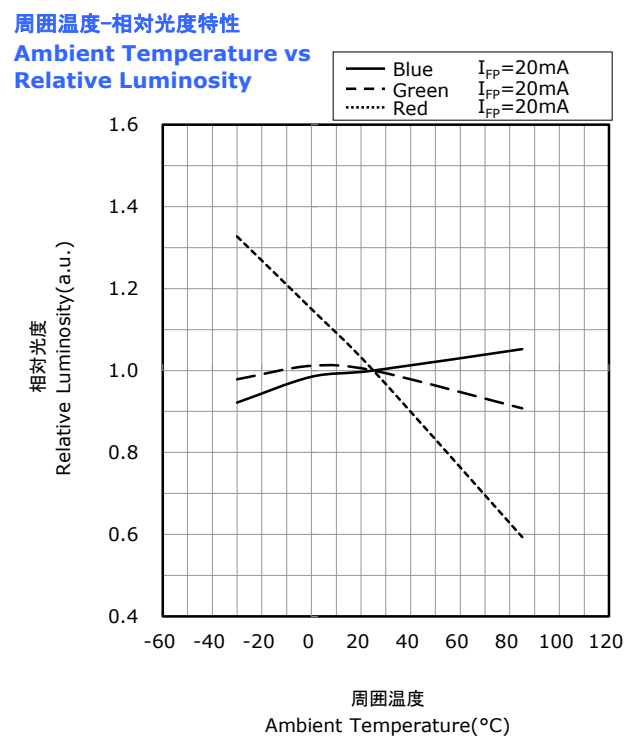
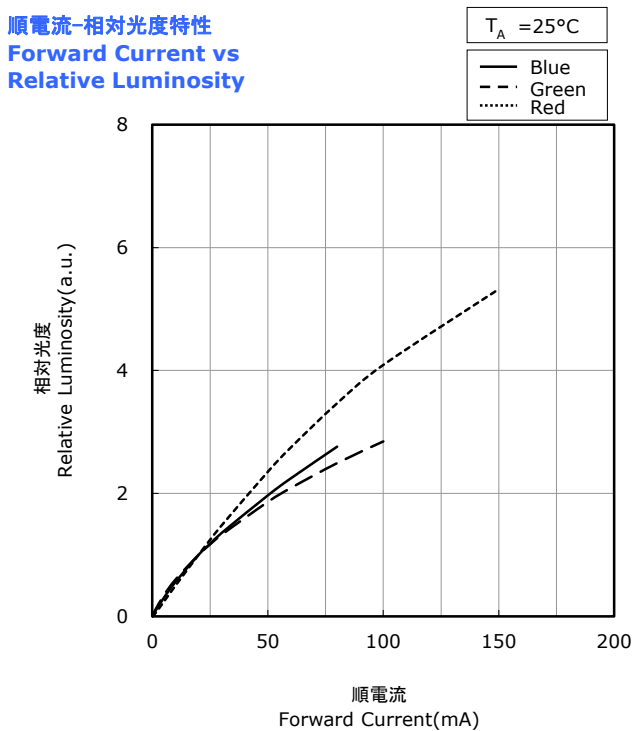
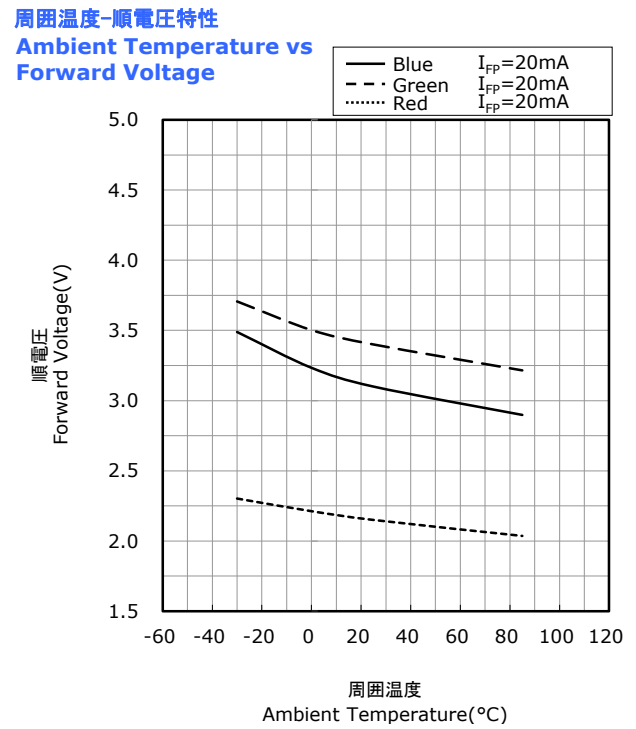
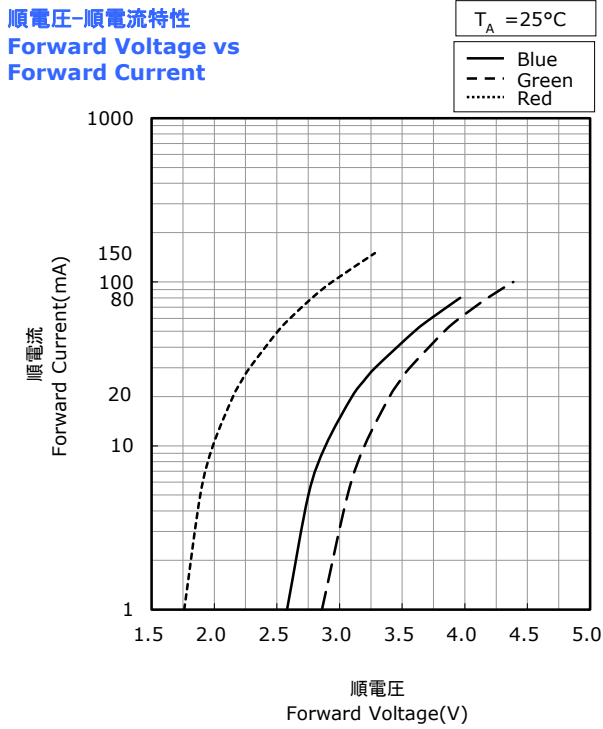

RELIABILITY

(1) Tests and Results

Test	Reference Standard	Test Conditions		Test Duration	Failure Criteria #	Units Failed/Tested
Resistance to Soldering Heat (Reflow Soldering)	JEITA ED-4701 300 301	T _{slid} =260°C, 10sec, 2reflows, Precondition: 30°C, 70%RH, 168hr			#1	0/22
Temperature Cycle	JEITA ED-4701 100 105	-40°C(30min)~25°C(5min)~ 100°C(30min)~25°C(5min)		100cycles	#1	0/22
Moisture Resistance (Cyclic)	JEITA ED-4701 200 203	25°C~65°C~-10°C, 90%RH, 24hr per cycle		10cycles	#1	0/22
High Temperature Storage	JEITA ED-4701 200 201	T _A =100°C		500hours	#1	0/22
Temperature Humidity Storage	JEITA ED-4701 100 103	T _A =60°C, RH=90%		500hours	#1	0/22
Low Temperature Storage	JEITA ED-4701 200 202	T _A =-40°C		500hours	#1	0/22
Room Temperature Operating Life		T _A =25°C	B I _F =7mA G I _F =9mA R I _F =9mA	500hours	#1	0/22
Temperature Humidity Operating Life		60°C, RH=90%	B I _F =3mA G I _F =5mA R I _F =5mA	300hours	#1	0/22
Low Temperature Operating Life		T _A =-30°C	B I _F =7mA G I _F =9mA R I _F =9mA	500hours	#1	0/22

NOTES:

Measurements are performed after allowing the LEDs to return to room temperature.

(2) Failure Criteria (Value for one LED device (Single color).)

Criteria #	Items	Conditions	Failure Criteria
#1	Forward Voltage(V _F)	B I _F =20mA G I _F =20mA R I _F =20mA	>U.S.L. × 1.1
	Luminous Intensity(I _V)	B I _F =20mA G I _F =20mA R I _F =20mA	<L.S.L. × 0.7
	Reverse Current(I _R)	B V _R =5V G V _R =5V R V _R =5V	>U.S.L. × 2.0

U.S.L. : Upper Specification Limit L.S.L. : Lower Specification Limit

CAUTIONS

(1) Storage

Conditions		Temperature	Humidity	Time
Storage	Before Opening Aluminum Bag	≤30°C	≤90%RH	Within 1 Year from Delivery Date
	After Opening Aluminum Bag	≤30°C	≤70%RH	≤168hours
Baking		65±5°C	-	≥24hours

- Product complies with JEDEC MSL 3 or equivalent. See IPC/JEDEC STD-020 for moisture-sensitivity details.
- Absorbed moisture in LED packages can vaporize and expand during soldering, which can cause interface delamination and result in optical performance degradation. Products are packed in moisture-proof aluminum bags to minimize moisture absorption during transportation and storage.
Included silica gel desiccants change from blue to red if moisture had penetrated bags.
- After opening the moisture-proof aluminum bag, the products should go through the soldering process within the range of the conditions stated above. Unused remaining LEDs should be stored with silica gel desiccants in a hermetically sealed container, preferably the original moisture-proof bags for storage.
- After the "Period After Opening" storage time has been exceeded or silica gel desiccants are no longer blue, the products should be baked. Baking should only be done once.
- Although the leads or electrode pads (anode and cathode) of the product are plated with gold, prolonged exposure to a corrosive environment might cause the gold plated the leads or electrode pads to tarnish, and thus leading to difficulties in soldering. If unused LEDs remain, they must be stored in a hermetically sealed container. Nichia recommends using the original moisture-proof bag for storage.
- Do not use sulfur-containing materials in commercial products. Some materials, such as seals and adhesives, may contain sulfur. The contaminated plating of LEDs might cause an open circuit. Silicone rubber is recommended as a material for seals. Bear in mind, the use of silicones may lead to silicone contamination of electrical contacts inside the products, caused by low molecular weight volatile siloxane.
- To prevent water condensation, please avoid large temperature and humidity fluctuations for the storage conditions.
- Do not store the LEDs in a dusty environment.
- Do not expose the LEDs to direct sunlight and/or an environment where the temperature is higher than normal room temperature.

(2) Directions for Use

- In designing a circuit, the current through each LED die must not exceed the Absolute Maximum Rating current specified for each die.
It is recommended that each LED die is driven at a constant current.
- When having the two or more dice within this product on at the same time, the total power dissipation for the LED package must be within the absolute maximum value specified in this specification.
- This product should be operated using forward current. Ensure that the product is not subjected to either forward or reverse voltage while it is not in use. In particular, subjecting it to continuous reverse voltage may cause migration, which may cause damage to the LED die. When used in displays that are not used for a long time, the main power supply should be switched off for safety.
- It is recommended to operate the LEDs at a current greater than 10% of the sorting current to stabilize the LED characteristics.
- Care must be taken to ensure that the reverse voltage will not exceed the Absolute Maximum Rating when using the LEDs with matrix drive.
- Ensure that excessive voltages such as lightning surges are not applied to the LEDs.
- Aging is recommended for detecting manufacturing and assembly defects. In particular, ensure that excessive current and/or voltage is not applied to the LEDs. This aging should be conducted in environments where water condensation does not occur.
- This product can be used in indoor applications; however, when the LEDs are used in the following environments, incorporate sufficient measures into the display to prevent debris, water/moisture and gases that will adversely affect the product.
 - where water vapor is abundant
 - where water condensation is likely to occur
 - where water is likely to splash onto the LEDs
 - where frost is likely to form on the surface of the LEDs (e.g. freezer, ice skating rink, etc.)
 - where dust, dirt, debris, loose metallic materials and/or gases that will adversely affect the product are present
- In areas where hydrogen sulfide, which is a sulfide-based gas, is present (e.g. hot springs and volcanic areas), and where salt is abundant (e.g. coastal areas), the life may be shortened.
- When this product is used for displays that will be installed outside: the LEDs should be covered to avoid exposure to outdoor environments in conjunction with sufficient measures against direct sunlight, wet or damp conditions, and salt damage.
- When power is applied for the first time after installation, the display should not be powered at 100% wattage since the LEDs may have absorbed moisture. Before normal use of this display, operate the display at approximately 20% wattage for an initial time period.
- If the display units will be rented, those units should be selected carefully to ensure that the display as a whole will appear the same color and brightness.
- If the display units are loaded onto and/or transported by ship, the damp environment on the vessel will cause condensation; the display units should be packaged to prevent moisture absorption.
- If a display that has been, or is being, used is relocated, it is possible that degradation of the LED has occurred. When transporting this display, provide sufficient protection for the LEDs in addition to the moisture-proof packaging for the display. When this display is reinstalled, ensure to follow the installation instructions for environments and use.
- If a secondary lens is used to collimate or diffuse the light, sufficient verification should be performed to ensure that there are no issues (e.g. color variation) prior to use.

(3) Handling Precautions

- Do not handle the LEDs with bare hands as it will contaminate the LED surface and may affect the optical characteristics: it might cause the LED to be deformed and/or the wire to break, which will cause the LED not to illuminate.
The lead could also cause an injury.
- When handling the product with tweezers, be careful not to apply excessive force to the resin.
Otherwise, The resin can be cut, chipped, delaminate or deformed, causing wire-bond breaks and catastrophic failures.
- Dropping the product may cause damage.
- Do not stack assembled PCBs together. Failure to comply can cause the resin portion of the product to be cut, chipped, delaminated and/or deformed. It may cause wire to break, leading to catastrophic failures.

(4) Design Consideration

- PCB warpage after mounting the products onto a PCB can cause the package to break.
The LED should be placed in a way to minimize the stress on the LEDs due to PCB bow and twist.
- The position and orientation of the LEDs affect how much mechanical stress is exerted on the LEDs placed near the score lines.
The LED should be placed in a way to minimize the stress on the LEDs due to board flexing.
- Board separation must be performed using special jigs, not using hands.

(5) Electrostatic Discharge (ESD)

- The products are sensitive to static electricity or surge voltage. ESD can damage a die and its reliability.
When handling the products, the following measures against electrostatic discharge are strongly recommended:
 - Eliminating the charge
 - Grounded wrist strap, ESD footwear, clothes, and floors
 - Grounded workstation equipment and tools
 - ESD table/shelf mat made of conductive materials
- Ensure that tools (e.g. soldering irons), jigs and machines that are being used are properly grounded and that proper grounding techniques are used in work areas. For devices/equipment that mount the LEDs, protection against surge voltages should also be used.
- If tools or equipment contain insulating materials such as glass or plastic, the following measures against electrostatic discharge are strongly recommended:
 - Dissipating static charge with conductive materials
 - Preventing charge generation with moisture
 - Neutralizing the charge with ionizers
- The customer is advised to check if the LEDs are damaged by ESD when performing the characteristics inspection of the LEDs in the application.
Damage can be detected with a forward voltage measurement or a light-up test at low current ($\leq 1\text{mA}$).
- LEDs with ESD-damaged dice (i.e. other than red) may have an increased leakage current, current flow at a low voltage, or no longer illuminate at a low current.
Failure Criteria: $V_F < 2.0\text{V}$ at $I_F = 0.5\text{mA}$

(6) Thermal Management

- Proper thermal management is an important when designing products with LEDs. LED die temperature is affected by PCB thermal resistance and LED spacing on the board. Please design products in a way that the LED die temperature does not exceed the maximum Junction Temperature (T_J).
- Drive current should be determined for the surrounding ambient temperature (T_A) to dissipate the heat from the product.

(7) Cleaning

- The LEDs should not be cleaned with water, benzine, and/or thinner.
- If required, isopropyl alcohol (IPA) should be used. Other solvents may cause premature failure to the LEDs due to the damage to the resin portion. The effects of such solvents should be verified prior to use.
In addition, the use of CFCs such as Freon is heavily regulated.
- When dust and/or dirt adheres to the LEDs, soak a cloth with Isopropyl alcohol (IPA), then squeeze it before wiping the LEDs.
- Ultrasonic cleaning is not recommended since it may have adverse effects on the LEDs depending on the ultrasonic power and how LED is assembled.
If ultrasonic cleaning must be used, the customer is advised to make sure the LEDs will not be damaged prior to cleaning.

(8) Eye Safety

- In 2006, the International Electrical Commission (IEC) published IEC 62471:2006 Photobiological safety of lamps and lamp systems, which added LEDs in its scope.
On the other hand, the IEC 60825-1:2007 laser safety standard removed LEDs from its scope.
However, please be advised that some countries and regions have adopted standards based on the IEC laser safety standard IEC 60825-1:2011/2001, which still includes LEDs in its scope.
Most of Nichia's LEDs can be classified as belonging into either the Exempt Group or Risk Group 1.
High-power LEDs, that emit light containing blue wavelengths, may be classified as Risk Group 2.
Please proceed with caution when viewing directly any LEDs driven at high current, or viewing LEDs with optical instruments which may greatly increase the damages to your eyes.
- Viewing a flashing light may cause eye discomfort. When incorporating the LED into your product, please be careful to avoid adverse effects on the human body caused by light stimulation.

(9) Others

- This product is intended to be used for general lighting, household appliances, electronic devices (e.g. mobile communication devices); it is not designed or manufactured for use in applications that require safety critical functions (e.g. aircraft, automobiles, combustion equipment, life support systems, nuclear reactor control system, safety devices, spacecraft, submarine repeaters, traffic control equipment, trains, vessels, etc.). If the LEDs are planned to be used for these applications, unless otherwise detailed in the specification, Nichia will neither guarantee that the product is fit for that purpose nor be responsible for any resulting property damage, injuries and/or loss of life/health.
This product does not comply with ISO/TS 16949 and is not intended for automotive applications.
- The customer shall not reverse engineer by disassembling or analysis of the LEDs without having prior written consent from Nichia. When defective LEDs are found, the customer shall inform Nichia directly before disassembling or analysis.
- The specifications and appearance of this product may change without notice;
Nichia does not guarantee the contents of this specification. Both the customer and Nichia will agree on the official specifications of supplied products before the volume production of a program begins.