

**VI TELEFILTER**

**Filter specification**

**TFS 309A**

**1/5**

**Measurement condition**

Ambient temperature:	23	°C
Input power level:	0	dBm
Terminating impedance: *		
Input:	731,5 Ω	-4,5 pF
Output:	809,5 Ω	-3,8 pF

**Characteristics**

**Remark:**

The reference level for the relative attenuation  $a_{rel}$  of the TFS 309A is the minimum of the pass band attenuation  $a_{min}$ . The minimum of the pass band attenuation  $a_{min}$  is defined as the insertion loss  $a_e$ . The centre frequency  $f_c$  is the arithmetic mean value of the upper and lower frequencies at the 3 dB filter attenuation level relative to the insertion loss  $a_e$ . The nominal frequency  $f_N$  is fixed at 309,4 MHz without any tolerance. The given values for both the relative attenuation  $a_{rel}$  and the group delay ripple have to be achieved at the frequencies given below even if the centre frequency  $f_c$  is shifted due to the temperature coefficient of frequency  $TC_f$  in the operating temperature range and due to a production tolerance for the centre frequency  $f_c$ .

<b>D a t a</b>		<b>typ. value</b>		<b>tolerance / limit</b>	
<b>Insertion loss</b> (reference level)	$a_e$	5,3	dB	max.	7,6 dB
<b>Nominal frequency</b>	$f_N$	-			309,4 MHz
<b>Centre frequency</b>	$f_c$	309,4	MHz		-
<b>Passband</b>	PB	-		$f_N \pm$	0,25 MHz
<b>Pass band ripple</b>		0	dB	max.	0,5 dB
<b>Relative attenuation</b>	$a_{rel}$				
$f_N$	... $f_N \pm$	0,25	MHz	0,40	dB max. 0,5 dB
$f_N \pm$	0,75 MHz ... $f_N \pm$	1,5	MHz	13	dB min. 10 dB
$f_N \pm$	1,5 MHz ... $f_N \pm$	3,0	MHz	46	dB min. 40 dB
$f_N \pm$	3,0 MHz ... $f_N \pm$	4,5	MHz	53	dB min. 50 dB
$f_N -$	21,4 MHz			64	dB min. 60 dB
$f_N \pm$	50,0 MHz ... $f_N \pm$	300,0	MHz	57	dB min. 50 dB
<b>Group delay ripple within PB</b>		166	ns	max.	500 ns
<b>IIP3</b>	**	33	dBm	min.	30 dBm
<b>Input power level</b>		-		max.	15 dBm
<b>Operating temperature range</b>	OTR	-			- 40 °C ... + 85°C
<b>Storage temperature range</b>		-			- 55 °C ... +105°C
<b>Frequency inversion temperature</b>		23	°C		
<b>Temperature coefficient of frequency</b>	$TC_f$ ***	-0,043	ppm/K <sup>2</sup>		

\*) The terminating impedances depend on parasitics and q-values of matching elements and the board used, and are to be understood as reference values only. Should there be additional questions do not hesitate to ask for an application note or contact our design team.

\*\*\*)  $f_{in1} = 309,35$  MHz;  $f_{in2} = 309,3$  MHz;  $P_{in} = -10$  dBm  $f_{measurement} = 309,4$  MHz and  $f_{in1} = 309,45$  MHz;  $f_{in2} = 304,5$  MHz;  $P_{in} = -10$  dBm  $f_{measurement} = 309,4$  MHz.

\*\*\*)  $\Delta f(\text{Hz}) = TC_f(\text{ppm/K}^2) \times (T - T_0)^2 \times f_{T0}(\text{MHz})$

**Generated:**

**Checked / Approved:**

**Tele Filter GmbH**  
**Potsdamer Straße 18**  
**D 14 513 TELTOW / Germany**  
**Tel: (+49) 3328 4784-0 / Fax: (+49) 3328 4784-30**  
**E-Mail: [tft@telefilter.com](mailto:tft@telefilter.com)**

VI TELEFILTER reserves the right to make changes to the product(s) and/or information contained herein without notice. No liability is assumed as a result of their use or application. No rights under any patent accompany the sale of any such product(s) or information.

**Filter characteristic**

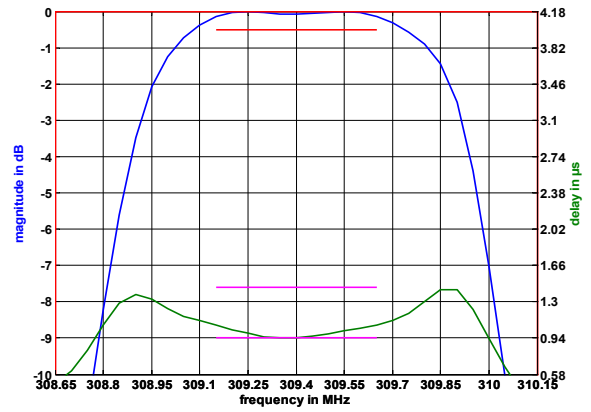
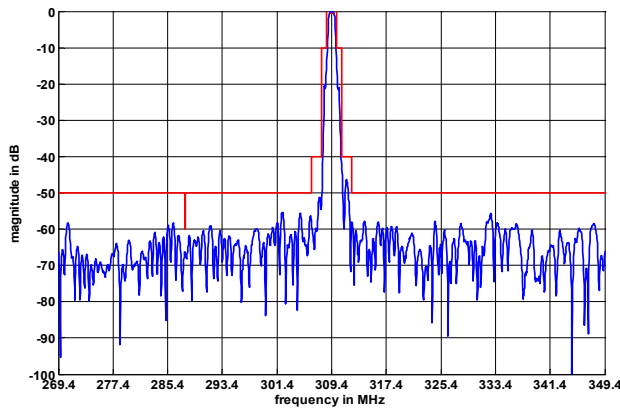

**Construction and pin connection**

(All dimensions in mm)

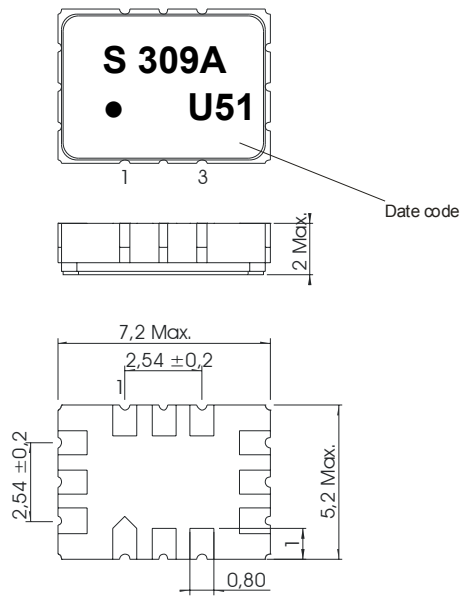

- 1 Input
- 2 Input RF Return
- 3 Ground
- 4 Ground
- 5 Ground
- 6 Ground
- 7 Output
- 8 Output RF Return
- 9 Ground
- 10 Ground
- 11 Ground
- 12 Ground

Date code: Year + week  
 U 2006  
 V 2007  
 W 2008  
 ...

**50 Ω Test circuit**

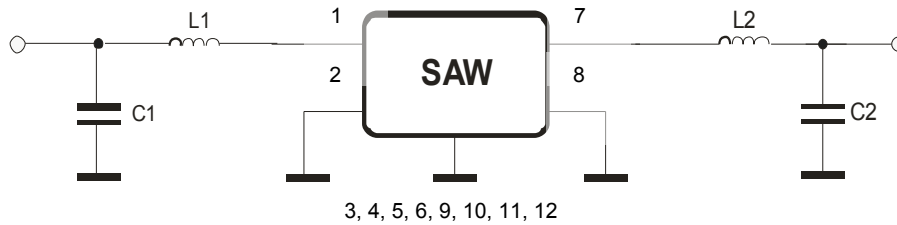

**Tele Filter GmbH**  
 Potsdamer Straße 18  
 D 14 513 TELTOW / Germany  
 Tel: (+49) 3328 4784-0 / Fax: (+49) 3328 4784-30  
 E-Mail: [tft@telefilter.com](mailto:tft@telefilter.com)

VI TELEFILTER reserves the right to make changes to the product(s) and/or information contained herein without notice. No liability is assumed as a result of their use or application. No rights under any patent accompany the sale of any such product(s) or information.

**Stability characteristics, reliability**

After the following tests the filter shall meet the whole specification:

1. Shock: 500g, 1 ms, half sine wave, 3 shocks each plane;  
DIN IEC 68 T2 - 27
2. Vibration: 10 Hz to 500 Hz, 0,35 mm or 5 g respectively, 1 octave per min, 10 cycles per plan, 3 plans;  
DIN IEC 68 T2 - 6
3. Change of temperature: -55 °C to 125°C / 30 min. each / 10 cycles  
DIN IEC 68 part 2 – 14 Test N
4. Resistance to solder heat (reflow): reflow possible: three times max.;  
for temperature conditions refer to the attached "Air reflow temperature conditions" on page 4;

This filter is RoHS compliant (2002/95/EG, 2005/618/EG)

**Packing**

Tape & Reel: IEC 286 – 3, with exception of value for N and minimum bending radius;  
tape type II, embossed carrier tape with top cover tape on the upper side;

max. pieces of filters per reel:	3000
reel of empty components at start:	min. 300 mm
reel of empty components at start including leader:	min. 500 mm
trailer:	min. 300 mm

**Tape (all dimensions in mm)**

- W : 16,00 ± 0,3
- Po : 4,00 ± 0,1
- Do : 1,50 +0,1/-0
- E : 1,75 ± 0,1
- F : 7,50 ± 0,1
- G(min) : 0,60
- P2 : 2,00 ± 0,1
- P1 : 8,00 ± 0,1
- D1(min) : 1,50
- Ao : 5,50 ± 0,1
- Bo : 7,50 ± 0,1
- Ct : 13,5 ± 0,1

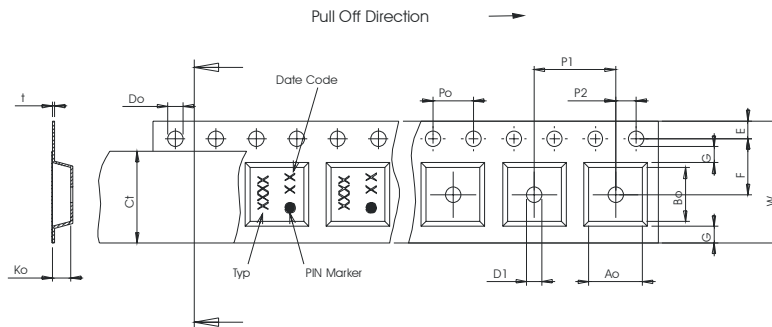

**Reel (all dimensions in mm)**

- A : 330
- W1 : 16,4 +2/-0
- W2(max) : 22,4
- N(min) : 50
- C : 13,0 +0,5/-0,2

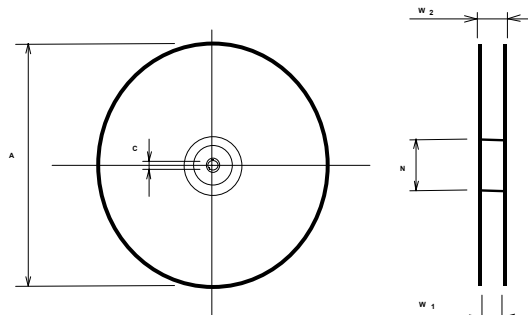

The minimum bending radius is 45 mm.

**Tele Filter GmbH**  
**Potsdamer Straße 18**  
**D 14 513 TELTOW / Germany**  
**Tel: (+49) 3328 4784-0 / Fax: (+49) 3328 4784-30**  
**E-Mail: [tft@telefilter.com](mailto:tft@telefilter.com)**

VI TELEFILTER reserves the right to make changes to the product(s) and/or information contained herein without notice. No liability is assumed as a result of their use or application. No rights under any patent accompany the sale of any such product(s) or information.

**Air reflow temperature conditions**

Conditions	Exposure
Average ramp-up rate (30°C to 217°C)	less than 3°C/second
> 100°C	between 300 and 600 seconds
> 150°C	between 240 and 500 seconds
> 217°C	between 30 and 150 seconds
Peak temperature	max. 260°C
Time within 5°C of actual peak temperature	between 10 and 30 seconds
Cool-down rate (Peak to 50°C)	less than 6°C/second
Time from 30°C to Peak temperature	no greater than 300 seconds

**Chip-mount air reflow profile**

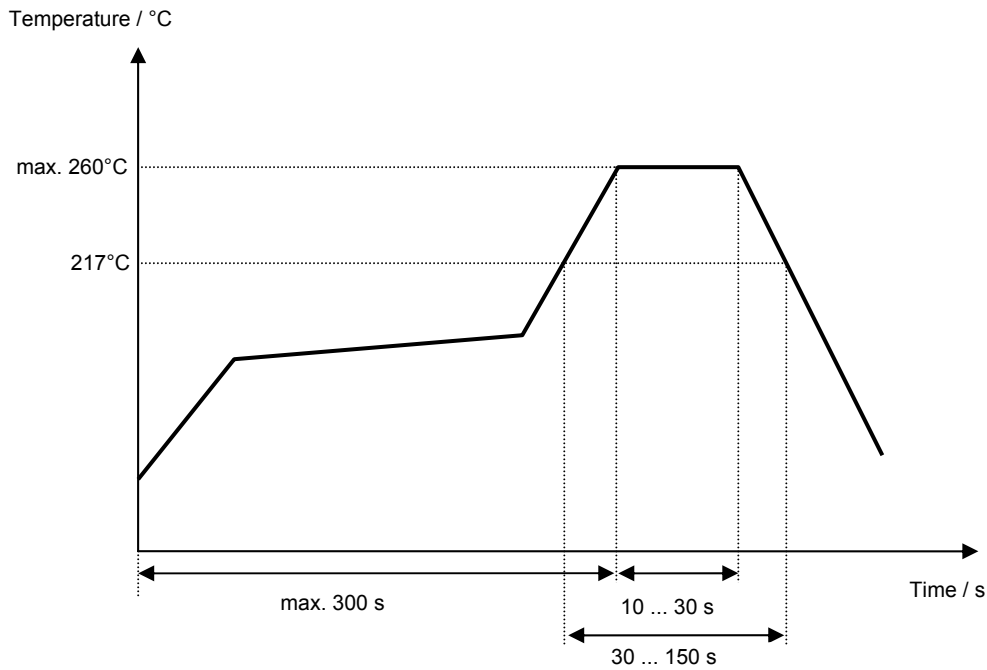

**Tele Filter GmbH**  
**Potsdamer Straße 18**  
**D 14 513 TELTOW / Germany**  
**Tel: (+49) 3328 4784-0 / Fax: (+49) 3328 4784-30**  
**E-Mail: [tft@telefilter.com](mailto:tft@telefilter.com)**

VI TELEFILTER reserves the right to make changes to the product(s) and/or information contained herein without notice. No liability is assumed as a result of their use or application. No rights under any patent accompany the sale of any such product(s) or information.

**VI TELEFILTER****Filter specification****TFS 309A****5/5****History**

<b>Version</b>	<b>Reason of Changes</b>	<b>Name</b>	<b>Date</b>
1.0	- Generation of development specification	Strehl	20.02.2006
1.1	- Change input power level and storage temperature range	Strehl	23.03.2006
1.2	- Change from development specification to filter specification - Change Intermodulation value - Add terminating impedance value - Add typical values - Add filter characteristics - Add matching circuit	Alawneh	08.11.2007

---

**Tele Filter GmbH**  
**Potsdamer Straße 18**  
**D 14 513 TELTOW / Germany**  
**Tel: (+49) 3328 4784-0 / Fax: (+49) 3328 4784-30**  
**E-Mail: [tft@telefilter.com](mailto:tft@telefilter.com)**

VI TELEFILTER reserves the right to make changes to the product(s) and/or information contained herein without notice. No liability is assumed as a result of their use or application. No rights under any patent accompany the sale of any such product(s) or information.