



ON Semiconductor®

# FAN3100C / FAN3100T

## Single 2 A High-Speed, Low-Side Gate Driver

### Features

- 3 A Peak Sink/Source at  $V_{DD} = 12\text{ V}$
- 4.5 to 18 V Operating Range
- 2.5 A Sink / 1.8 A Source at  $V_{OUT} = 6\text{ V}$
- Dual-Logic Inputs Allow Configuration as Non-Inverting or Inverting with Enable Function
- Internal Resistors Turn Driver Off If No Inputs
- 13 ns Typical Rise Time and 9 ns Typical Fall-Time with 1 nF Load
- Choice of TTL or CMOS Input Thresholds
- MillerDrive™ Technology
- Typical Propagation Delay Time Under 20 ns with Input Falling or Rising
- 6-Lead, 2x2 mm MLP or 5-Pin, SOT23 Packages
- Rated from  $-40^{\circ}\text{C}$  to  $125^{\circ}\text{C}$  Ambient

### Applications

- Switched-Mode Power Supplies (SMPS)
- High-Efficiency MOSFET Switching
- Synchronous Rectifier Circuits
- DC-to-DC Converters
- Motor Control

### Description

The FAN3100 2 A gate driver is designed to drive an N-channel enhancement-mode MOSFET in low-side switching applications by providing high peak current pulses during the short switching intervals. The driver is available with either TTL (FAN3100T) or CMOS (FAN3100C) input thresholds. Internal circuitry provides an under-voltage lockout function by holding the output LOW until the supply voltage is within the operating range. The FAN3100 delivers fast MOSFET switching performance, which helps maximize efficiency in high-frequency power converter designs.

FAN3100 drivers incorporate MillerDrive™ architecture for the final output stage. This bipolar-MOSFET combination provides high peak current during the Miller plateau stage of the MOSFET turn-on / turn-off process to minimize switching loss, while providing rail-to-rail voltage swing and reverse current capability.

The FAN3100 also offers dual inputs that can be configured to operate in non-inverting or inverting mode and allow implementation of an enable function. If one or both inputs are left unconnected, internal resistors bias the inputs such that the output is pulled LOW to hold the power MOSFET off.

The FAN3100 is available in a lead-free finish, 2x2 mm, 6-lead, Molded Leadless Package (MLP) for the smallest size with excellent thermal performance; or industry-standard, 5-pin, SOT23.

### Functional Pin Configurations

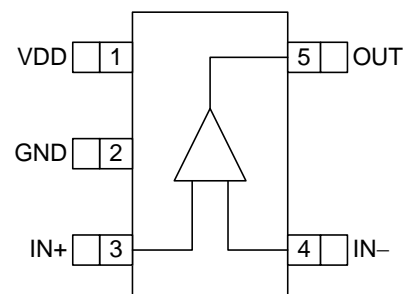
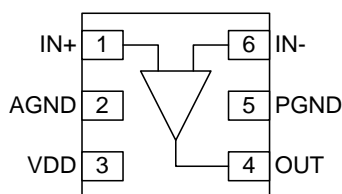

Figure 1. 6-Lead MLP (Top View)

Figure 2. SOT23-5 (Top View)

### Ordering Information

Part Number	Input Threshold	Package	Packing Method	Quantity / Reel
FAN3100CMPX	CMOS	6-Lead, 2x2 mm MLP	Tape & Reel	3000
FAN3100CSX	CMOS	5-Pin, SOT23	Tape & Reel	3000
FAN3100TMPX	TTL	6-Lead, 2x2 mm MLP	Tape & Reel	3000
FAN3100TSX	TTL	5-Pin, SOT23	Tape & Reel	3000

### Package Outlines

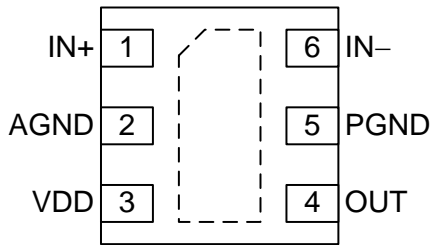

Figure 3. 6-Lead MLP (Top View)

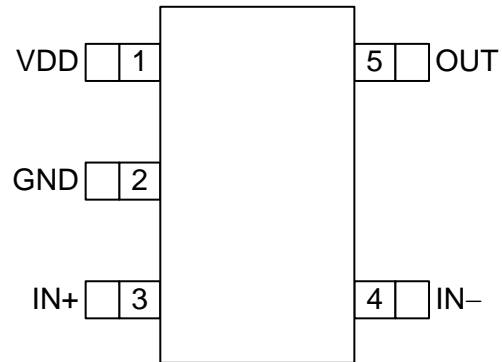

Figure 4. SOT23-5 (Top View)

### Thermal Characteristics<sup>(1)</sup>

Package	$\Theta_{JL}$ <sup>(2)</sup>	$\Theta_{JT}$ <sup>(3)</sup>	$\Theta_{JA}$ <sup>(4)</sup>	$\Psi_{JB}$ <sup>(5)</sup>	$\Psi_{JT}$ <sup>(6)</sup>	Units
6-Lead, 2x2 mm Molded Leadless Package (MLP)	2.7	133	58	2.8	42	°C/W
SOT23-5	56	99	157	51	5	°C/W

**Notes:**

- Estimates derived from thermal simulation; actual values depend on the application.
- $\Theta_{JL}$  ( $\Theta_{JL}$ ): Thermal resistance between the semiconductor junction and the bottom surface of all the leads (including any thermal pad) that are typically soldered to a PCB.
- $\Theta_{JT}$  ( $\Theta_{JT}$ ): Thermal resistance between the semiconductor junction and the top surface of the package, assuming it is held at a uniform temperature by a top-side heatsink.
- $\Theta_{JA}$  ( $\Theta_{JA}$ ): Thermal resistance between junction and ambient, dependent on the PCB design, heat sinking, and airflow. The value given is for natural convection with no heatsink using a 2SP2 board, as specified in JEDEC standards JESD51-2, JESD51-5, and JESD51-7, as appropriate.
- $\Psi_{JB}$  ( $\Psi_{JB}$ ): Thermal characterization parameter providing correlation between semiconductor junction temperature and an application circuit board reference point for the thermal environment defined in Note 4. For the MLP-6 package, the board reference is defined as the PCB copper connected to the thermal pad and protruding from either end of the package. For the SOT23-5 package, the board reference is defined as the PCB copper adjacent to pin 2.
- $\Psi_{JT}$  ( $\Psi_{JT}$ ): Thermal characterization parameter providing correlation between the semiconductor junction temperature and the center of the top of the package for the thermal environment defined in Note 4.

## Pin Definitions

SOT23 Pin #	MLP Pin #	Name	Pin Description
1	3	VDD	<b>Supply Voltage</b> . Provides power to the IC.
	2	AGND	<b>Analog ground</b> for input signals (MLP only). Connect to PGND underneath the IC.
2		GND	<b>Ground</b> (SOT-23 only). Common ground reference for input and output circuits.
3	1	IN+	<b>Non-Inverting Input</b> . Connect to VDD to enable output.
4	6	IN-	<b>Inverting Input</b> . Connect to AGND or PGND to enable output.
5	4	OUT	<b>Gate Drive Output</b> : Held LOW unless required inputs are present and $V_{DD}$ is above UVLO threshold.
	Pad	P1	<b>Thermal Pad</b> (MLP only). Exposed metal on the bottom of the package, which is electrically connected to pin 5.
	5	PGND	<b>Power Ground</b> (MLP only). For output drive circuit; separates switching noise from inputs.

## Output Logic

IN+	IN-	OUT
0 <sup>(7)</sup>	0	0
0 <sup>(7)</sup>	1 <sup>(7)</sup>	0
1	0	1
1	1 <sup>(7)</sup>	0

**Note:**

7. Default input signal if no external connection is made.

Block Diagrams

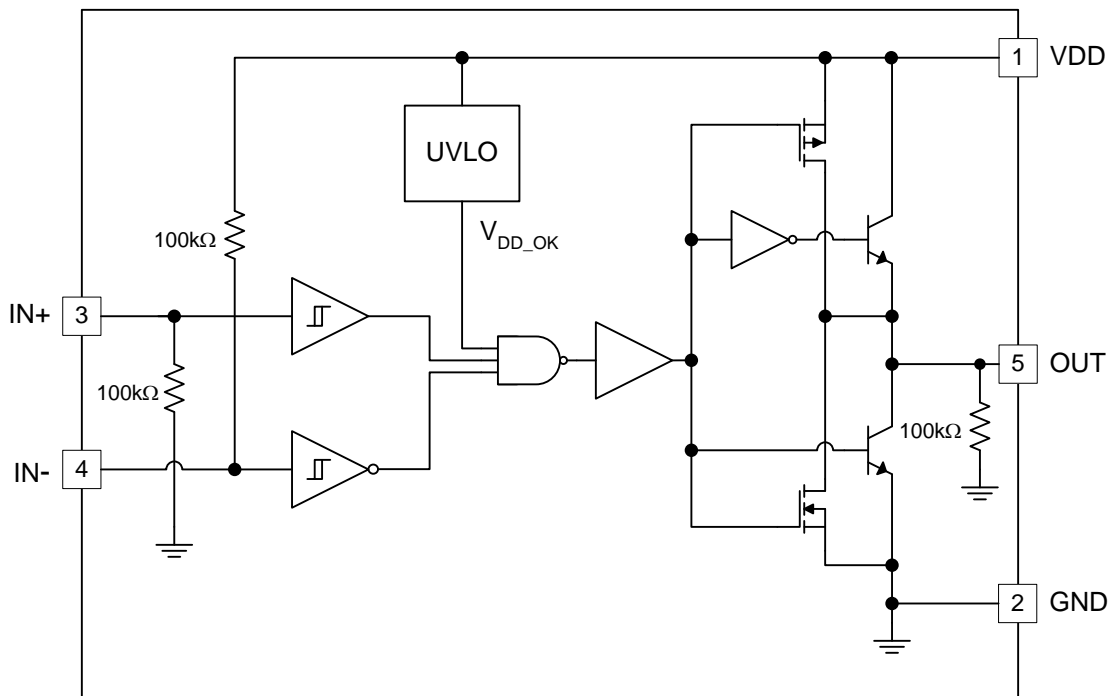

Figure 5. Simplified Block Diagram (SOT23 Pin-out)

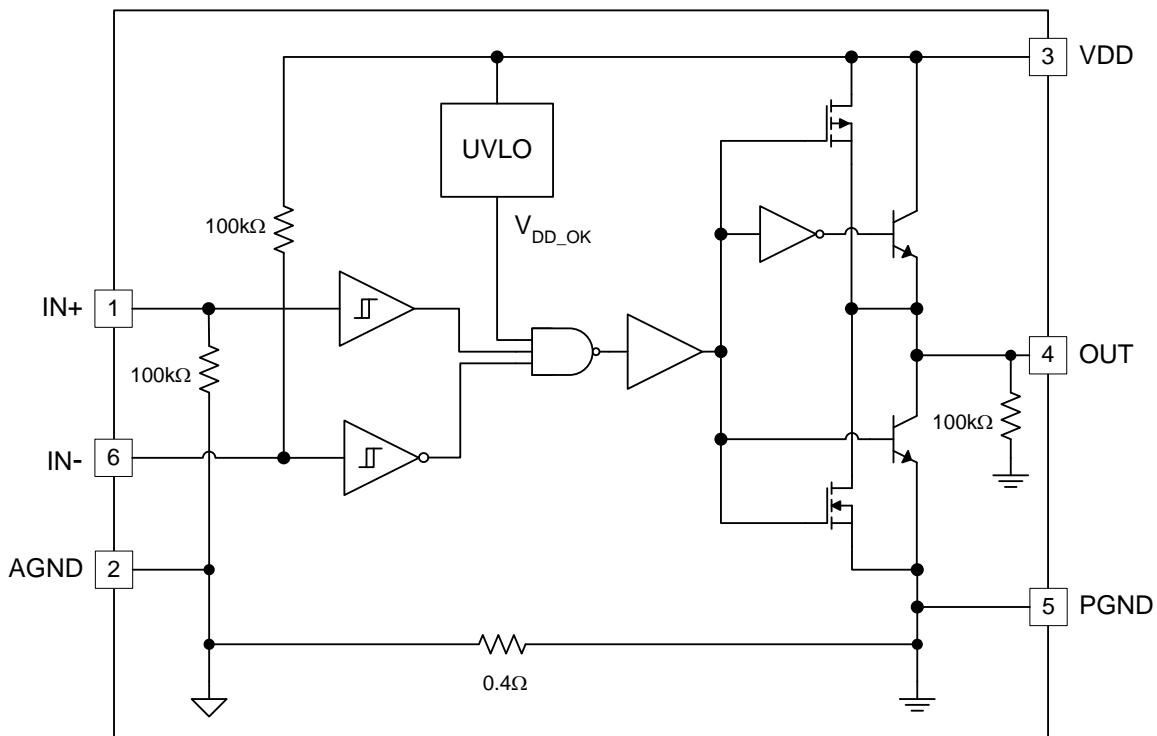

Figure 6. Simplified Block Diagram (MLP Pin-out)

## Absolute Maximum Ratings

Stresses exceeding the absolute maximum ratings may damage the device. The device may not function or be operable above the recommended operating conditions and stressing the parts to these levels is not recommended. In addition, extended exposure to stresses above the recommended operating conditions may affect device reliability. The absolute maximum ratings are stress ratings only.

Symbol	Parameter	Min.	Max.	Unit
$V_{DD}$	VDD to PGND	-0.3	20.0	V
$V_{IN}$	Voltage on IN+ and IN- to GND, AGND, or PGND	GND - 0.3	$V_{DD} + 0.3$	V
$V_{OUT}$	Voltage on OUT to GND, AGND, or PGND	GND - 0.3	$V_{DD} + 0.3$	V
$T_L$	Lead Soldering Temperature (10 Seconds)		+260	°C
$T_J$	Junction Temperature	-55	+150	°C
$T_{STG}$	Storage Temperature	-65	+150	°C

## Recommended Operating Conditions

The Recommended Operating Conditions table defines the conditions for actual device operation. Recommended operating conditions are specified to ensure optimal performance to the datasheet specifications. ON Semiconductor does not recommend exceeding them or designing to Absolute Maximum Ratings.

Symbol	Parameter	Min.	Max.	Unit
$V_{DD}$	Supply Voltage Range	4.5	18.0	V
$V_{IN}$	Input Voltage IN+, IN-	0	$V_{DD}$	V
$T_A$	Operating Ambient Temperature	-40	+125	°C

## Electrical Characteristics

Unless otherwise noted,  $V_{DD} = 12\text{ V}$ ,  $T_J = -40^\circ\text{C}$  to  $+125^\circ\text{C}$ . Currents are defined as positive into the device and negative out of the device.

Symbol	Parameter	Conditions	Min.	Typ.	Max.	Unit
<b>Supply</b>						
$V_{DD}$	Operating Range		4.5		18.0	V
$I_{DD}$	Supply Current Inputs/EN Not Connected	FAN3100C <sup>(8)</sup>		0.20	0.35	mA
		FAN3100T		0.50	0.80	mA
$V_{ON}$	Turn-On Voltage		3.5	3.9	4.3	V
$V_{OFF}$	Turn-Off Voltage		3.3	3.7	4.1	V
<b>Inputs (FAN3100T)</b>						
$V_{INL\_T}$	IN+, IN- Logic LOW Voltage, Maximum		0.8			V
$V_{INH\_T}$	IN+, IN- Logic HIGH Voltage, Minimum				2.0	V
$I_{IN+}$	Non-inverting Input	IN from 0 to $V_{DD}$	-1		175	$\mu\text{A}$
$I_{IN-}$	Inverting Input	IN from 0 to $V_{DD}$	-175		1	$\mu\text{A}$
$V_{HYS}$	IN+, IN- Logic Hysteresis Voltage		0.2	0.4	0.8	V
<b>Inputs (FAN3100C)</b>						
$V_{INL\_C}$	IN+, IN- Logic LOW Voltage		30			$\%V_{DD}$
$V_{INH\_C}$	IN+, IN- Logic HIGH Voltage				70	$\%V_{DD}$
$I_{INL}$	IN Current, LOW	IN from 0 to $V_{DD}$	-1		175	$\mu\text{A}$
$I_{INH}$	IN Current, HIGH	IN from 0 to $V_{DD}$	-175		1	$\mu\text{A}$
$V_{HYS\_C}$	IN+, IN- Logic Hysteresis Voltage			17		$\%V_{DD}$
<b>Output</b>						
$I_{SINK}$	OUT Current, Mid-Voltage, Sinking <sup>(9)</sup>	OUT at $V_{DD}/2$ , $C_{LOAD} = 0.1\ \mu\text{F}$ , $f = 1\ \text{kHz}$		2.5		A
$I_{SOURCE}$	OUT Current, Mid-Voltage, Sourcing <sup>(9)</sup>	OUT at $V_{DD}/2$ , $C_{LOAD} = 0.1\ \mu\text{F}$ , $f = 1\ \text{kHz}$		-1.8		A
$I_{PK\_SINK}$	OUT Current, Peak, Sinking <sup>(9)</sup>	$C_{LOAD} = 0.1\ \mu\text{F}$ , $f = 1\ \text{kHz}$		3		A
$I_{PK\_SOURCE}$	OUT Current, Peak, Sourcing <sup>(9)</sup>	$C_{LOAD} = 0.1\ \mu\text{F}$ , $f = 1\ \text{kHz}$		-3		A
$t_{RISE}$	Output Rise Time <sup>(10)</sup>	$C_{LOAD} = 1000\ \text{pF}$		13	20	ns
$t_{FALL}$	Output Fall Time <sup>(10)</sup>	$C_{LOAD} = 1000\ \text{pF}$		9	14	ns
$t_{D1}, t_{D2}$	Output Prop. Delay, CMOS Inputs <sup>(10)</sup>	0 – 12 $V_{IN}$ ; 1 V/ns Slew Rate	7	15	28	ns
$t_{D1}, t_{D2}$	Output Prop. Delay, TTL Inputs <sup>(10)</sup>	0 – 5 $V_{IN}$ ; 1 V/ns Slew Rate	9	16	30	ns
$I_{RVS}$	Output Reverse Current Withstand <sup>(9)</sup>			500		mA

### Notes:

8. Lower supply current due to inactive TTL circuitry.
9. Not tested in production.
10. See *Timing Diagrams of Figure 7 and Figure 8*.

Timing Diagrams

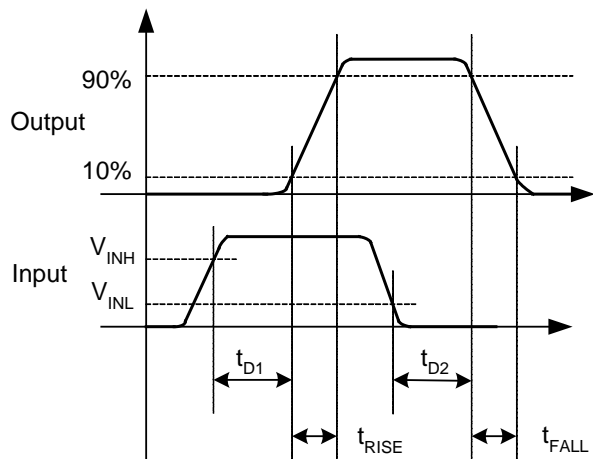

Figure 7. Non-Inverting

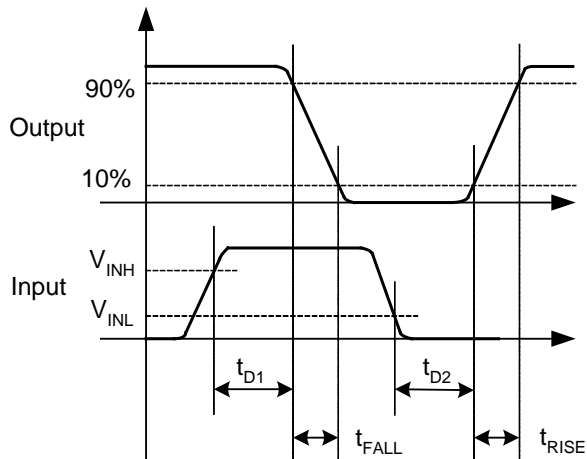

Figure 8. Inverting

## Typical Performance Characteristics

Typical characteristics are provided at 25°C and  $V_{DD}=12\text{ V}$  unless otherwise noted.

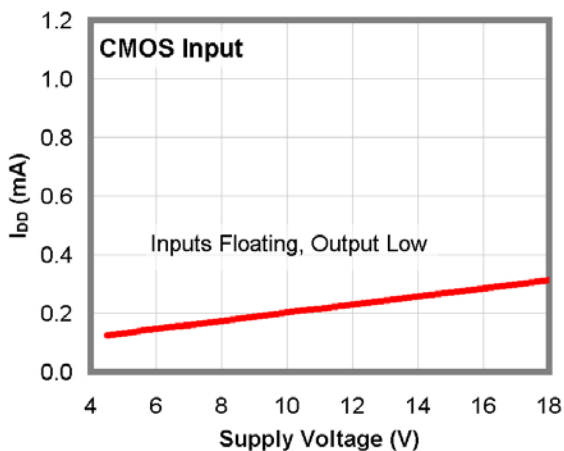

Figure 9.  $I_{DD}$  (Static) vs. Supply Voltage

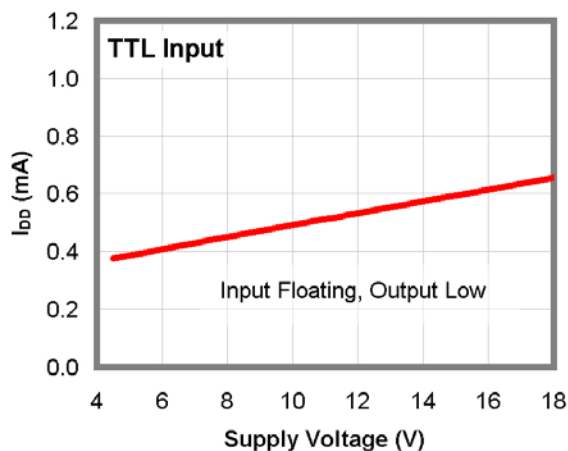

Figure 10.  $I_{DD}$  (Static) vs. Supply Voltage

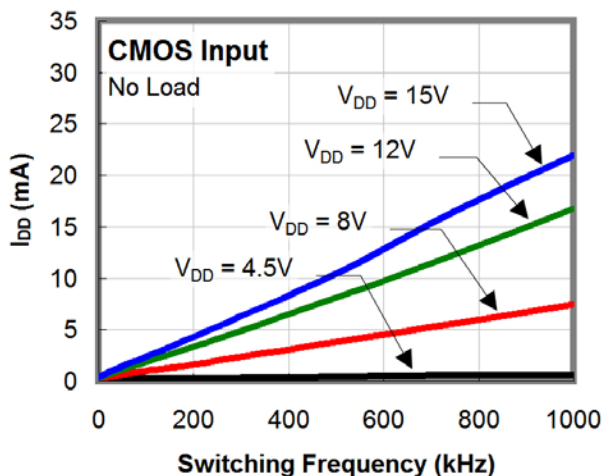

Figure 11.  $I_{DD}$  (No-Load) vs. Frequency

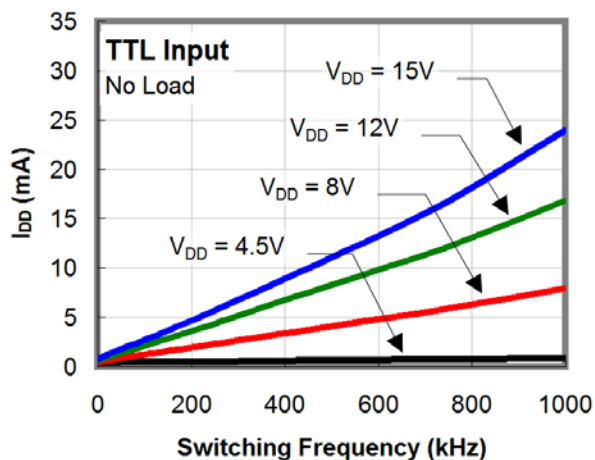

Figure 12.  $I_{DD}$  (No-Load) vs. Frequency

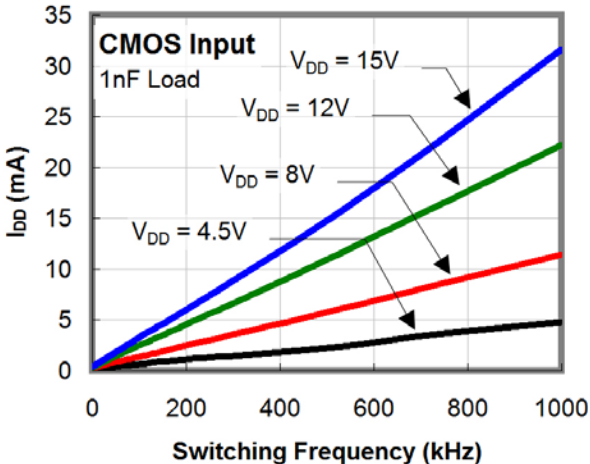

Figure 13.  $I_{DD}$  (1 nF Load) vs. Frequency

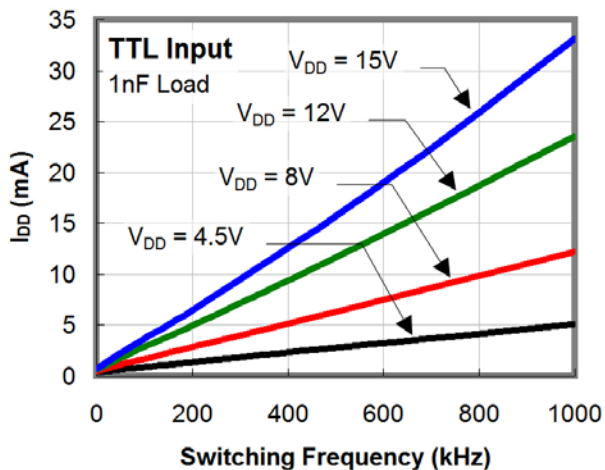

Figure 14.  $I_{DD}$  (1 nF Load) vs. Frequency



## Typical Performance Characteristics

Typical characteristics are provided at 25°C and  $V_{DD}=12\text{ V}$  unless otherwise noted.

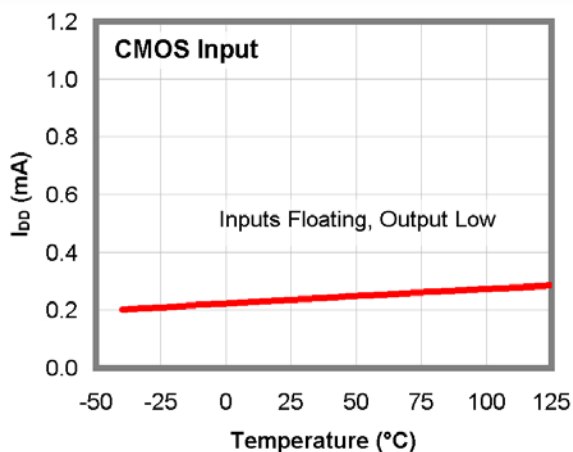

Figure 15.  $I_{DD}$  (Static) vs. Temperature

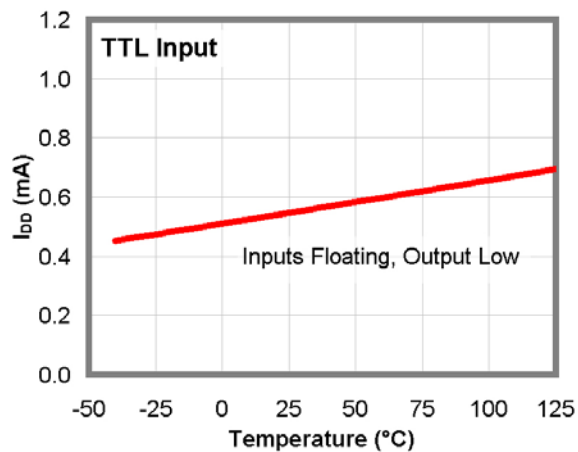

Figure 16.  $I_{DD}$  (Static) vs. Temperature

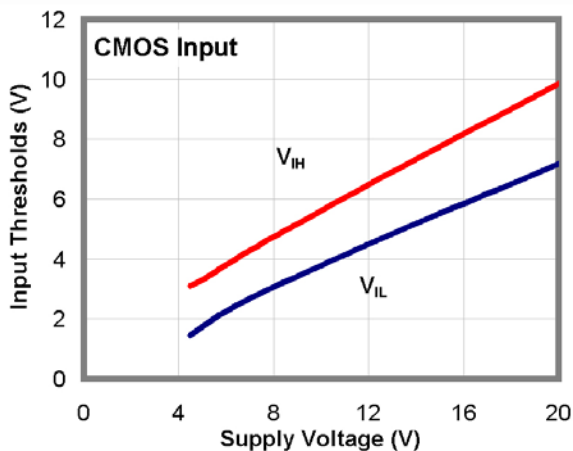

Figure 17. Input Thresholds vs. Supply Voltage

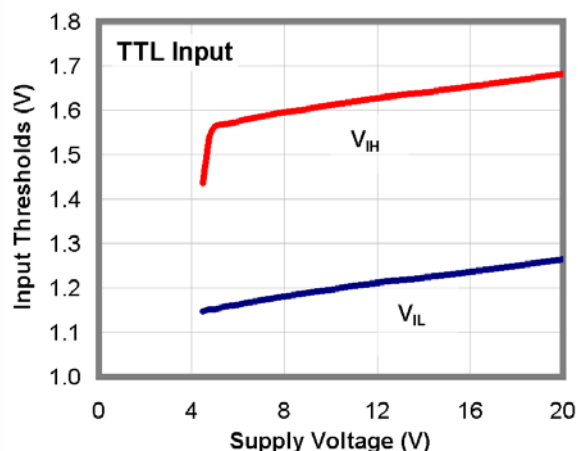

Figure 18. Input Thresholds vs. Supply Voltage

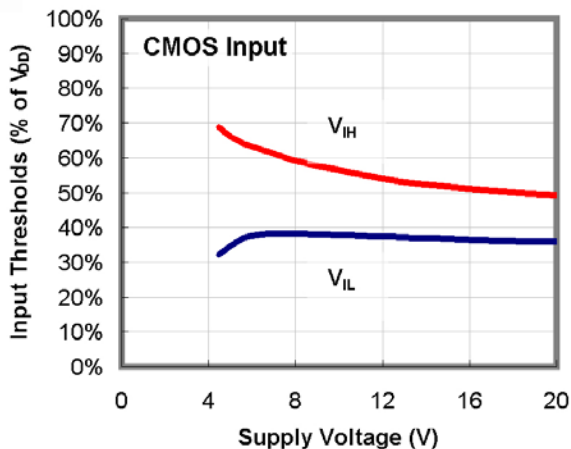

Figure 19. Input Thresholds % vs. Supply Voltage

## Typical Performance Characteristics

Typical characteristics are provided at 25°C and  $V_{DD}=12\text{ V}$  unless otherwise noted.

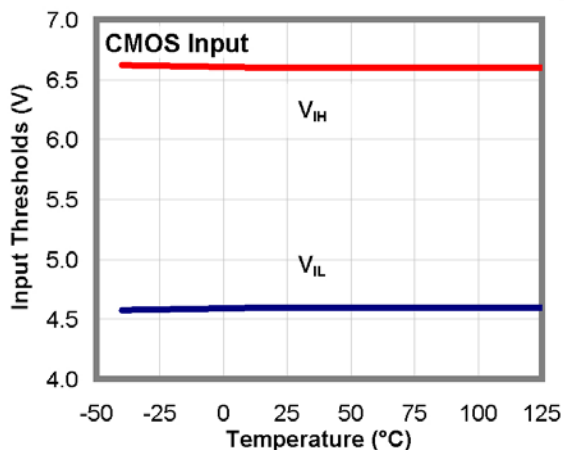

Figure 20. CMOS Input Thresholds vs. Temperature

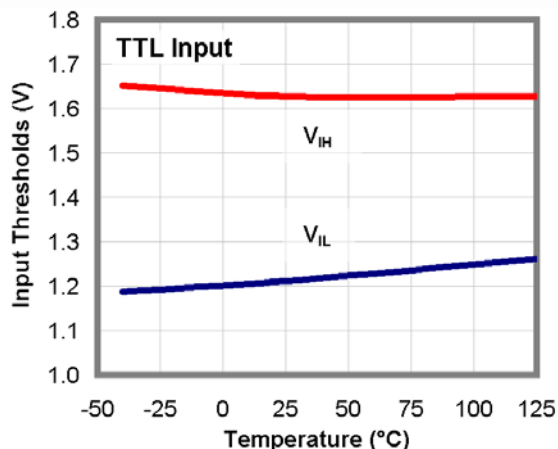

Figure 21. TTL Input Thresholds vs. Temperature

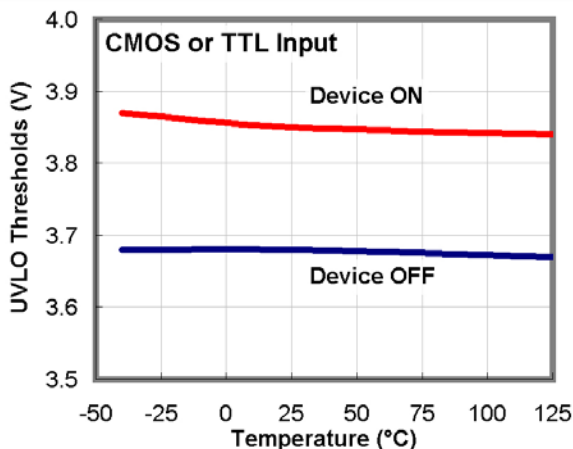

Figure 22. UVLO Thresholds vs. Temperature

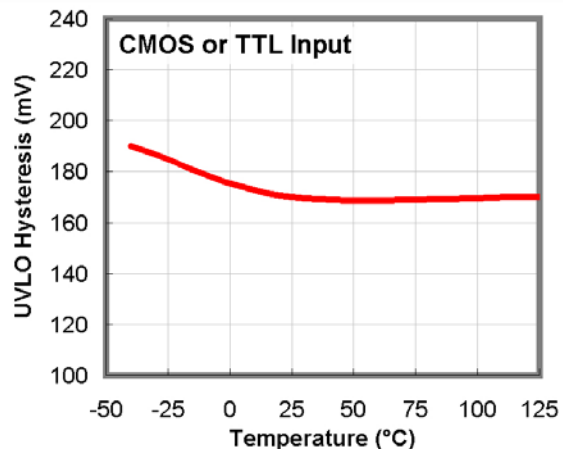

Figure 23. UVLO Hysteresis vs. Temperature

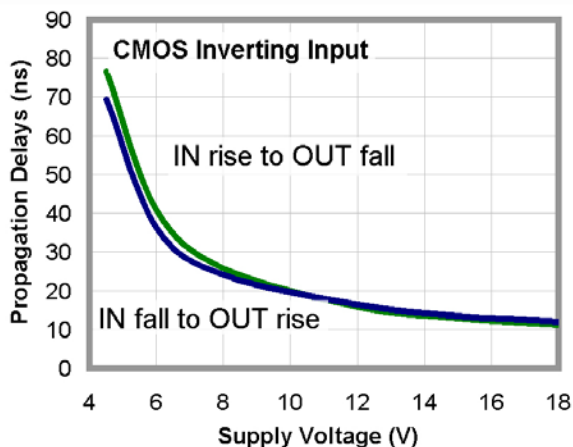

Figure 24. Propagation Delay vs. Supply Voltage

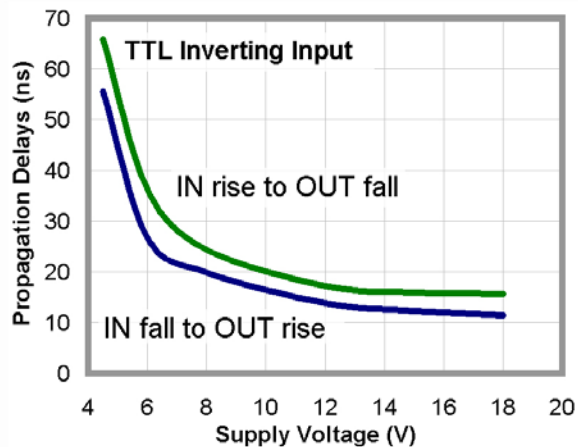

Figure 25. Propagation Delay vs. Supply Voltage

## Typical Performance Characteristics

Typical characteristics are provided at 25°C and  $V_{DD}=12\text{ V}$  unless otherwise noted.

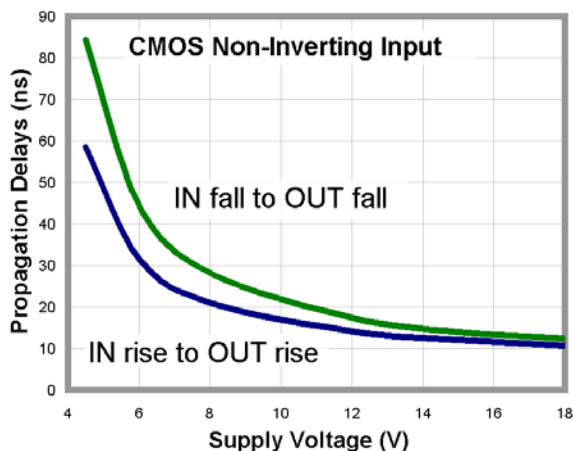

Figure 26. Propagation Delay vs. Supply Voltage

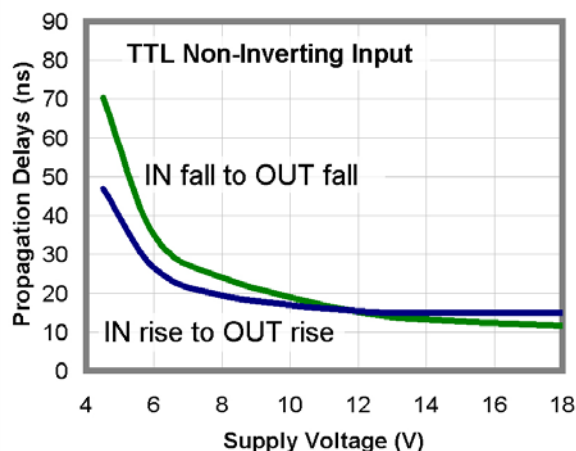

Figure 27. Propagation Delay vs. Supply Voltage

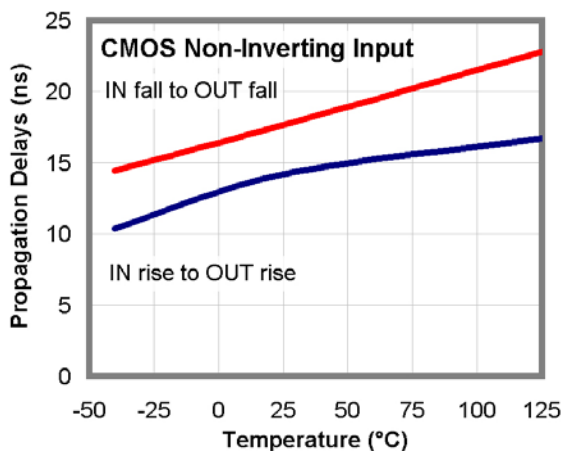

Figure 28. Propagation Delay vs. Temperature

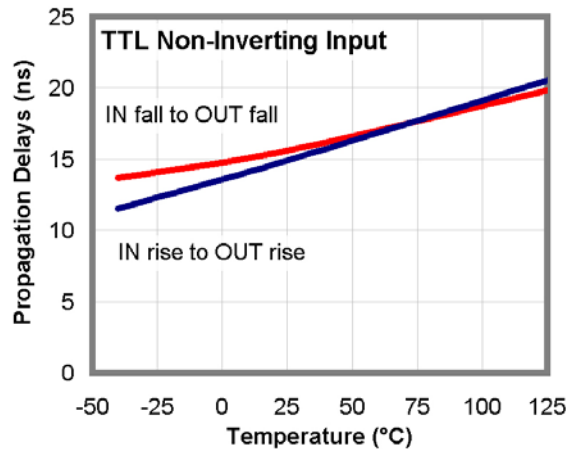

Figure 29. Propagation Delay vs. Temperature

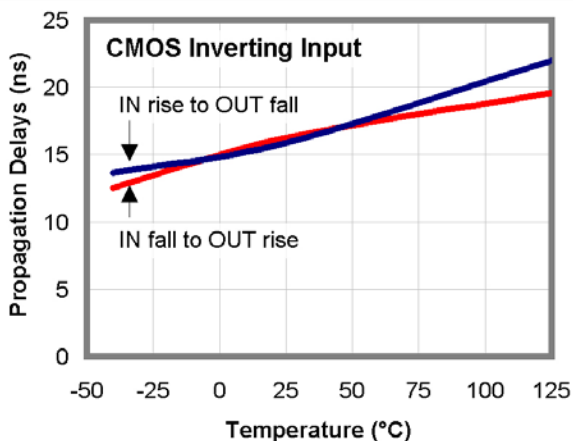

Figure 30. Propagation Delay vs. Temperature

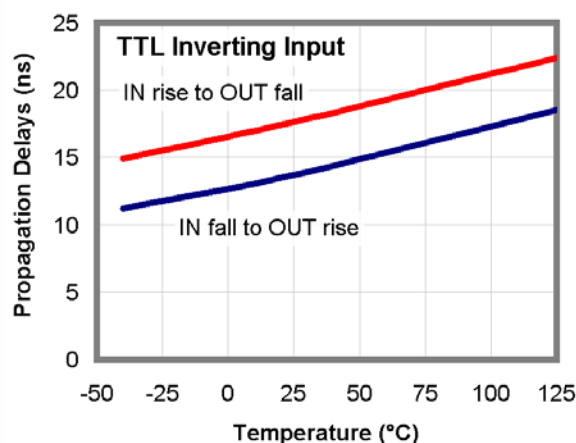

Figure 31. Propagation Delay vs. Temperature

## Typical Performance Characteristics

Typical characteristics are provided at 25°C and  $V_{DD}=12\text{ V}$  unless otherwise noted.

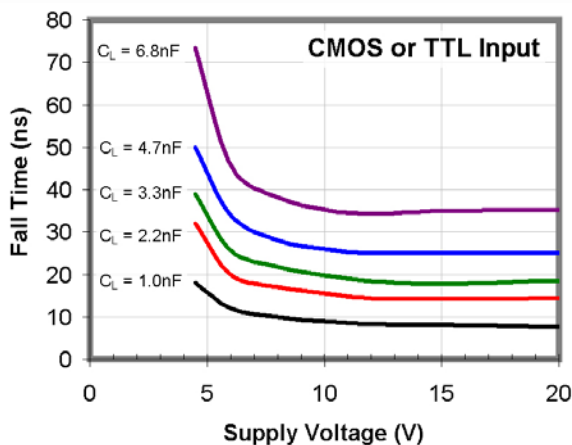

Figure 32. Fall Time vs. Supply Voltage

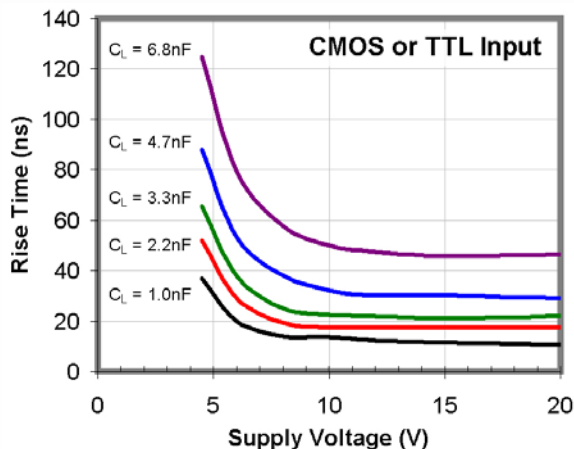

Figure 33. Rise Time vs. Supply Voltage

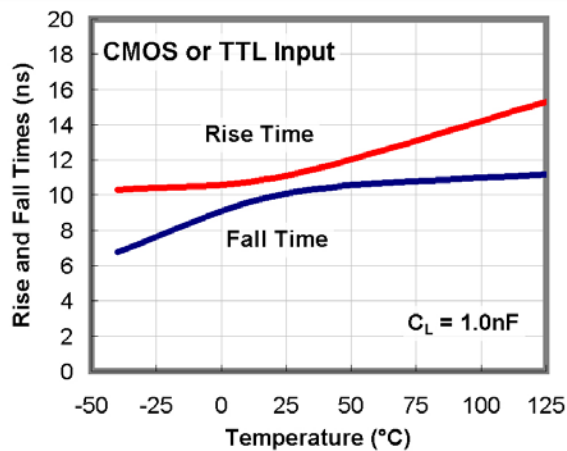

Figure 34. Rise and Fall Time vs. Temperature

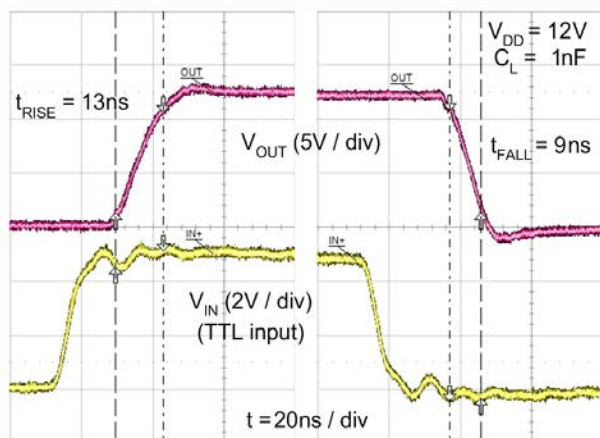

Figure 35. Rise / Fall Waveforms with 1 nF Load

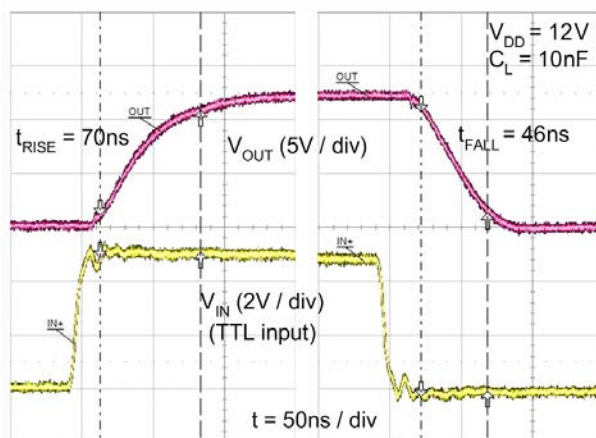

Figure 36. Rise / Fall Waveforms with 10 nF Load

## Typical Performance Characteristics

Typical characteristics are provided at 25°C and  $V_{DD}=12\text{ V}$  unless otherwise noted.

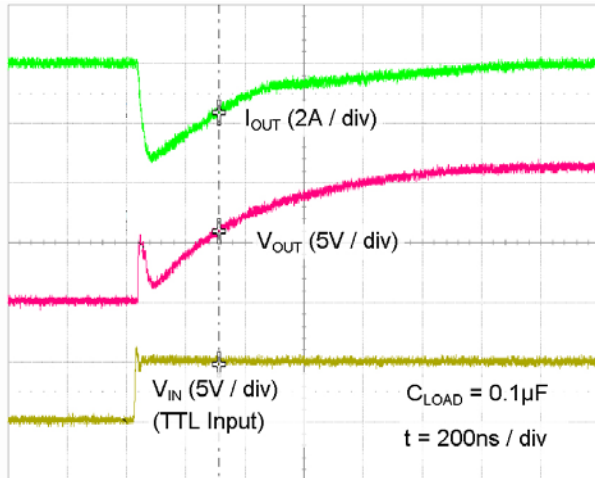

Figure 37. Quasi-Static Source Current with  $V_{DD}=12\text{ V}$

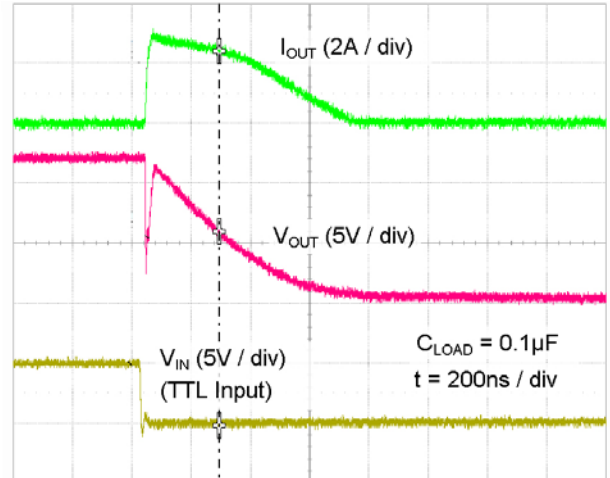

Figure 38. Quasi-Static Sink Current with  $V_{DD}=12\text{ V}$

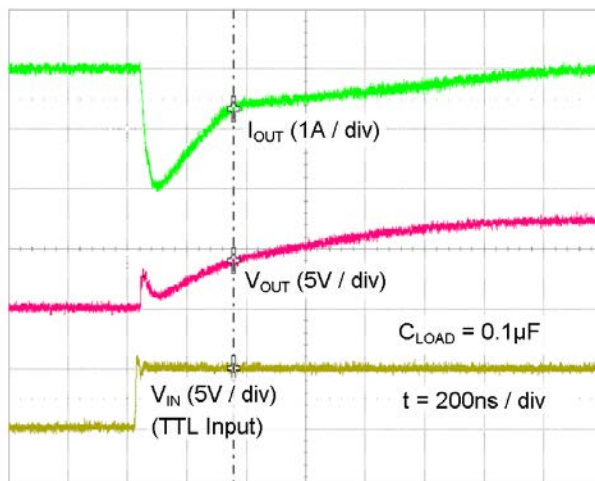

Figure 39. Quasi-Static Source Current with  $V_{DD}=8\text{ V}$

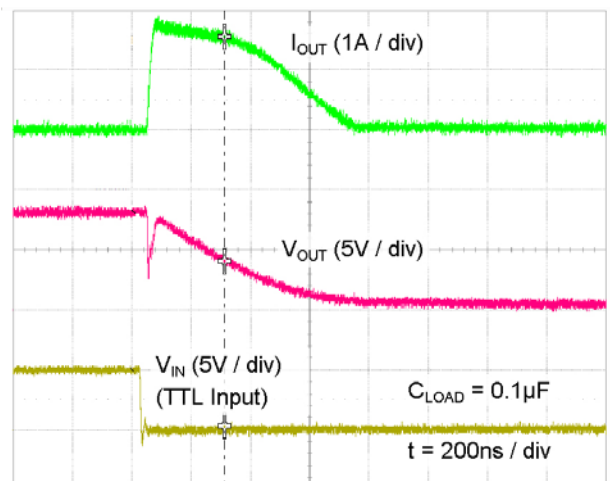

Figure 40. Quasi-Static Sink Current with  $V_{DD}=8\text{ V}$

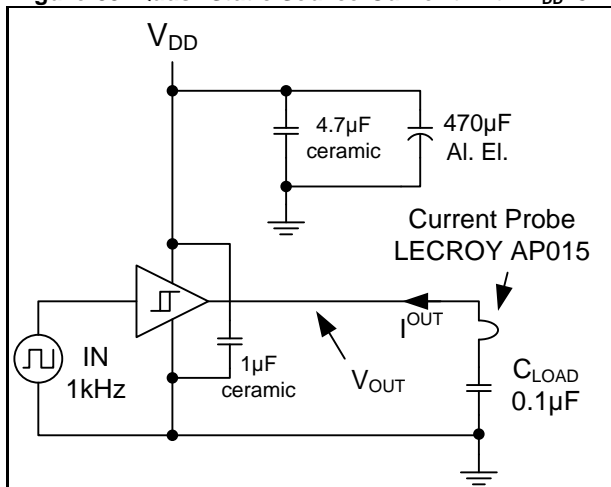

Figure 41. Quasi-Static  $I_{OUT}/V_{OUT}$  Test Circuit

## Applications Information

### Input Thresholds

The FAN3100 offers TTL or CMOS input thresholds. In the FAN3100T, the input thresholds meet industry-standard TTL logic thresholds, independent of the  $V_{DD}$  voltage, and there is a hysteresis voltage of approximately 0.4 V. These levels permit the inputs to be driven from a range of input logic signal levels for which a voltage over 2 V is considered logic HIGH. The driving signal for the TTL inputs should have fast rising and falling edges with a slew rate of 6 V/ $\mu$ s or faster, so the rise time from 0 to 3.3 V should be 550 ns or less. With reduced slew rate, circuit noise could cause the driver input voltage to exceed the hysteresis voltage and retrigger the driver input, causing erratic operation.

In the FAN3100C, the logic input thresholds are dependent on the  $V_{DD}$  level and, with  $V_{DD}$  of 12 V, the logic rising edge threshold is approximately 55% of  $V_{DD}$  and the input falling edge threshold is approximately 38% of  $V_{DD}$ . The CMOS input configuration offers a hysteresis voltage of approximately 17% of  $V_{DD}$ . The CMOS inputs can be used with relatively slow edges (approaching DC) if good decoupling and bypass techniques are incorporated in the system design to prevent noise from violating the input voltage hysteresis window. This allows setting precise timing intervals by fitting an R-C circuit between the controlling signal and the IN pin of the driver. The slow rising edge at the IN pin of the driver introduces a delay between the controlling signal and the OUT pin of the driver.

### Static Supply Current

In the  $I_{DD}$  (static) typical performance graphs (Figure 9 - Figure 10 and Figure 15 - Figure 16), the curve is produced with all inputs floating (OUT is LOW) and indicates the lowest static  $I_{DD}$  current for the tested configuration. For other states, additional current flows through the 100 k $\Omega$  resistors on the inputs and outputs shown in the block diagrams (see Figure 5 - Figure 6). In these cases, the actual static  $I_{DD}$  current is the value obtained from the curves plus this additional current.

### MillerDrive™ Gate Drive Technology

FAN3100 drivers incorporate the MillerDrive™ architecture shown in Figure 42 for the output stage, a combination of bipolar and MOS devices capable of providing large currents over a wide range of supply voltage and temperature variations. The bipolar devices carry the bulk of the current as OUT swings between 1/3 to 2/3  $V_{DD}$  and the MOS devices pull the output to the high or low rail.

The purpose of the MillerDrive™ architecture is to speed up switching by providing the highest current during the Miller plateau region when the gate-drain capacitance of the MOSFET is being charged or discharged as part of the turn-on / turn-off process. For applications that have zero voltage switching during the MOSFET turn-on or turn-off interval, the driver supplies high peak current for fast switching even though

the Miller plateau is not present. This situation often occurs in synchronous rectifier applications because the body diode is generally conducting before the MOSFET is switched on.

The output pin slew rate is determined by  $V_{DD}$  voltage and the load on the output. It is not user adjustable, but if a slower rise or fall time at the MOSFET gate is needed, a series resistor can be added.

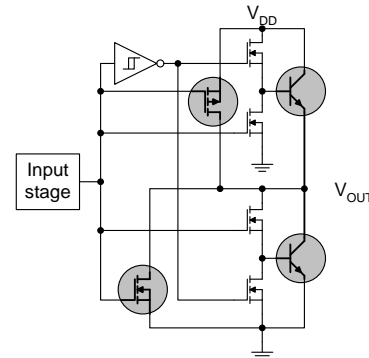

**Figure 42. MillerDrive™ Output Architecture Under-Voltage Lockout**

The FAN3100 start-up logic is optimized to drive ground referenced N-channel MOSFETs with a under-voltage lockout (UVLO) function to ensure that the IC starts up in an orderly fashion. When  $V_{DD}$  is rising, yet below the 3.9 V operational level, this circuit holds the output LOW, regardless of the status of the input pins. After the part is active, the supply voltage must drop 0.2 V before the part shuts down. This hysteresis helps prevent chatter when low  $V_{DD}$  supply voltages have noise from the power switching. This configuration is not suitable for driving high-side P-channel MOSFETs because the low output voltage of the driver would turn the P-channel MOSFET on with  $V_{DD}$  below 3.9 V.

### VDD Bypass Capacitor Guidelines

To enable this IC to turn a power device on quickly, a local, high-frequency, bypass capacitor  $C_{BYP}$  with low ESR and ESL should be connected between the VDD and GND pins with minimal trace length. This capacitor is in addition to bulk electrolytic capacitance of 10 $\mu$ F to 47 $\mu$ F often found on driver and controller bias circuits.

A typical criterion for choosing the value of  $C_{BYP}$  is to keep the ripple voltage on the  $V_{DD}$  supply  $\leq 5\%$ . Often this is achieved with a value  $\geq 20$  times the equivalent load capacitance  $C_{EQV}$ , defined here as  $Q_{gate}/V_{DD}$ . Ceramic capacitors of 0.1 $\mu$ F to 1 $\mu$ F or larger are common choices, as are dielectrics, such as X5R and X7R, which have good temperature characteristics and high pulse current capability.

If circuit noise affects normal operation, the value of  $C_{BYP}$  may be increased to 50-100 times the  $C_{EQV}$ , or  $C_{BYP}$  may be split into two capacitors. One should be a larger value, based on equivalent load capacitance, and the other a smaller value, such as 1-10 nF, mounted closest to the VDD and GND pins to carry the higher-frequency components of the current pulses.

## Layout and Connection Guidelines

The FAN3100 incorporates fast-reacting input circuits, short propagation delays, and powerful output stages capable of delivering current peaks over 2 A to facilitate voltage transition times from under 10 ns to over 100 ns. The following layout and connection guidelines are strongly recommended:

- Keep high-current output and power ground paths separate from logic input signals and signal ground paths. This is especially critical when dealing with TTL-level logic thresholds.
- Keep the driver as close to the load as possible to minimize the length of high-current traces. This reduces the series inductance to improve high-speed switching, while reducing the loop area that can radiate EMI to the driver inputs and other surrounding circuitry.
- The FAN3100 is available in two packages with slightly different pinouts, offering similar performance. In the 6-pin MLP package, Pin 2 is internally connected to the input analog ground and should be connected to power ground, Pin 5, through a short direct path underneath the IC. In the 5-pin SOT23, the internal analog and power ground connections are made through separate, individual bond wires to Pin 2, which should be used as the common ground point for power and control signals.
- Many high-speed power circuits can be susceptible to noise injected from their own output or other external sources, possibly causing output re-triggering. These effects can be especially obvious if the circuit is tested in breadboard or non-optimal circuit layouts with long input, enable, or output leads. For best results, make connections to all pins as short and direct as possible.
- The turn-on and turn-off current paths should be minimized as discussed in the following sections.

Figure 43 shows the pulsed gate drive current path when the gate driver is supplying gate charge to turn the MOSFET on. The current is supplied from the local bypass capacitor,  $C_{BYP}$ , and flows through the driver to the MOSFET gate and to ground. To reach the high peak currents possible, the resistance and inductance in the path should be minimized. The localized  $C_{BYP}$  acts to contain the high peak current pulses within this driver-MOSFET circuit, preventing them from disturbing the sensitive analog circuitry in the PWM controller.

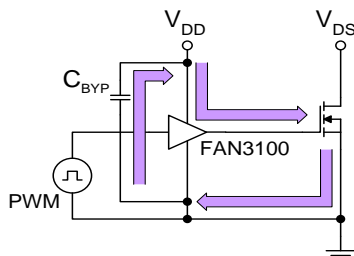

Figure 43. Current Path for MOSFET Turn-On

Figure 44 shows the current path when the gate driver turns the MOSFET off. Ideally, the driver shunts the current directly to the source of the MOSFET in a small circuit loop. For fast turn-off times, the resistance and inductance in this path should be minimized.

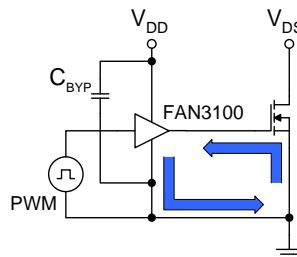

Figure 44. Current Path for MOSFET Turn-Off

## Truth Table of Logic Operation

The truth table indicates the operational states using the dual-input configuration. In a non-inverting driver configuration, the IN- pin should be a logic LOW signal. If the IN- pin is connected to logic HIGH, a disable function is realized, and the driver output remains LOW regardless of the state of the IN+ pin.

IN+	IN-	OUT
0	0	0
0	1	0
1	0	1
1	1	0

In the non-inverting driver configuration in Figure 45, the IN- pin is tied to ground and the input signal (PWM) is applied to IN+ pin. The IN- pin can be connected to logic HIGH to disable the driver and the output remains LOW, regardless of the state of the IN+ pin.

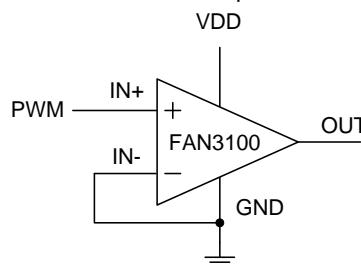

Figure 45. Dual-Input Driver Enabled, Non-Inverting Configuration

In the inverting driver application shown in Figure 46, the IN+ pin is tied HIGH. Pulling the IN+ pin to GND forces the output LOW, regardless of the state of the IN- pin.

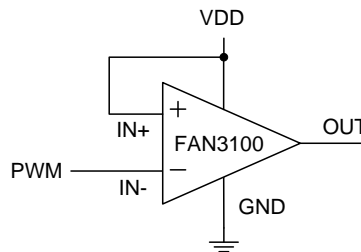
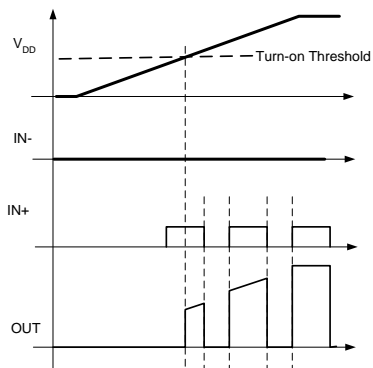

Figure 46. Dual-Input Driver Enabled, Inverting Configuration

## Operational Waveforms

At power up, the driver output remains LOW until the  $V_{DD}$  voltage reaches the turn-on threshold. The magnitude of the OUT pulses rises with  $V_{DD}$  until steady-state  $V_{DD}$  is reached. The non-inverting operation illustrated in Figure 47 shows that the output remains LOW until the UVLO threshold is reached, then the output is in-phase with the input.



**Figure 47. Non-Inverting Start-Up Waveforms**

For the inverting configuration of Figure 46, start-up waveforms are shown in Figure 48. With IN+ tied to  $V_{DD}$  and the input signal applied to IN-, the OUT pulses are inverted with respect to the input. At power up, the inverted output remains LOW until the  $V_{DD}$  voltage reaches the turn-on threshold, then it follows the input with inverted phase.

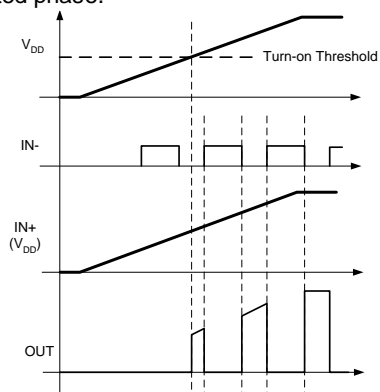

**Figure 48. Inverting Start-Up Waveforms**

## Thermal Guidelines

Gate drivers used to switch MOSFETs and IGBTs at high frequencies can dissipate significant amounts of power. It is important to determine the driver power dissipation and the resulting junction temperature in the application to ensure that the part is operating within acceptable temperature limits.

The total power dissipation in a gate driver is the sum of two components;  $P_{GATE}$  and  $P_{DYNAMIC}$ :

$$P_{TOTAL} = P_{GATE} + P_{DYNAMIC} \quad (1)$$

**Gate Driving Loss:** The most significant power loss results from supplying gate current (charge per unit time) to switch the load MOSFET on and off at the switching frequency. The power dissipation that results from driving a MOSFET at a specified gate-

source voltage,  $V_{GS}$ , with gate charge,  $Q_G$ , at switching frequency,  $f_{SW}$ , is determined by:

$$P_{GATE} = Q_G \cdot V_{GS} \cdot f_{SW} \quad (2)$$

**Dynamic Pre-drive / Shoot-through Current:** A power loss resulting from internal current consumption under dynamic operating conditions, including pin pull-up / pull-down resistors, can be obtained using the  $I_{DD}$  (no-Load) vs. Frequency graphs in Typical Performance Characteristics to determine the current  $I_{DYNAMIC}$  drawn from  $V_{DD}$  under actual operating conditions:

$$P_{DYNAMIC} = I_{DYNAMIC} \cdot V_{DD} \quad (3)$$

Once the power dissipated in the driver is determined, the driver junction rise with respect to circuit board can be evaluated using the following thermal equation, assuming  $\Psi_{JB}$  was determined for a similar thermal design (heat sinking and air flow):

$$T_J = P_{TOTAL} \cdot \Psi_{JB} + T_B \quad (4)$$

where:

$T_J$  = driver junction temperature

$\Psi_{JB}$  = (psi) thermal characterization parameter relating temperature rise to total power dissipation

$T_B$  = board temperature in location defined in the Thermal Characteristics table.

In a typical forward converter application with 48 V input, as shown in Figure 49, the FDS2672 would be a potential MOSFET selection. The typical gate charge would be 32 nC with  $V_{GS} = V_{DD} = 10$  V. Using a TTL input driver at a switching frequency of 500 kHz, the total power dissipation can be calculated as:

$$P_{GATE} = 32 \text{ nC} \cdot 10 \text{ V} \cdot 500 \text{ kHz} = 0.160 \text{ W} \quad (5)$$

$$P_{DYNAMIC} = 8 \text{ mA} \cdot 10 \text{ V} = 0.080 \text{ W} \quad (6)$$

$$P_{TOTAL} = 0.24 \text{ W} \quad (7)$$

The 5-pin SOT23 has a junction-to-lead thermal characterization parameter  $\Psi_{JB} = 51^\circ\text{C/W}$ .

In a system application, the localized temperature around the device is a function of the layout and construction of the PCB along with airflow across the surfaces. To ensure reliable operation, the maximum junction temperature of the device must be prevented from exceeding the maximum rating of  $150^\circ\text{C}$ ; with 80% derating,  $T_J$  would be limited to  $120^\circ\text{C}$ . Rearranging Equation 4 determines the board temperature required to maintain the junction temperature below  $120^\circ\text{C}$ :

$$T_{B,MAX} = T_J - P_{TOTAL} \cdot \Psi_{JB} \quad (8)$$

$$T_{B,MAX} = 120^\circ\text{C} - 0.24\text{W} \cdot 51^\circ\text{C/W} = 108^\circ\text{C} \quad (9)$$

For comparison purposes, replace the 5-pin SOT23 used in the previous example with the 6-pin MLP package with  $\Psi_{JB} = 2.8^\circ\text{C/W}$ . The 6-pin MLP package can operate at a PCB temperature of  $119^\circ\text{C}$ , while maintaining the junction temperature below  $120^\circ\text{C}$ . This illustrates that the physically smaller MLP package with thermal pad offers a more conductive path to remove the heat from the driver. Consider the tradeoffs between reducing overall circuit size with junction temperature reduction for increased reliability.



## Typical Application Diagrams

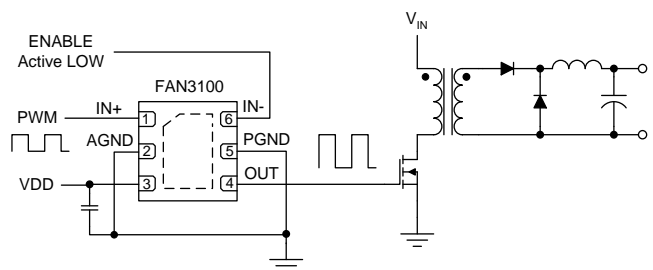

**Figure 49. Forward Converter, Primary-Side Gate Drive (MLP Package Show n)**

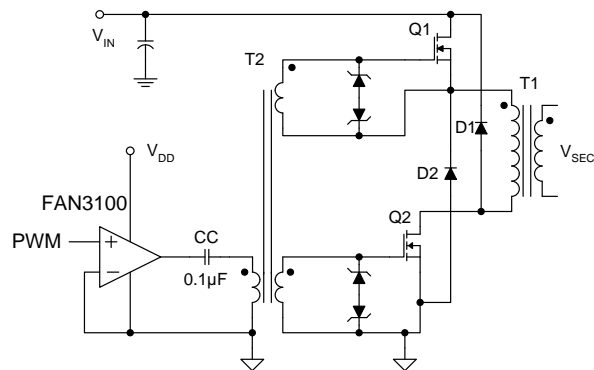

**Figure 50. Driver for Two-Transistor Forward Converter Gate Transformer**

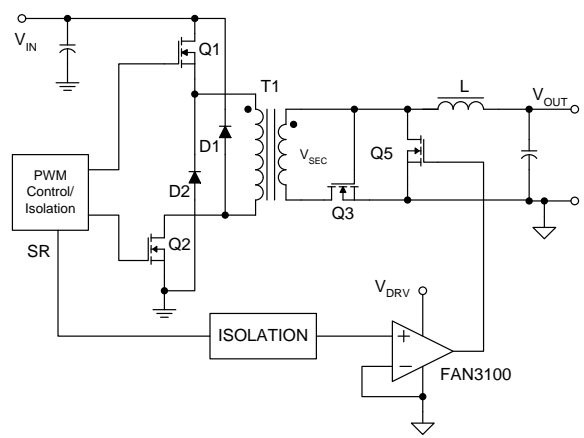

**Figure 51. Secondary Synchronous Rectifier Driver**

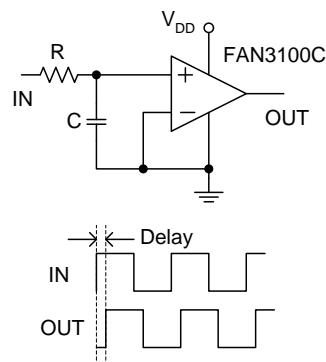

**Figure 52. Programmable Delay Using CMOS Input**

Table 1. Related Products

Part Number	Type	Gate Drive <sup>(11)</sup> (Sink/Src)	Input Threshold	Logic	Package
FAN3100C	Single 2 A	+2.5 A / -1.8A	CMOS	Single Channel of Two-Input/One-Output	SOT23-5, MLP6
FAN3100T	Single 2 A	+2.5 A / -1.8A	TTL	Single Channel of Two-Input/One-Output	SOT23-5, MLP6
FAN3226C	Dual 2 A	+2.4 A / -1.6 A	CMOS	Dual Inverting Channels + Dual Enable	SOIC8, MLP8
FAN3226T	Dual 2 A	+2.4 A / -1.6 A	TTL	Dual Inverting Channels + Dual Enable	SOIC8, MLP8
FAN3227C	Dual 2 A	+2.4 A / -1.6 A	CMOS	Dual Non-Inverting Channels + Dual Enable	SOIC8, MLP8
FAN3227T	Dual 2 A	+2.4 A / -1.6 A	TTL	Dual Non-Inverting Channels + Dual Enable	SOIC8, MLP8
FAN3228C	Dual 2 A	+2.4 A / -1.6 A	CMOS	Dual Channels of Two-Input/One-Output, Pin Config.1	SOIC8, MLP8
FAN3228T	Dual 2 A	+2.4 A / -1.6 A	TTL	Dual Channels of Two-Input/One-Output, Pin Config.1	SOIC8, MLP8
FAN3229C	Dual 2 A	+2.4 A / -1.6 A	CMOS	Dual Channels of Two-Input/One-Output, Pin Config.2	SOIC8, MLP8
FAN3229T	Dual 2 A	+2.4 A / -1.6 A	TTL	Dual Channels of Two-Input/One-Output, Pin Config.2	SOIC8, MLP8
FAN3223C	Dual 4 A	+4.3 A / -2.8 A	CMOS	Dual Inverting Channels + Dual Enable	SOIC8, MLP8
FAN3223T	Dual 4 A	+4.3 A / -2.8 A	TTL	Dual Inverting Channels + Dual Enable	SOIC8, MLP8
FAN3224C	Dual 4 A	+4.3 A / -2.8 A	CMOS	Dual Non-Inverting Channels + Dual Enable	SOIC8, MLP8
FAN3224T	Dual 4 A	+4.3 A / -2.8 A	TTL	Dual Non-Inverting Channels + Dual Enable	SOIC8, MLP8
FAN3225C	Dual 4 A	+4.3 A / -2.8 A	CMOS	Dual Channels of Two-Input/One-Output	SOIC8, MLP8
FAN3225T	Dual 4 A	+4.3 A / -2.8 A	TTL	Dual Channels of Two-Input/One-Output	SOIC8, MLP8

**Note:**11. Typical currents with OUT at 6 V and  $V_{DD} = 12$  V.

### Physical Dimensions

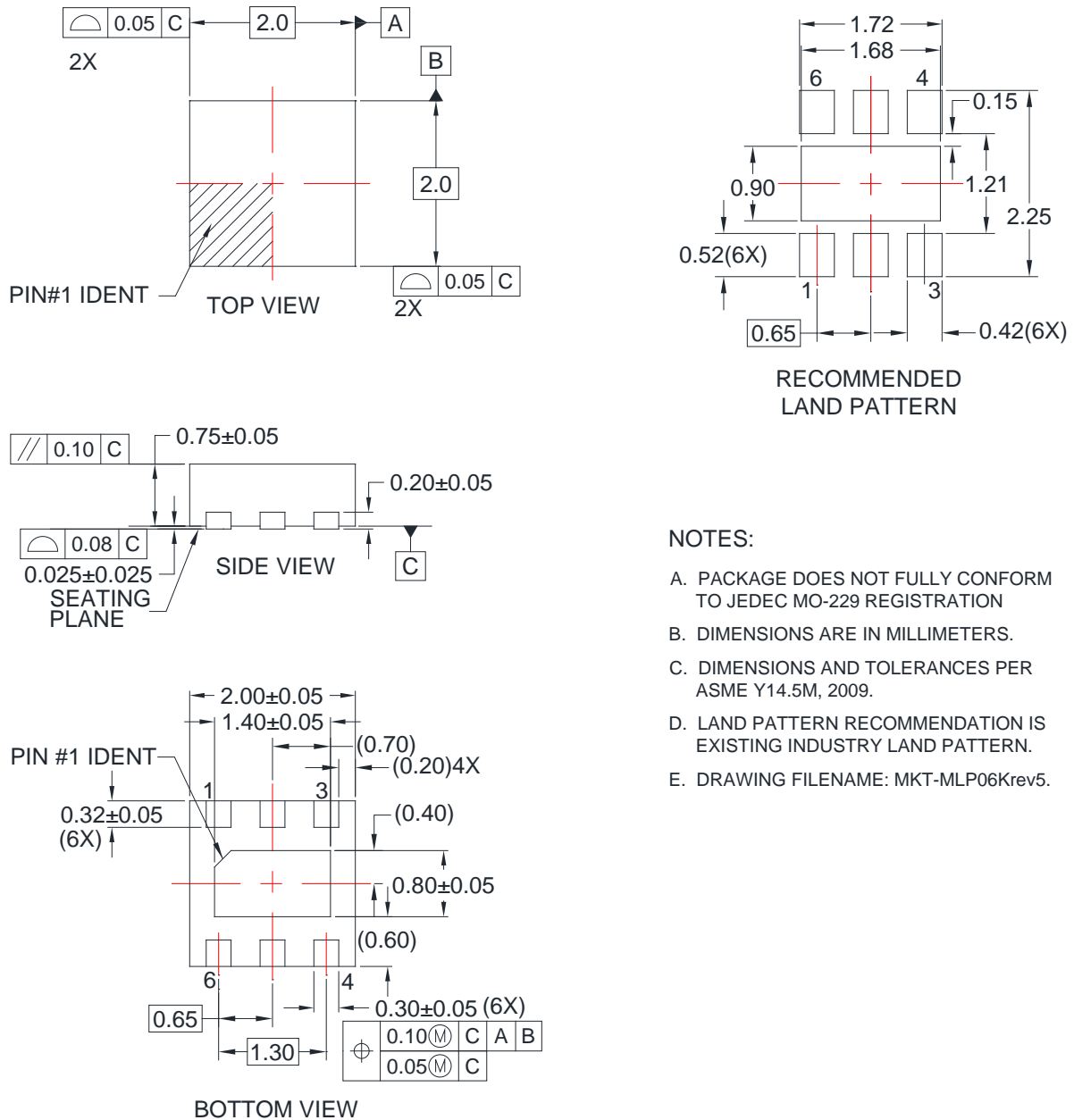

**Figure 53. 2x2 mm, 6-Lead, Molded Leadless Package (MLP)**

Package drawings are provided as a service to customers considering ON Semiconductor components. Drawings may change in any manner without notice. Please note the revision and/or date on the drawing and contact an ON Semiconductor representative to verify or obtain the most recent revision. Package specifications do not expand the terms of ON Semiconductor's worldwide terms and conditions, specifically the warranty therein, which covers ON Semiconductor products.

## Physical Dimensions

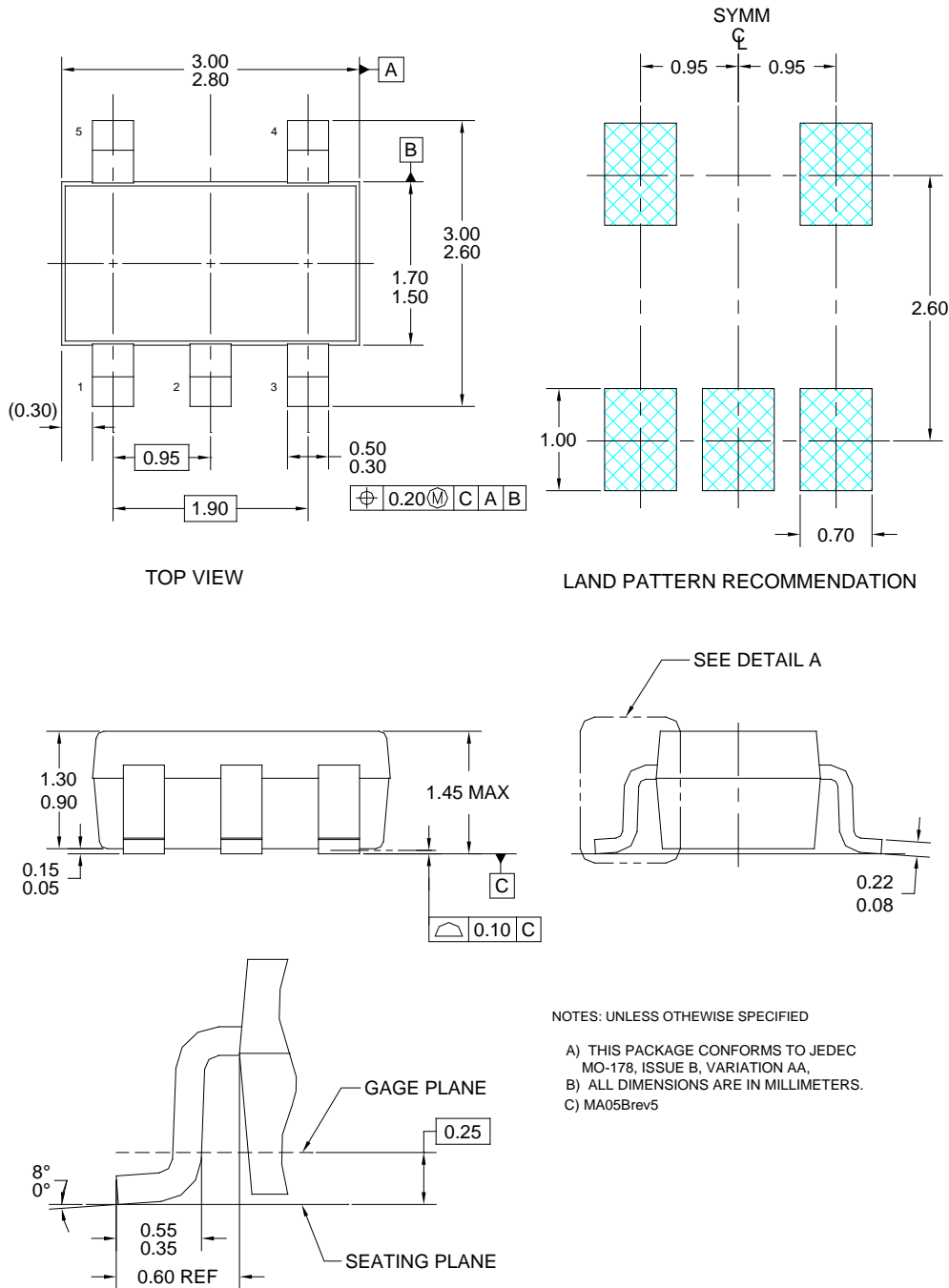

**Figure 54. 5-Lead SOT-23**

Package drawings are provided as a service to customers considering ON Semiconductor components. Drawings may change in any manner without notice. Please note the revision and/or date on the drawing and contact an ON Semiconductor representative to verify or obtain the most recent revision. Package specifications do not expand the terms of ON Semiconductor's worldwide terms and conditions, specifically the warranty therein, which covers ON Semiconductor products.

ON Semiconductor and the ON Semiconductor logo are trademarks of Semiconductor Components Industries, LLC dba ON Semiconductor or its subsidiaries in the United States and/or other countries. ON Semiconductor owns the rights to a number of patents, trademarks, copyrights, trade secrets, and other intellectual property. A listing of ON Semiconductor's product/patent coverage may be accessed at [www.onsemi.com/site/pdf/Patent-Marking.pdf](http://www.onsemi.com/site/pdf/Patent-Marking.pdf). ON Semiconductor reserves the right to make changes without further notice to any products herein. ON Semiconductor makes no warranty, representation or guarantee regarding the suitability of its products for any particular purpose, nor does ON Semiconductor assume any liability arising out of the application or use of any product or circuit, and specifically disclaims any and all liability, including without limitation special, consequential or incidental damages. Buyer is responsible for its products and applications using ON Semiconductor products, including compliance with all laws, regulations and safety requirements or standards, regardless of any support or applications information provided by ON Semiconductor. "Typical" parameters which may be provided in ON Semiconductor data sheets and/or specifications can and do vary in different applications and actual performance may vary over time. All operating parameters, including "Typicals" must be validated for each customer application by customer's technical experts. ON Semiconductor does not convey any license under its patent rights nor the rights of others. ON Semiconductor products are not designed, intended, or authorized for use as a critical component in life support systems or any FDA Class 3 medical devices or medical devices with a same or similar classification in a foreign jurisdiction or any devices intended for implantation in the human body. Should Buyer purchase or use ON Semiconductor products for any such unintended or unauthorized application, Buyer shall indemnify and hold ON Semiconductor and its officers, employees, subsidiaries, affiliates, and distributors harmless against all claims, costs, damages, and expenses, and reasonable attorney fees arising out of, directly or indirectly, any claim of personal injury or death associated with such unintended or unauthorized use, even if such claim alleges that ON Semiconductor was negligent regarding the design or manufacture of the part. ON Semiconductor is an Equal Opportunity/Affirmative Action Employer. This literature is subject to all applicable copyright laws and is not for resale in any manner.

## PUBLICATION ORDERING INFORMATION

### LITERATURE FULFILLMENT:

Literature Distribution Center for ON Semiconductor  
 19521 E. 32nd Pkwy, Aurora, Colorado 80011 USA  
**Phone:** 303-675-2175 or 800-344-3860 Toll Free  
 USA/Canada  
**Fax:** 303-675-2176 or 800-344-3867 Toll Free USA/Canada  
**Email:** [orderlit@onsemi.com](mailto:orderlit@onsemi.com)

**N. American Technical Support:** 800-282-9855 Toll Free  
 USA/Canada.  
**Europe, Middle East and Africa Technical Support:**  
 Phone: 421 33 790 2910  
**Japan Customer Focus Center**  
 Phone: 81-3-5817-1050

**ON Semiconductor Website:** [www.onsemi.com](http://www.onsemi.com)  
**Order Literature:** <http://www.onsemi.com/orderlit>  
 For additional information, please contact your local  
 Sales Representative