

MORNSUN®

VRA_ZP-6WR2 & VRB_ZP-6WR2 Series 6W, WIDE INPUT, ISOLATED & REGULATED DUAL/SINGLE OUTPUT DIP PACKAGING, DC-DC CONVERTER



Patent Protection RoHS CE

PART NUMBER SYSTEM

VRB2405ZP-6WR2

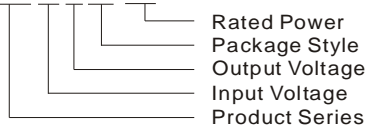

Rated Power
Package Style
Output Voltage
Input Voltage
Product Series

FEATURES

- 2:1 wide input voltage range
- Efficiency up to 89%
- 1.5KVDC isolation
- Short circuit protection
- Output over voltage protection
- Operation temperature range: -40°C ~ +85°C
- Industry standard pinout
- Low ripple & noise
- Meet CISPR22/EN55022 CLASS A
- Meet EN60950

APPLICATION

The VRA_ZP-6WR2 & VRB_ZP-6WR2 offer 6W of output, with wide input voltage of 9-18VDC, 18-36VDC, 36-75VDC and 1500VDC isolation voltage, output over-voltage protection and short-circuit protection. The products meet CISPR22/EN55022 CLASS A. All models are particularly suited to industrial control, electric power, instrumentation, tele-communications etc.

SELECTION GUIDE

Model	Input Voltage(VDC)		Output Voltage (VDC)	Output Current (mA)		Input Current (mA)(Typ.)		Reflected Ripple Current (mA, Typ.)	Max. Capacitive Load ^② (μF)	Efficiency (% , Typ.) @Max. Load	Approval
	Nominal (Range)	Max. ^①		Max.	Min.	@Max. Load	@No load				
VRA1205ZP-6WR2	12 (9-18)	20	±5	±600	±30	617	12	20	470	81	CE
VRA1212ZP-6WR2			±12	±250	±12	588			100	85	
VRA1215ZP-6WR2			±15	±200	±10	588			100	85	
VRB1203ZP-6WR2			3.3	1500	75	528			1800	76	
VRB1205ZP-6WR2			5	1200	60	617			1000	81	
VRB1212ZP-6WR2			12	500	25	588			100	85	
VRB1215ZP-6WR2			15	400	20	588			100	85	
VRB1224ZP-6WR2			24	250	12	574			47	87	
VRA2405ZP-6WR2	24 (18-36)	40	±5	±600	±30	301	9	20	470	83	CE
VRA2412ZP-6WR2			±12	±250	±12	287			100	87	
VRA2415ZP-6WR2			±15	±200	±10	287			100	87	
VRB2403ZP-6WR2			3.3	1500	75	261			1800	79	
VRB2405ZP-6WR2			5	1200	60	301			1000	83	
VRB2409ZP-6WR2			9	667	33	293			470	85	
VRB2412ZP-6WR2			12	500	25	287			100	87	
VRB2415ZP-6WR2			15	400	20	280			100	89	
VRB2424ZP-6WR2	24	250	13	283	47	88					
VRA4805ZP-6WR2	48 (36-75)	80	±5	±600	±30	150	3	20	470	83	CE
VRA4812ZP-6WR2			±12	±250	±12	143			100	87	
VRA4815ZP-6WR2			±15	±200	±10	142			100	88	
VRB4803ZP-6WR2			3.3	1500	75	130			1800	79	
VRB4805ZP-6WR2			5	1200	60	150			1000	83	
VRB4812ZP-6WR2			12	500	25	142			100	88	
VRB4815ZP-6WR2			15	400	20	142			100	88	

Note: ①. Input voltage can't exceed this value, or it will cause the permanent damage.

②. The capacitive load for both outputs is the same.

The copyright and authority for the interpretation of the products are reserved by MORNSUN

INPUT SPECIFICATIONS

Item	Test Conditions	Min.	Typ.	Max.	Unit
Input Surge Voltage (1sec. max.)	12V input	-0.7	--	25	VDC
Input Surge Voltage (1sec. max.)	24V input	-0.7	--	50	VDC
	48V input	-0.7	--	100	
Start-up Voltage	12V input	--	--	9	
	24V input	--	--	18	
	48V input	--	--	36	
Input Filter		Pi Filter			

OUTPUT SPECIFICATIONS

Item	Test Conditions	Min.	Typ.	Max.	Unit	
Output Voltage Accuracy	5% to 100% load	--	±1	±2	%	
Output Voltage Balance	Dual output, balance load	--	±0.5	±1.5		
Line Regulation	Full load, Input voltage from low to high	--	±0.2	±0.5		
Load Regulation	5% to 100% load	--	±0.5	±1		
Cross Regulation	Dual output, main output 50% load, Supplement output from 10% to 100% load	--	--	±5		
Transient Recovery Time	25% load step change	--	300	500		μs
Transient Response Deviation		--	±3	±5	%	
Temperature Drift	100% load	--	--	±0.03	%/°C	
Ripple & Noise*	20MHz bandwidth	3.3V, 5V output	--	30	80	mVp-p
		others	--	50	100	
Output Over Voltage Protection	Input voltage range	110	--	140	%Vo	
Output Short Circuit Protection		Continuous, automatic recovery				

Note:* Ripple and noise tested with "parallel cable" method. See detailed operation instructions at *DC-DC application notes*.

COMMON SPECIFICATIONS

Item	Test Conditions	Min.	Typ.	Max.	Unit
Isolation Voltage	Tested for 1 minute and leakage current less than 1 mA	1500	--	--	VDC
Isolation Resistance	Test at 500VDC	1000	--	--	MΩ
Isolation Capacitance	Input/Output, 100KHz/0.1V	--	1000	--	pF
Switching Frequency	5% to 100% load	--	300	--	KHz
MTBF	MIL-HDBK-217F @25°C	1000	--	--	K hours
Safety approvals		EN60950			
Case Material		Aluminum Alloy			
Weight		--	13	--	g

ENVIRONMENTAL SPECIFICATIONS

Item	Test Conditions	Min.	Typ.	Max.	Unit
Storage Humidity	Non condensing	5	--	95	%
Operating Temperature	Power derating (above 71°C, see Figure 4)	-40	--	85	°C
Storage Temperature		-55	--	125	
The Max. Case Temperature	Operating Temperature curve range	--	--	105	
Lead Temperature	1.5mm from case for 10 seconds	--	--	300	
Cooling		Free air convection			

EMC SPECIFICATIONS

EMI	CE	CISPR22/EN55022 CLASS A(Without External Circuit)/ CLASS B (External Circuit Refer to Figure 1-②or Figure 3)			
	RE	CISPR22/EN55022 CLASS A(Without External Circuit)/ CLASS B (External Circuit Refer to Figure 1-②or Figure 3)			
EMS	ESD	IEC/EN61000-4-2 Contact ±4KV		perf. Criteria B	

EMS	RS	IEC/EN61000-4-3	10V/m	perf. Criteria A
	EFT	IEC/EN61000-4-4	±2KV	perf. Criteria B (External Circuit Refer to Figure 1-①)
		IEC/EN61000-4-4	±4KV	perf. Criteria B (External Circuit Refer to Figure 3)
	Surge	IEC/EN61000-4-5	±2KV	perf. Criteria B (External Circuit Refer to Figure 1-①or Figure 3)
	CS	IEC/EN61000-4-6	3 Vr.m.s	perf. Criteria A
Voltage dips,short and interruptions immunity		IEC/EN61000-4-29	0%-70%	perf. Criteria B

EMC RECOMMENDED CIRCUIT

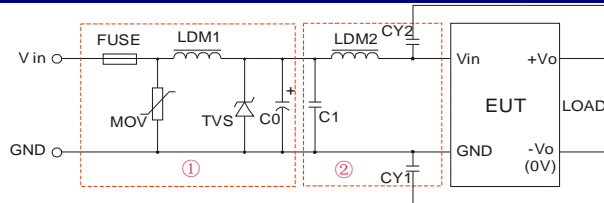

(Figure 1)

Parameters	Vin: 12V	Vin: 24V	Vin: 48V
FUSE	Choose according to practical input current		
MOV	--	S10K35	S10K60
LDM1	--	56μH	
TVS	SMCJ28A	SMCJ48A	SMCJ90A
C0	680μF/25V	120μF/50V	120μF/100V
C1	1μF/50V		1μF/100V
LDM2	4.7μH		
CY1	1nF/2000V		
CY2	1nF/2000V		

Note: 1. In Figure 1, part ① is EMS Recommended external circuit, part ② is EMI recommended external circuit. Choose according to requirements.
2. If there is no recommended parameters, the model no require the external component.

EMC RECOMMENDED CIRCUIT PCB LAYOUT

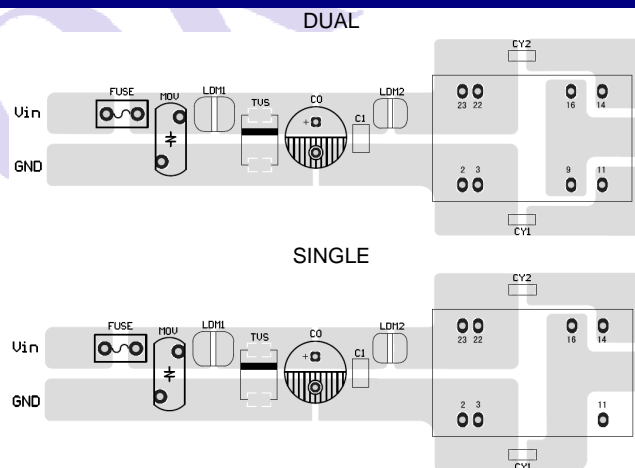

(Figure 2)

EMC MODULE RECOMMENDED CIRCUIT

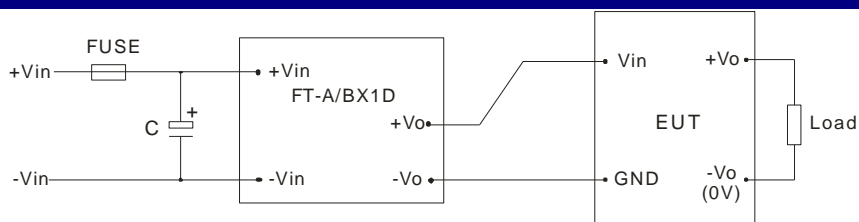

Nominal Voltage < 48V, C ≥ 330μF/50V
Nominal Voltage = 48V, C ≥ 330μF/100V
FT-A/BX1D is MORNSUN's EFT suppresser
(Figure 3)

EMI TEST WAVEFORM (NOMINAL AND FULL LOAD)

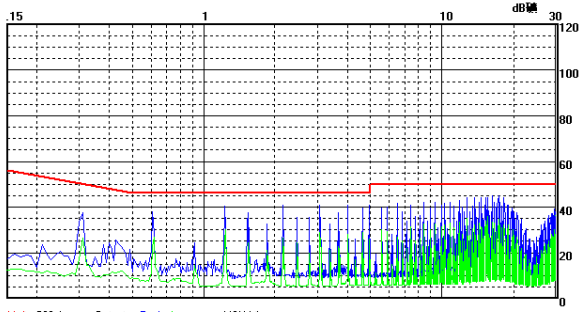

Limit: C22_b_av Detector: Peak, Average LISN L1
VRB2405ZP-6WR2 CE (Positive line)

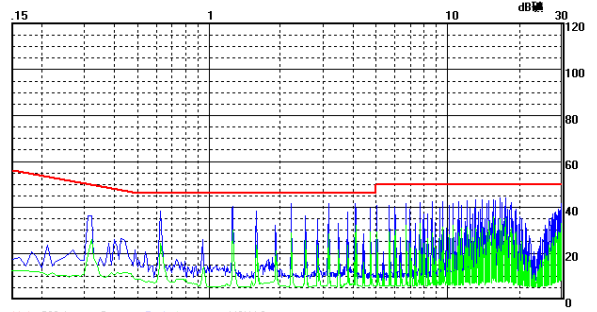

Limit: C22_b_av Detector: Peak, Average LISN L2
VRB2405ZP-6WR2 CE (Negative line)

PRODUCT TYPICAL CURVE

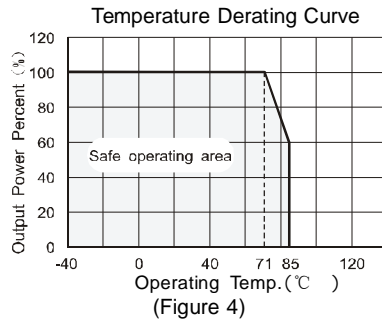

Efficiency VS Input Voltage curve (Full Load)

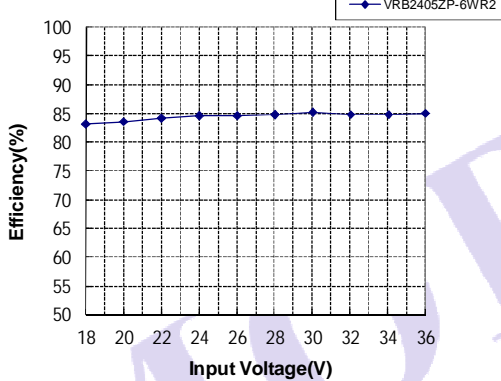

Efficiency VS Output Load curve (Vin=Vin-nominal)

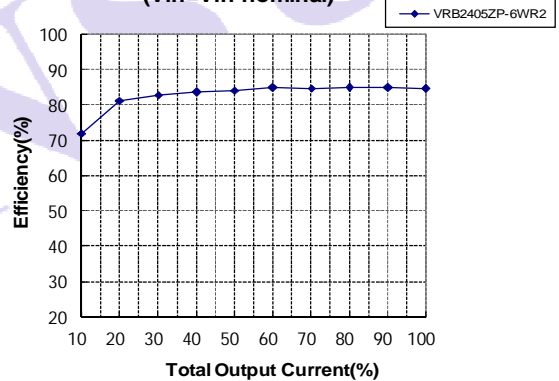

OUTLINE DIMENSIONS, RECOMMENDED FOOTPRINT & PACKAGING

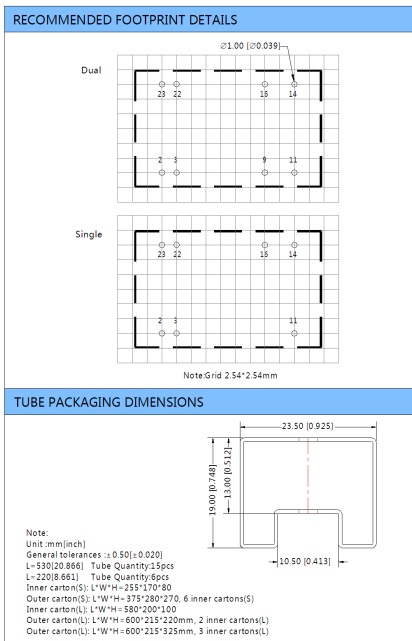
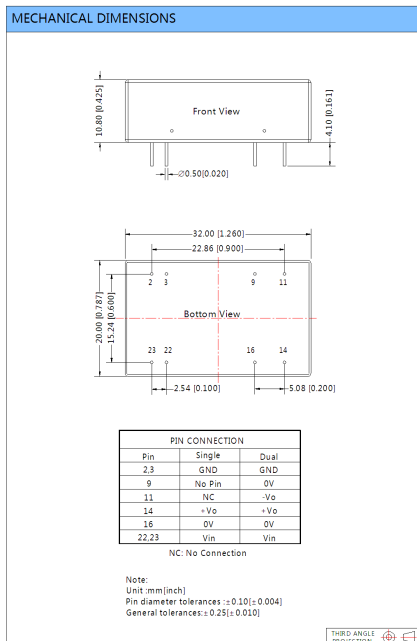

TEST CONFIGURATIONS

Input Reflected-Ripple Current Test Setup

Input reflected-ripple current is measured with an inductor L_{in} and Capacitor C_{in} to simulate source impedance.

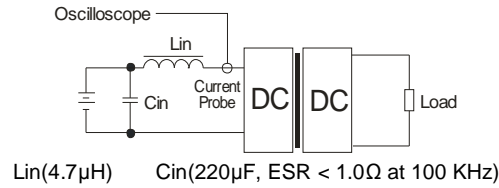

DESIGN CONSIDERATIONS

1) Recommended circuit

All the VRA_ZP-6WR2 & VRB_ZP-6WR2 Series have been tested according to the following recommended testing circuit before leaving factory (see Figure 5).

If you want to further decrease the output ripple, you can increase a capacitance properly or choose capacitors with low ESR, but the greatest capacitance of its filter capacitor must less than the Max. Capacitive Load.

Cin: 12V 100µF
24V&48V 10µF~47µF
Cout: 10µF

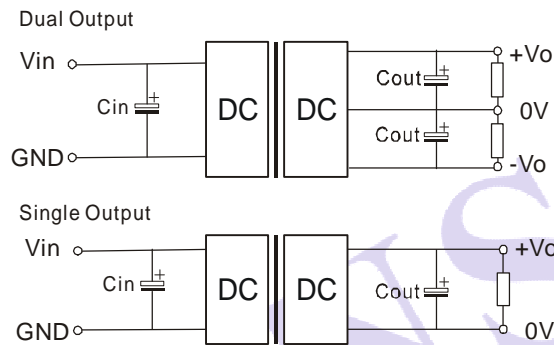

(Figure 5)

2) Cannot use in parallel and hot swap

Note:

1. Min. load shouldn't be less than 5%, otherwise ripple maybe increased dramatically, If the product operate under min. load, it may not be guaranteed to meet all specification listed. Operation under minimum load will not damage the converter.
2. Recommended Dual output models unbalanced load: $\leq \pm 5\%$, If the product operate $> \pm 5\%$, it may not be guaranteed to meet all specification Listed, please contact our technical person for more detail.
3. Max. Capacitive Load is tested at nominal input voltage and full load.
4. All specifications measured at $T_a=25^\circ\text{C}$, humidity<75%, nominal input voltage and rated output load unless otherwise specified.
5. In this datasheet, all the test methods of indications are based on our corporate standards.
6. All characteristics are for listed model, non-standard models may perform differently, please contact our technical person for more detail.
7. Contact us for your specific requirement.
8. Specifications of this product are subject to changes without prior notice.

MORNSUN Science & Technology Co.,Ltd.

Address: No. 5, Kehui St. 1, Kehui development center, Science Ave., Guangzhou Science City, Luogang district, Guangzhou,P.R.China.

Tel: 86-20-38601850

Fax:86-20-38601272

[Http://www.mornsun-power.com](http://www.mornsun-power.com)