

Ultra Fast NPT - IGBT®

The Ultra Fast NPT - IGBT® family of products is the newest generation of planar IGBTs optimized for outstanding ruggedness and the best trade-off between conduction and switching losses.

Features

- Low Saturation Voltage
- Low Tail Current
- RoHS Compliant 
- Short Circuit Withstand Rated
- High Frequency Switching
- Ultra Low Leakage Current



ISOTOP®
Combi (IGBT and Diode)



Unless stated otherwise, Microsemi discrete IGBTs contain a single IGBT die. This device is recommended for applications such as induction heating (IH), motor control, general purpose inverters and uninterruptible power supplies (UPS).

MAXIMUM RATINGS

All Ratings: $T_C = 25^\circ\text{C}$ unless otherwise specified.

Symbol	Parameter	Ratings	Unit
V_{ces}	Collector Emitter Voltage	1200	V
V_{GE}	Gate-Emitter Voltage	± 30	
I_{C1}	Continuous Collector Current @ $T_C = 25^\circ\text{C}$	84	A
I_{C2}	Continuous Collector Current @ $T_C = 90^\circ\text{C}$	50	
I_{CM}	Pulsed Collector Current ^①	200	
SCWT	Short Circuit Withstand Time: $V_{CE} = 600\text{V}$, $V_{GE} = 15\text{V}$, $T_C = 125^\circ\text{C}$	10	μs
P_D	Total Power Dissipation @ $T_C = 25^\circ\text{C}$	417	W
T_J, T_{STG}	Operating and Storage Junction Temperature Range	-55 to 150	$^\circ\text{C}$
T_L	Max. Lead Temp. for Soldering: 0.063" from Case for 10 Sec.	300	

STATIC ELECTRICAL CHARACTERISTICS

Symbol	Parameter	Min	Typ	Max	Unit
$V_{(BR)CES}$	Collector-Emitter Breakdown Voltage ($V_{GE} = 0\text{V}$, $I_C = 1.1\text{mA}$)	1200			Volts
$V_{GE(TH)}$	Gate Threshold Voltage ($V_{CE} = V_{GE}$, $I_C = 2.5\text{mA}$, $T_J = 25^\circ\text{C}$)	3.5	5.0	6.5	
$V_{CE(ON)}$	Collector-Emitter On Voltage ($V_{GE} = 15\text{V}$, $I_C = 50\text{A}$, $T_J = 25^\circ\text{C}$)		2.5	3.2	
	Collector-Emitter On Voltage ($V_{GE} = 15\text{V}$, $I_C = 50\text{A}$, $T_J = 125^\circ\text{C}$)		3.3		
	Collector-Emitter On Voltage ($V_{GE} = 15\text{V}$, $I_C = 100\text{A}$, $T_J = 25^\circ\text{C}$)		3.5		
I_{CES}	Collector Cut-off Current ($V_{CE} = 1200\text{V}$, $V_{GE} = 0\text{V}$, $T_J = 25^\circ\text{C}$) ^②		20	1100	μA
	Collector Cut-off Current ($V_{CE} = 1200\text{V}$, $V_{GE} = 0\text{V}$, $T_J = 125^\circ\text{C}$) ^②		200		
I_{GES}	Gate-Emitter Leakage Current ($V_{GE} = \pm 20\text{V}$)			± 250	nA



CAUTION: These Devices are Sensitive to Electrostatic Discharge. Proper Handling Procedures Should Be Followed.

DYNAMIC CHARACTERISTICS

APT50GR120JD30

Symbol	Parameter	Test Conditions	Min	Typ	Max	Unit
C_{ies}	Input Capacitance	Capacitance $V_{GE} = 0V, V_{CE} = 25V$ $f = 1MHz$		5550		pF
C_{oes}	Output Capacitance			500		
C_{res}	Reverse Transfer Capacitance			145		
V_{GEP}	Gate to Emitter Plateau Voltage	Gate Charge $V_{GE} = 15V$ $V_{CE} = 600V$ $I_C = 50A$		7.5		V
$Q_g^{(3)}$	Total Gate Charge			330	445	
Q_{ge}	Gate-Emitter Charge			52	72	
Q_{gc}	Gate- Collector Charge			156	200	
$t_{d(on)}$	Turn-On Delay Time	Inductive Switching (25°C) $V_{CC} = 600V$ $V_{GE} = 15V$ $I_C = 50A$ $R_G = 4.3 \Omega^{(4)}$ $T_J = +25^\circ C$		28		ns
t_r	Current Rise Time			38		
$t_{d(off)}$	Turn-Off Delay Time			237		
t_f	Current Fall Time			45		
$E_{on2}^{(5)}$	Turn-On Switching Energy	Inductive Switching (25°C) $R_G = 4.3 \Omega^{(4)}$ $T_J = +25^\circ C$		2135	3200	μJ
$E_{off}^{(6)}$	Turn-Off Switching Energy			1478	2210	
$t_{d(on)}$	Turn-On Delay Time	Inductive Switching (125°C) $V_{CC} = 600V$ $V_{GE} = 15V$ $I_C = 50A$ $R_G = 4.3 \Omega^{(4)}$ $T_J = +125^\circ C$		28		ns
t_r	Current Rise Time			38		
$t_{d(off)}$	Turn-Off Delay Time			270		
t_f	Current Fall Time			54		
$E_{on2}^{(5)}$	Turn-On Switching Energy	Inductive Switching (125°C) $R_G = 4.3 \Omega^{(4)}$ $T_J = +125^\circ C$		3157	4765	μJ
$E_{off}^{(6)}$	Turn-Off Switching Energy			1884	2820	

THERMAL AND MECHANICAL CHARACTERISTICS

Symbol	Characteristic	Min	Typ	Max	Unit
$R_{\theta JC}$	Junction to Case Thermal Resistance (IGBT)			.30	$^\circ C/W$
	Junction to Case Thermal Resistance (Diode)			1.1	
$V_{isolation}$	RMS Voltage (50-60Hz Sinusoidal Waveform From Terminals to Mounting Base for 1 Min.)	2500			
W_T	Package Weight		1.03		oz
			29.2		g
Torque	Maximum Mounting Torque			10	lb•in
				1.1	N•m

- 1 Repetitive Rating: Pulse width and case temperature limited by maximum junction temperature.
 - 2 Pulse test: Pulse Width < 380μs, duty cycle < 2%.
 - 3 See Mil-Std-750 Method 3471.
 - 4 R_G is external gate resistance, not including internal gate resistance or gate driver impedance. (MIC4452)
 - 5 E_{on2} is the energy loss at turn-on and includes the charge stored in the freewheeling diode.
 - 6 E_{off} is the clamped inductive turn-off energy measured in accordance with JEDEC standard JESD24-1.
- Microsemi reserves the right to change, without notice, the specifications and information contained herein.

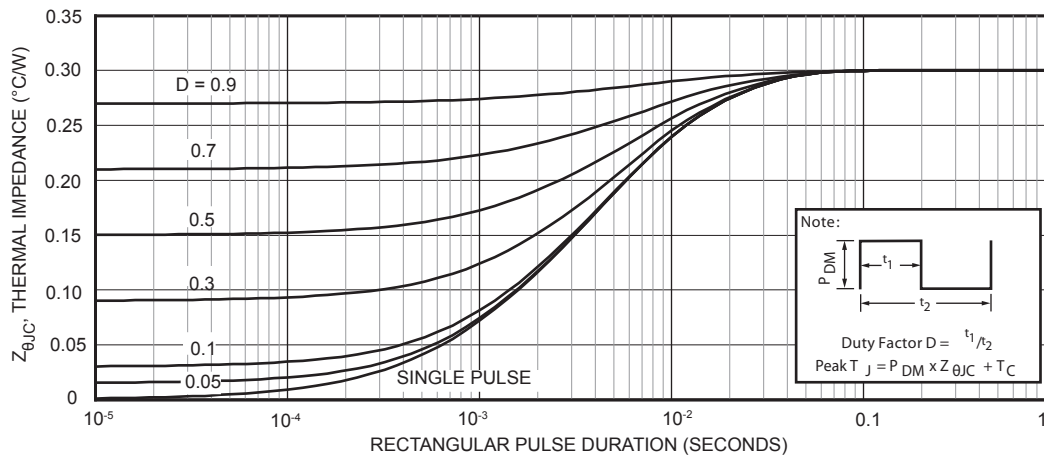

Figure 1, Maximum Effective Transient Thermal Impedance, Junction-To-Case vs Pulse Duration

TYPICAL PERFORMANCE CURVES

APT50GR120JD30

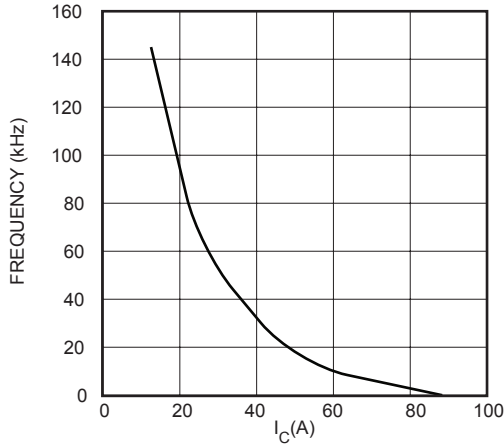

FIGURE 2, Max Frequency vs Current ($T_{case} = 75^{\circ}C$)

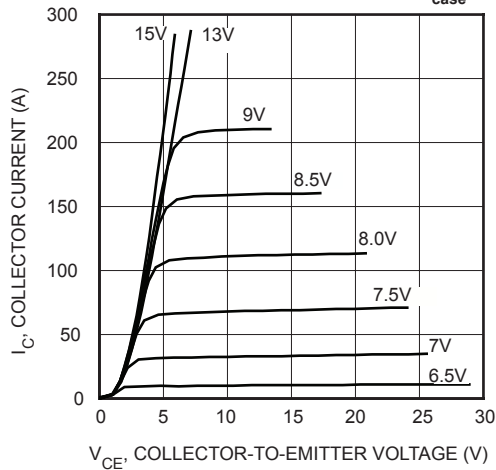

FIGURE 4, Output Characteristics ($T_J = 25^{\circ}C$)

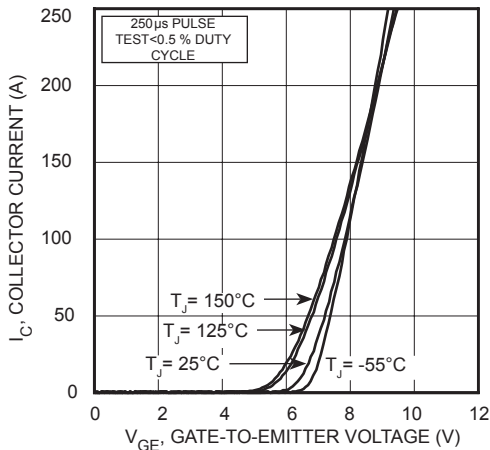

FIGURE 6, Transfer Characteristics

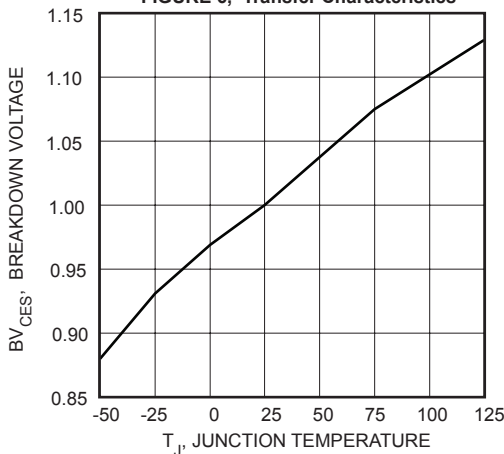

FIGURE 8, Breakdown Voltage vs Junction Temperature

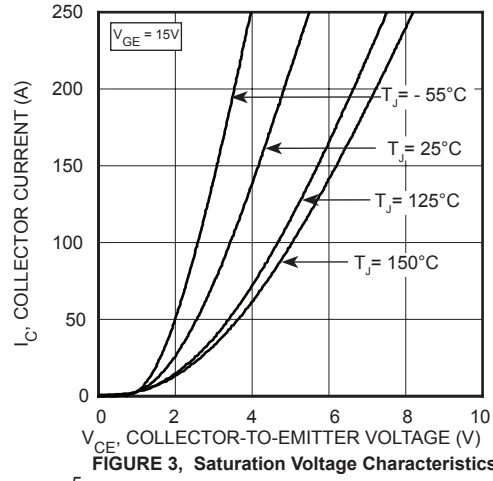

FIGURE 3, Saturation Voltage Characteristics

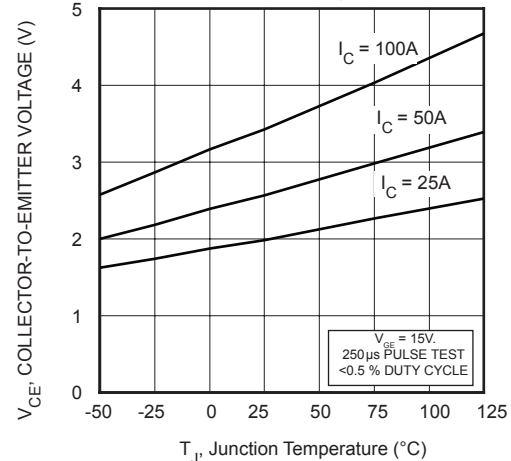

FIGURE 5, On State Voltage vs Junction Temperature

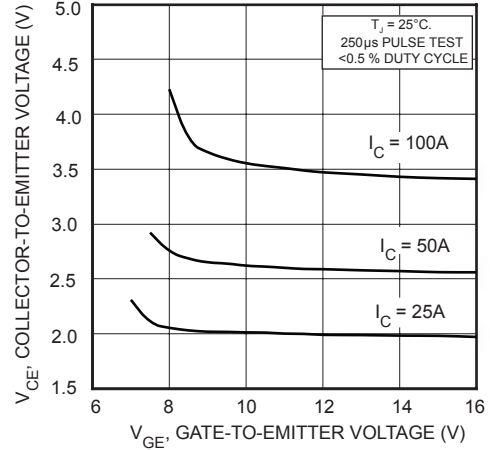

FIGURE 7, On State Voltage vs Gate-to-Emitter Voltage

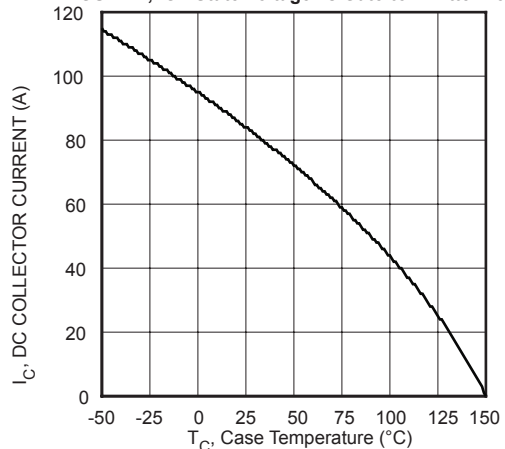

FIGURE 9, DC Collector Current vs Case Temperature

TYPICAL PERFORMANCE CURVES

APT50GR120JD30

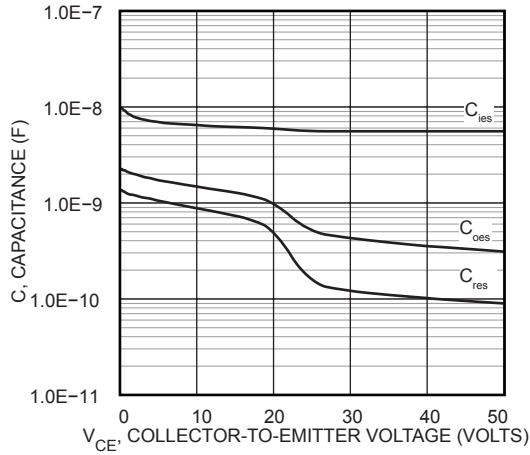

FIGURE 10, Capacitance vs Collector-To-Emitter Voltage

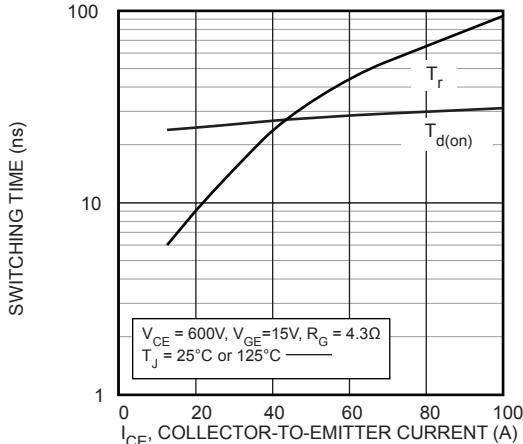

FIGURE 12, Turn-On Time vs Collector Current

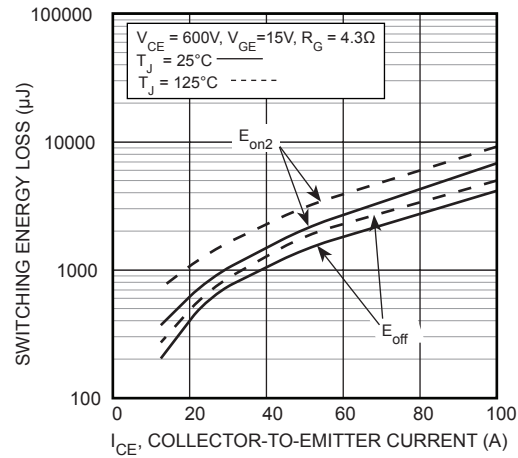

FIGURE 14, Energy Loss vs Collector Current

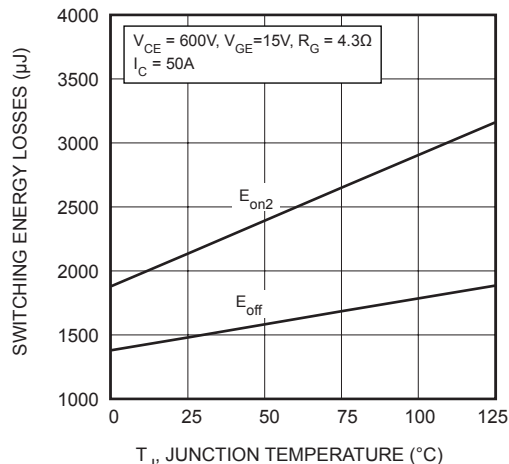

FIGURE 16, Switching Energy vs Junction Temperature

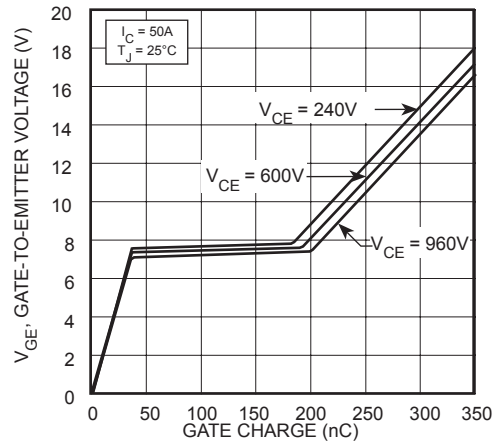

FIGURE 11, Gate charge

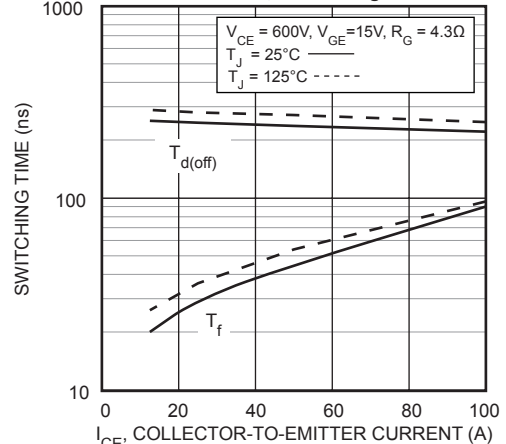

FIGURE 13, Turn-Off Time vs Collector Current

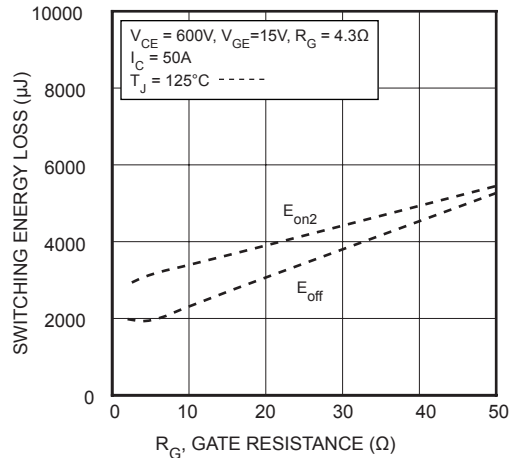

FIGURE 15, Energy Loss vs Gate Resistance

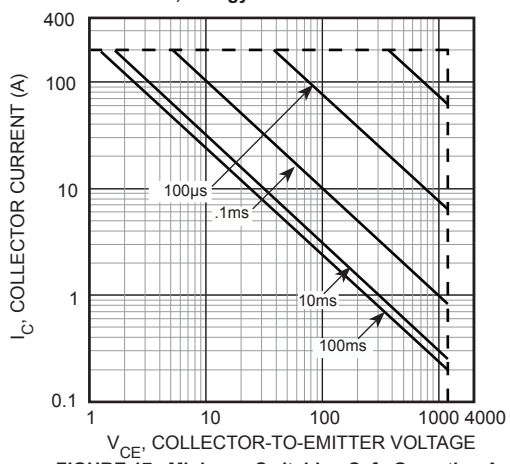

FIGURE 17, Minimum Switching Safe Operating Area

ULTRAFAST SOFT RECOVERY RECTIFIER DIODE

MAXIMUM RATINGS

All Ratings: $T_C = 25^\circ\text{C}$ unless otherwise specified.

Symbol	Characteristic / Test Conditions	APT50GR120JD30	Unit
$I_{F(AV)}$	Maximum Average Forward Current ($T_C = 92^\circ\text{C}$, Duty Cycle = 0.5)	30	Amps
$I_{F(RMS)}$	RMS Forward Current (Square wave, 50% duty)	39	
I_{FSM}	Non-Repetitive Forward Surge Current ($T_J = 45^\circ\text{C}$, 8.3 ms)	210	

STATIC ELECTRICAL CHARACTERISTICS

Symbol	Characteristic / Test Conditions	Min	Type	Max	Unit
V_F	Forward Voltage		$I_F = 30\text{A}$	2.6	Volts
			$I_F = 60\text{A}$	3.25	
			$I_F = 30\text{A}, T_J = 125^\circ\text{C}$	1.8	

DYNAMIC CHARACTERISTICS

Symbol	Characteristic	Test Conditions	Min	Typ	Max	Unit
t_{rr}	Reverse Recovery Time	$I_F = 1\text{A}, di_F/dt = -100\text{A}/\mu\text{s}, V_R = 30\text{V}, T_J = 25^\circ\text{C}$	-	25	-	ns
t_{rr}	Reverse Recovery Time	$I_F = 30\text{A}, di_F/dt = -200\text{A}/\mu\text{s}, V_R = 800\text{V}, T_C = 25^\circ\text{C}$	-	300	-	ns
Q_{rr}	Reverse Recovery Charge		-	360	-	
I_{RRM}	Maximum Reverse Recovery Current		-	4	-	
t_{rr}	Reverse Recovery Time	$I_F = 30\text{A}, di_F/dt = -200\text{A}/\mu\text{s}, V_R = 800\text{V}, T_C = 125^\circ\text{C}$	-	380	-	ns
Q_{rr}	Reverse Recovery Charge		-	1700	-	
I_{RRM}	Maximum Reverse Recovery Current		-	8	-	
t_{rr}	Reverse Recovery Time	$I_F = 60\text{A}, di_F/dt = -1000\text{A}/\mu\text{s}, V_R = 800\text{V}, T_C = 125^\circ\text{C}$	-	160	-	ns
Q_{rr}	Reverse Recovery Charge		-	2550	-	
I_{RRM}	Maximum Reverse Recovery Current		-	28	-	

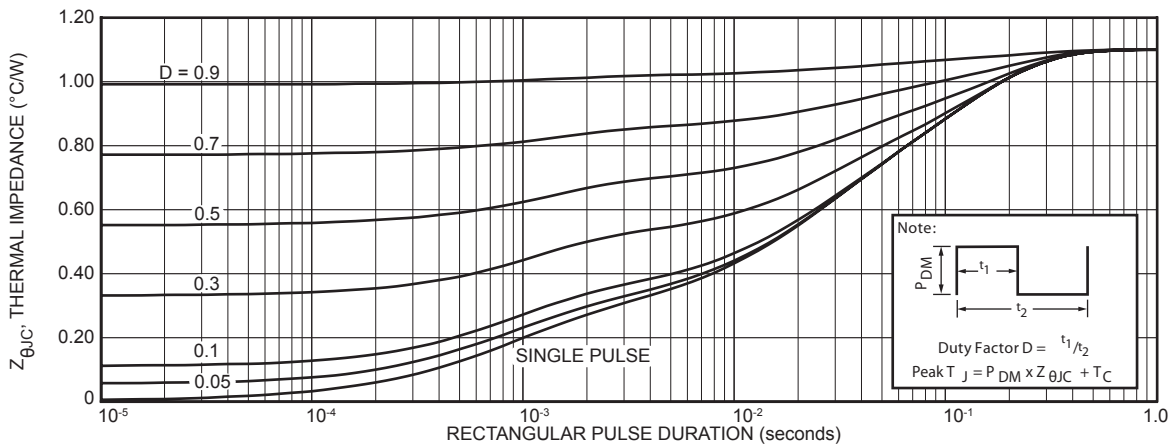

FIGURE 18. MAXIMUM EFFECTIVE TRANSIENT THERMAL IMPEDANCE, JUNCTION-TO-CASE vs. PULSE DURATION

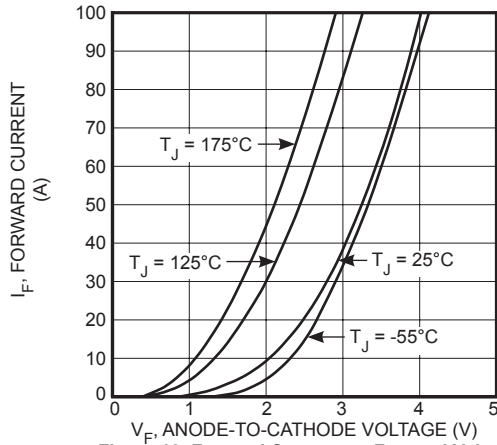

Figure 19. Forward Current vs. Forward Voltage

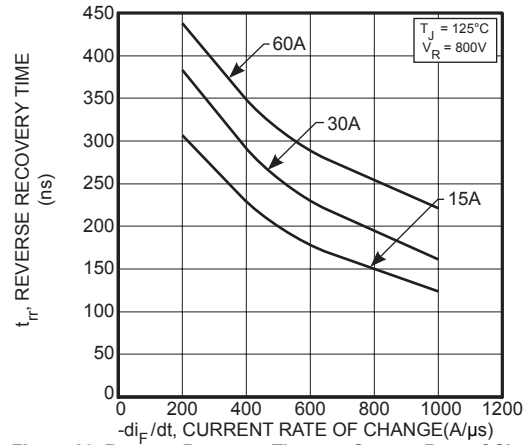

Figure 20. Reverse Recovery Time vs. Current Rate of Change

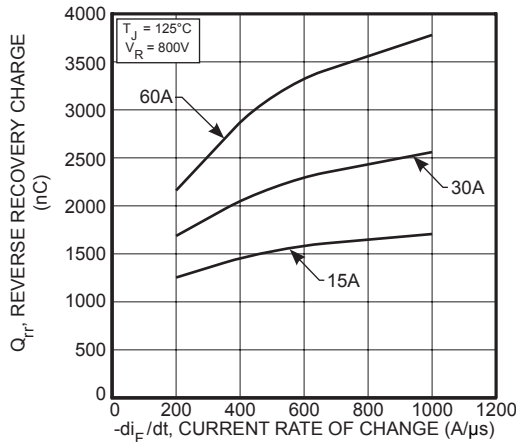

Figure 21. Reverse Recovery Charge vs. Current Rate of Change

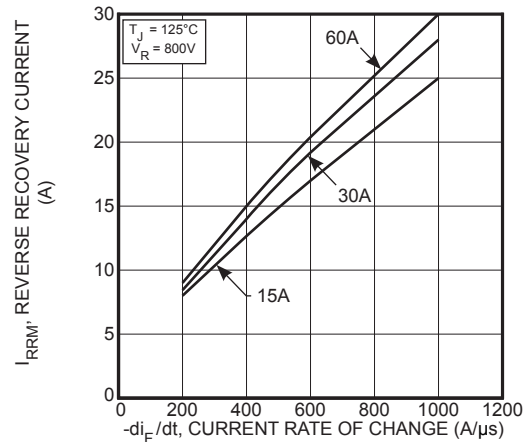

Figure 22. Reverse Recovery Current vs. Current Rate of Change

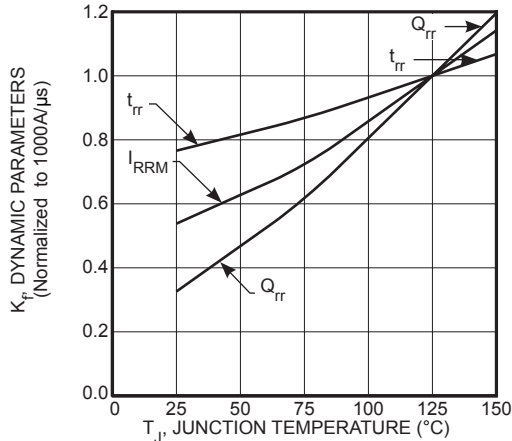

Figure 23. Dynamic Parameters vs. Junction Temperature

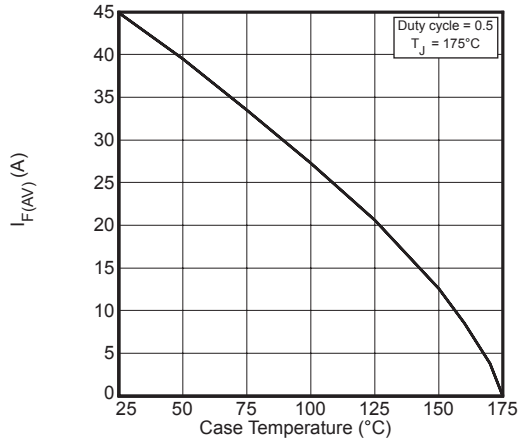

Figure 24. Maximum Average Forward Current vs. Case Temperature

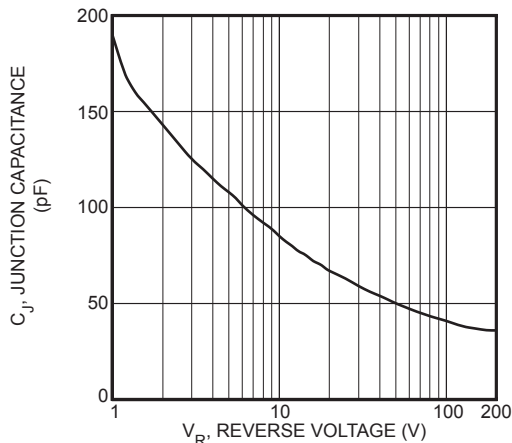

Figure 25. Junction Capacitance vs. Reverse Voltage

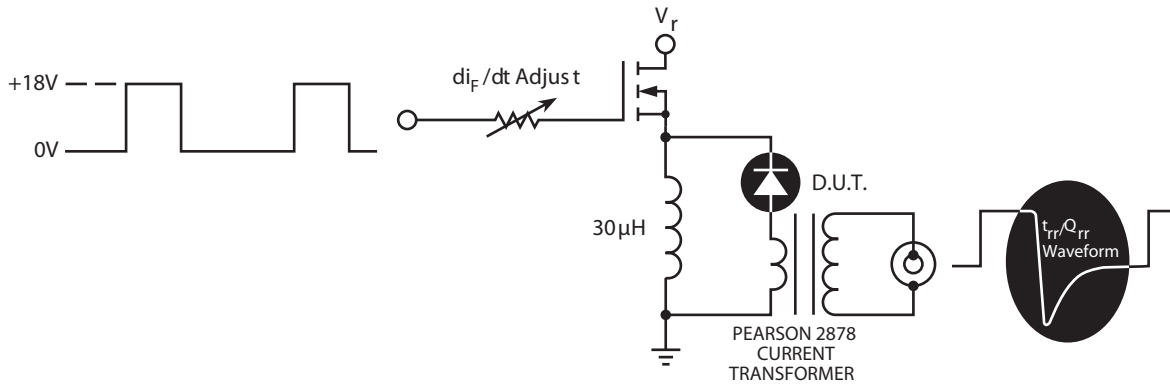

Figure 26. Diode Test Circuit

- 1 I_F - Forward Conduction Current
- 2 di_F/dt - Rate of Diode Current Change Through Zero Crossing.
- 3 I_{RRM} - Maximum Reverse Recovery Current
- 4 t_{rr} - Reverse Recovery Time measured from zero crossing where diode current goes from positive to negative, to the point at which the straight line through I_{RRM} and $0.25 I_{RRM}$ passes through zero.
- 5 Q_{rr} - Area Under the Curve Defined by I_{RRM} and t_{rr} .

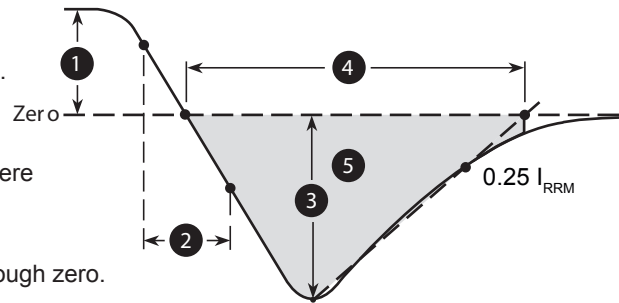
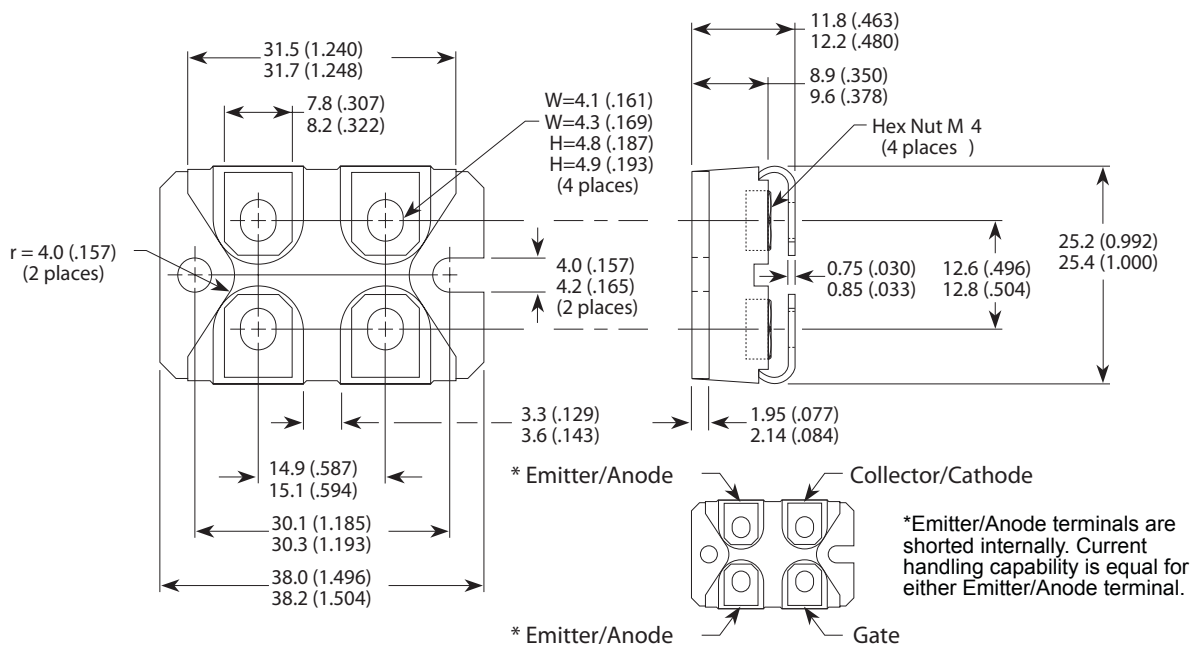

Figure 27. Diode Reverse Recovery Waveform Definition

SOT-227 (ISOTOP®) Package Outline



Dimensions in Millimeters and (Inches)

The information contained in the document (unless it is publicly available on the Web without access restrictions) is PROPRIETARY AND CONFIDENTIAL information of Microsemi and cannot be copied, published, uploaded, posted, transmitted, distributed or disclosed or used without the express duly signed written consent of Microsemi. If the recipient of this document has entered into a disclosure agreement with Microsemi, then the terms of such Agreement will also apply. This document and the information contained herein may not be modified, by any person other than authorized personnel of Microsemi. No license under any patent, copyright, trade secret or other intellectual property right is granted to or conferred upon you by disclosure or delivery of the information, either expressly, by implication, inducement, estoppels or otherwise. Any license under such intellectual property rights must be approved by Microsemi in writing signed by an officer of Microsemi.

Microsemi reserves the right to change the configuration, functionality and performance of its products at anytime without any notice. This product has been subject to limited testing and should not be used in conjunction with life-support or other mission-critical equipment or applications. Microsemi assumes no liability whatsoever, and Microsemi disclaims any express or implied warranty, relating to sale and/or use of Microsemi products including liability or warranties relating to fitness for a particular purpose, merchantability, or infringement of any patent, copyright or other intellectual property right. Any performance specifications believed to be reliable but are not verified and customer or user must conduct and complete all performance and other testing of this product as well as any user or customers final application. User or customer shall not rely on any data and performance specifications or parameters provided by Microsemi. It is the customer's and user's responsibility to independently determine suitability of any Microsemi product and to test and verify the same. The information contained herein is provided "AS IS, WHERE IS" and with all faults, and the entire risk associated with such information is entirely with the User. Microsemi specifically disclaims any liability of any kind including for consequential, incidental and punitive damages as well as lost profit. The product is subject to other terms and conditions which can be located on the web at <http://www.microsemi.com/legal/tnc.asp>