

## General Description

KEC NPT IGBTs offer low switching losses, high energy efficiency and high avalanche ruggedness for soft switching application such as IH(induction heating), microwave oven, etc.

## FEATURES

- High speed switching
- High system efficiency
- Soft current turn-off waveforms
- Extremely enhanced avalanche capability

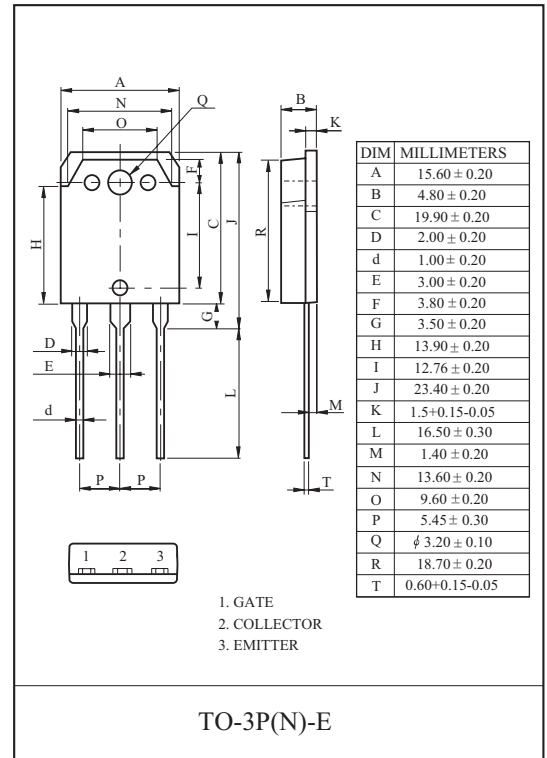

## MAXIMUM RATING (Ta=25°C)

CHARACTERISTIC	SYMBOL	RATING	UNIT
Collector-Emitter Voltage	$V_{CES}$	1200	V
Gate-Emitter Voltage	$V_{GES}$	± 20	V
Collector Current	$I_C$	@Tc=25°C	50
		@Tc=100°C	25
Pulsed Collector Current	$I_{CM}^*$	90	A
Diode Continuous Forward Current	@Tc=100°C	$I_F$	25
Diode Maximum Forward Current	$I_{FM}$	150	A
Maximum Power Dissipation	$P_D$	@Tc=25°C	310
		@Tc=100°C	125
Maximum Junction Temperature	$T_j$	150	°C
Storage Temperature Range	$T_{stg}$	-55 to + 150	°C

\*Repetitive rating : Pulse width limited by max. junction temperature

## THERMAL CHARACTERISTIC

CHARACTERISTIC	SYMBOL	MAX.	UNIT
Thermal Resistance, Junction to Case (IGBT)	$R_{\theta JC}$	0.4	°C/W
Thermal Resistance, Junction to Case (DIODE)	$R_{\theta JC}$	2.8	°C/W
Thermal Resistance, Junction to Ambient	$R_{\theta JA}$	40	°C/W

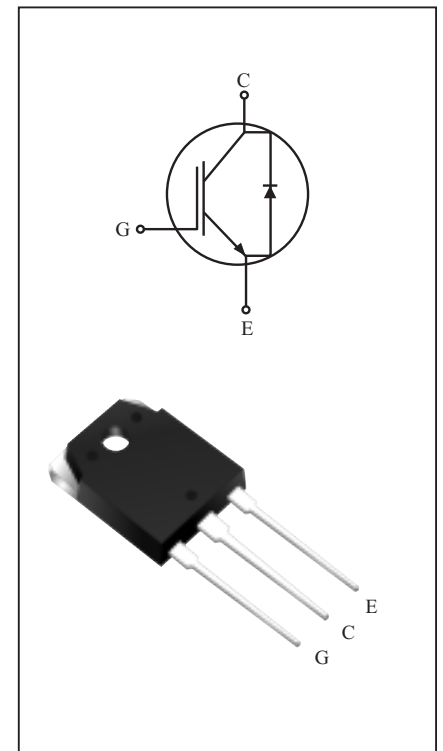

# KGT25N120NDA

## ELECTRICAL CHARACTERISTICS (Ta=25°C)

CHARACTERISTIC	SYMBOL	TEST CONDITION	MIN.	TYP.	MAX.	UNIT	
<b>Static</b>							
Collector-Emitter Breakdown Voltage	$BV_{CES}$	$V_{GE}=0V, I_C=1mA$	1200	-	-	V	
Collector Cut-off Current	$I_{CES}$	$V_{GE}=0V, V_{CE}=1200V$	-	-	1.0	mA	
Gate Leakage Current	$I_{GES}$	$V_{CE}=0V, V_{GE}=\pm 20V$	-	-	$\pm 100$	nA	
Gate Threshold Voltage	$V_{GE(th)}$	$V_{GE}=V_{CE}, I_C=25mA$	4.0	5.5	7.0	V	
Collector-Emitter Saturation Voltage	$V_{CE(sat)}$	$V_{GE}=15V, I_C=25A$	-	1.95	2.30	V	
		$V_{GE}=15V, I_C=25A, T_C = 125^\circ C$	-	2.25	-	V	
		$V_{GE}=15V, I_C=50A$	-	2.50	-	V	
<b>Dynamic</b>							
Total Gate Charge	$Q_g$	$V_{CC}=600V, V_{GE}=15V, I_C=25A$	-	200	300	nC	
Gate-Emitter Charge	$Q_{ge}$		-	20	-	nC	
Gate-Collector Charge	$Q_{gc}$		-	80	-	nC	
Turn-On Delay Time	$t_{d(on)}$	$V_{CC}=600V, I_C=25A, V_{GE}=15V, R_G=10\Omega$ Inductive Load, $T_C = 25^\circ C$	-	60	-	ns	
Rise Time	$t_r$		-	50	-	ns	
Turn-Off Delay Time	$t_{d(off)}$		-	290	-	ns	
Fall Time	$t_f$		-	100	-	ns	
Turn-On Switching Loss	$E_{on}$		-	4.1	6.1	mJ	
Turn-Off Switching Loss	$E_{off}$		-	0.86	1.4	mJ	
Total Switching Loss	$E_{ts}$		-	4.96	7.5	mJ	
Turn-On Delay Time	$t_{d(on)}$		$V_{CC}=600V, I_C=25A, V_{GE}=15V, R_G=10\Omega$ Inductive Load, $T_C = 125^\circ C$	-	60	-	ns
Rise Time	$t_r$			-	50	-	ns
Turn-Off Delay Time	$t_{d(off)}$			-	300	-	ns
Fall Time	$t_f$	-		150	-	ns	
Turn-On Switching Loss	$E_{on}$	-		4.3	6.3	mJ	
Turn-Off Switching Loss	$E_{off}$	-		1.2	2.1	mJ	
Total Switching Loss	$E_{ts}$	-		5.5	8.4	mJ	
Input Capacitance	$C_{ies}$	$V_{CE}=30V, V_{GE}=0V, f=1MHz$	-	3100	-	pF	
Output Capacitance	$C_{oes}$		-	100	-	pF	
Reverse Transfer Capacitance	$C_{res}$		-	80	-	pF	

# KGT25N120NDA

## ELECTRICAL CHARACTERISTIC OF DIODE

CHARACTERISTIC	SYMBOL	TEST CONDITION		MIN.	TYP.	MAX.	UNIT
Diode Forward Voltage	$V_F$	$I_F = 25A$	$T_C = 25\text{ }^\circ\text{C}$	-	1.8	2.5	V
			$T_C = 125\text{ }^\circ\text{C}$	-	1.9	-	
Diode Reverse Recovery Time	$t_{rr}$	$I_F = 25A$	$T_C = 25\text{ }^\circ\text{C}$	-	230	330	ns
			$T_C = 125\text{ }^\circ\text{C}$	-	300	-	
Diode Peak Reverse Recovery Current	$I_{rr}$	$I_F = 25A$ $di/dt = 200A/\mu s$	$T_C = 25\text{ }^\circ\text{C}$	-	27	35	A
			$T_C = 125\text{ }^\circ\text{C}$	-	31	-	
Diode Reverse Recovery Charge	$Q_{rr}$	$I_F = 25A$ $di/dt = 200A/\mu s$	$T_C = 25\text{ }^\circ\text{C}$	-	3100	4700	nC
			$T_C = 125\text{ }^\circ\text{C}$	-	4650	-	

# KGT25N120NDA

## Typical Performance Characteristics

Fig 1. Saturation Voltage Characteristics

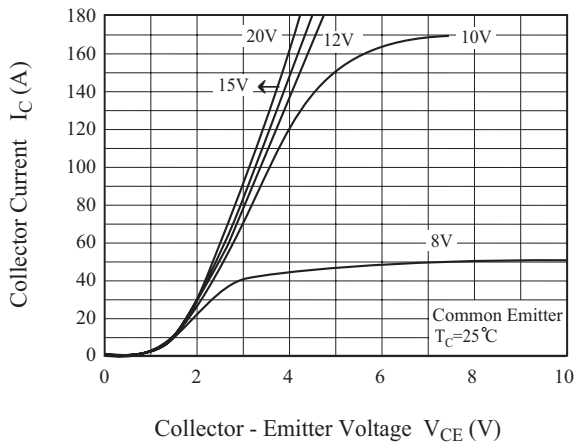

Fig 2. Saturation Voltage Characteristics

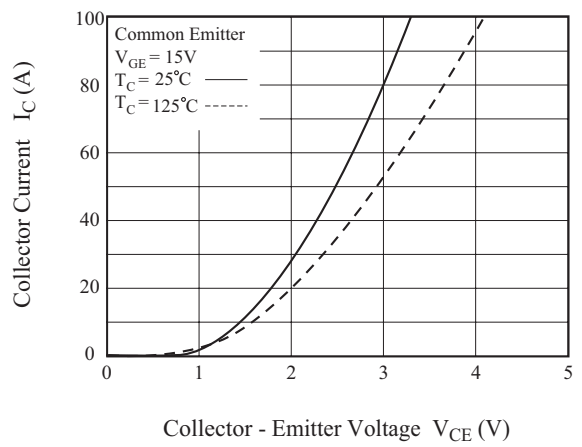

Fig 3. Saturation Voltage vs. Case Temperature

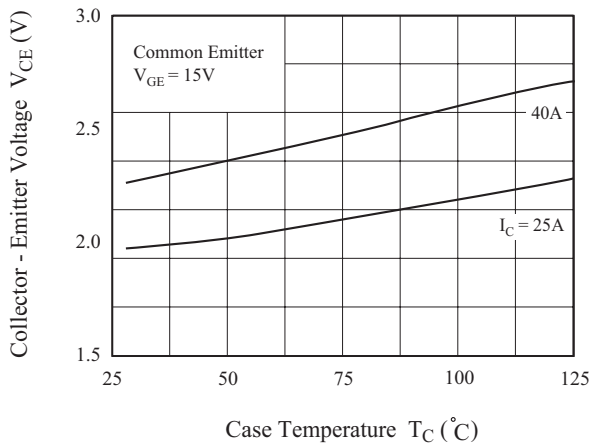

Fig 4. Saturation Voltage vs.  $V_{GE}$

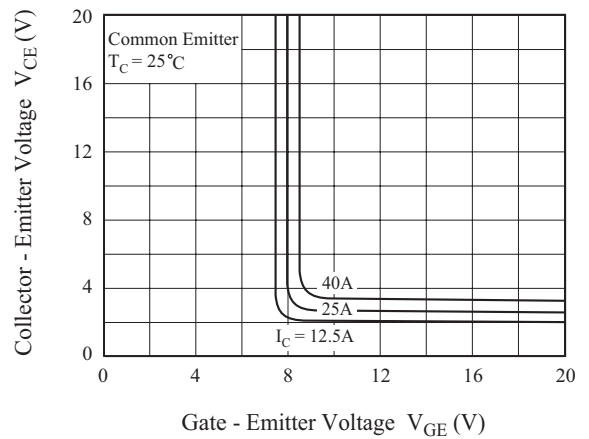

Fig 5. Saturation Voltage vs.  $V_{GE}$

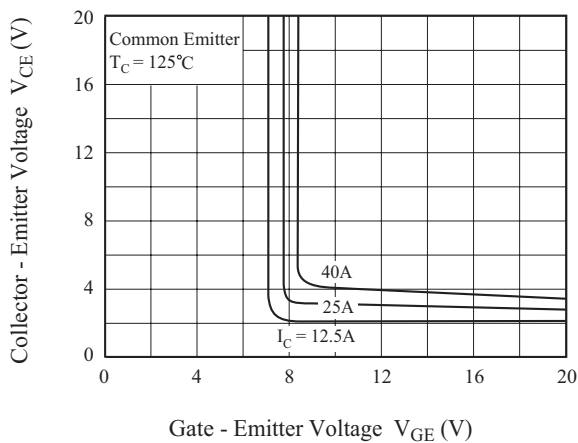
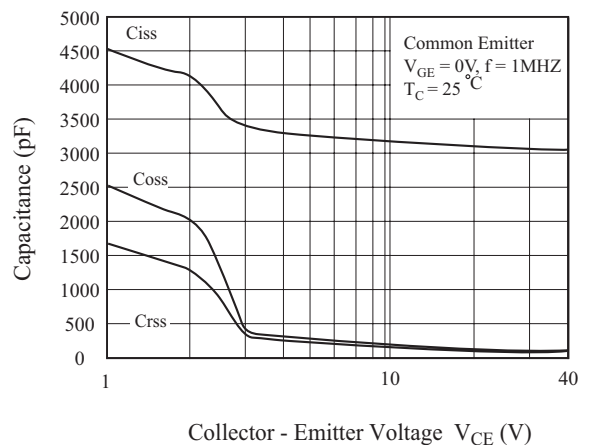

Fig 6. Capacitance Characteristics



# KGT25N120NDA

## Typical Performance Characteristics (Continued)

Fig 7. Turn-On Characteristics vs. Gate Resistance

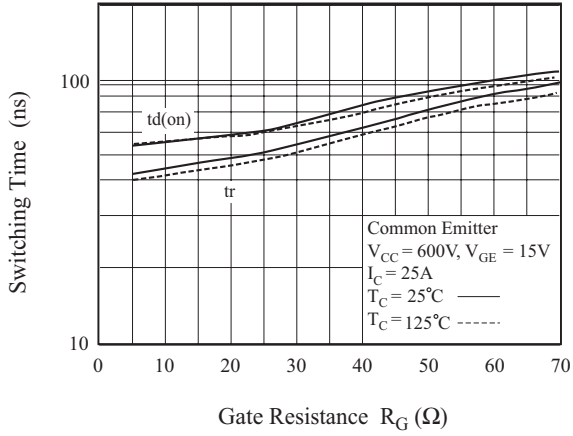

Fig 8. Turn-Off Characteristics vs. Gate Resistance

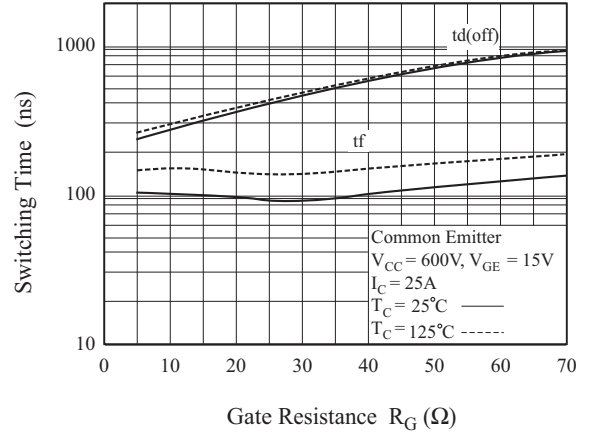

Fig 9. Switching Loss vs. Gate Resistance

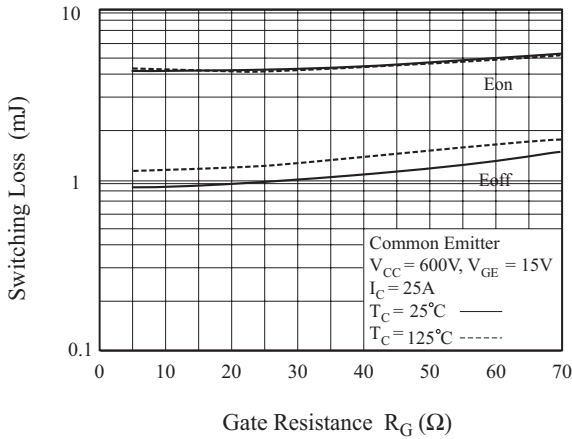

Fig 10. Turn-On Characteristics vs. Collector Current

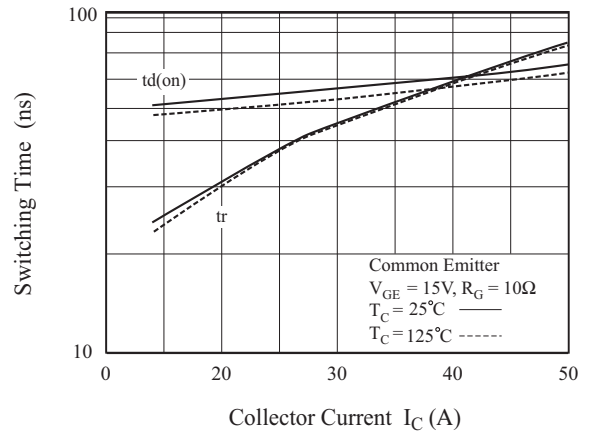

Fig 11. Turn-Off Characteristics vs. Collector Current

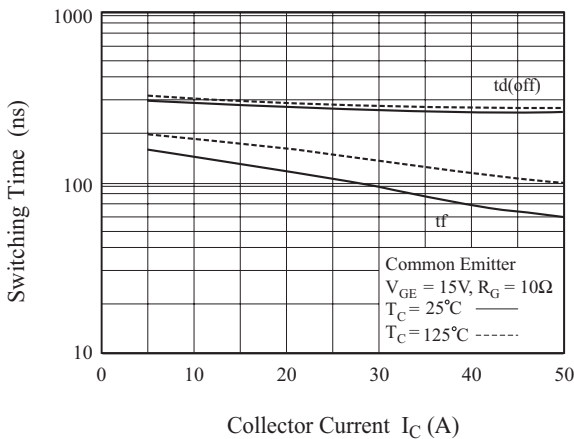
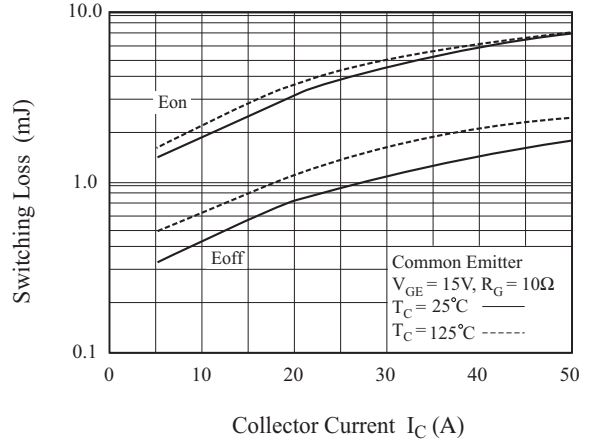

Fig 12. Switching Loss vs. Collector Current



# KGT25N120NDA

## Typical Performance Characteristics (Continued)

Fig 13. Gate Charge Characteristics

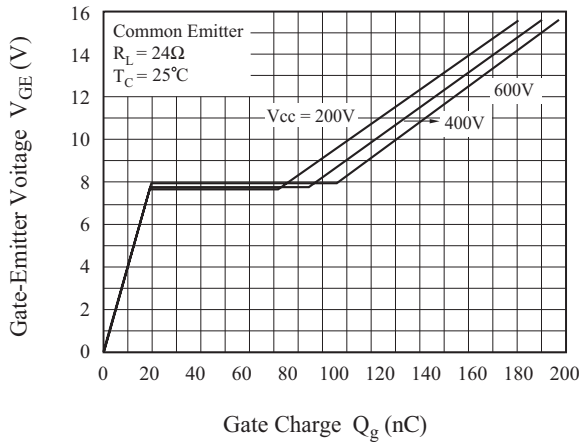

Fig 14. SOA Characteristics

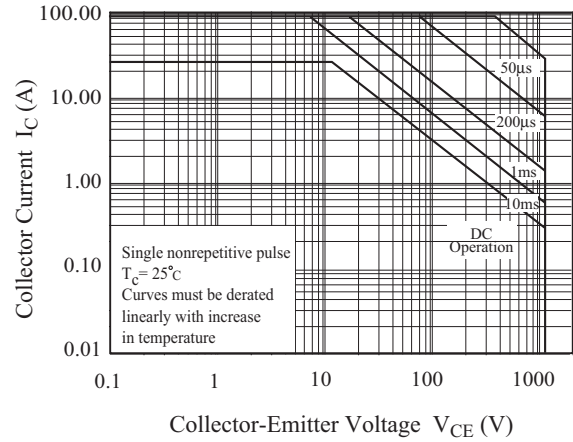

Fig 15. Turn-Off SOA

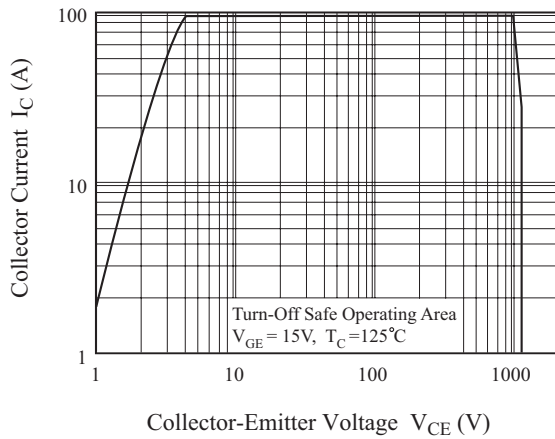
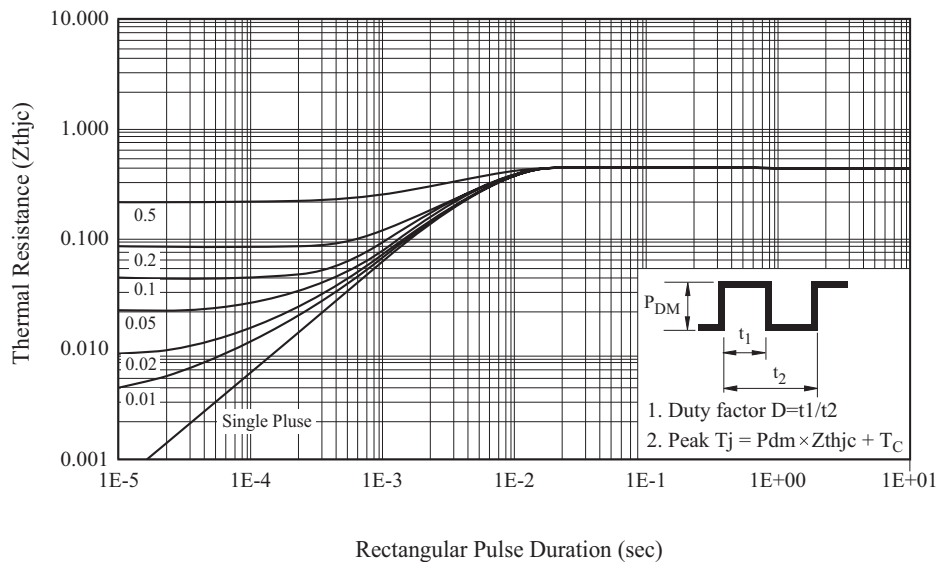

Fig 16. Transient Thermal Impedance of IGBT



# KGT25N120NDA

## Typical Performance Characteristics

Fig 17. Forward Characteristics

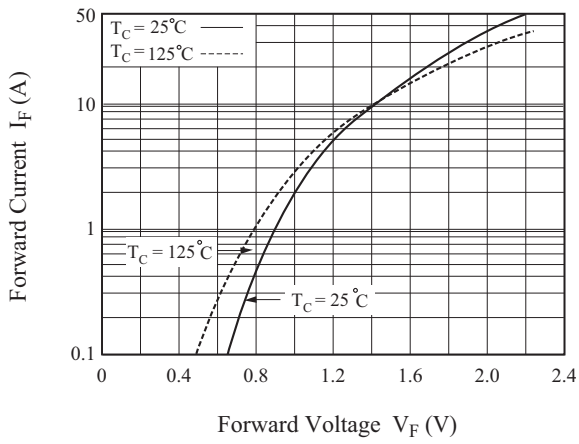

Fig 18. Reverse Recovery Current

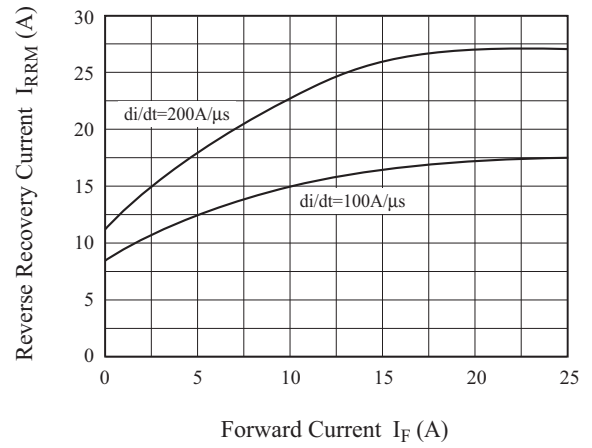
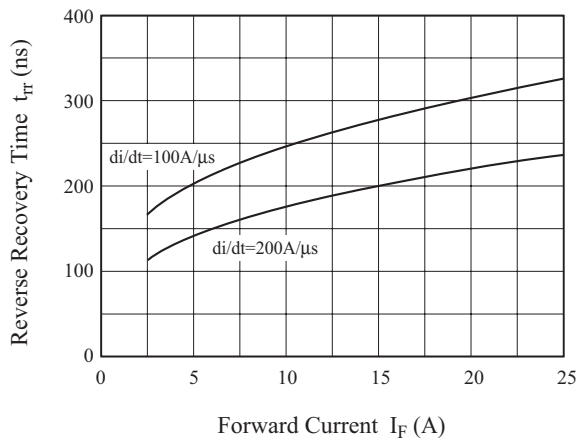

Fig 19. Reverse Recovery Time



# KGT25N120NDA

## Definition Switching Time & Loss.

Fig 21. Switching Test Circuit

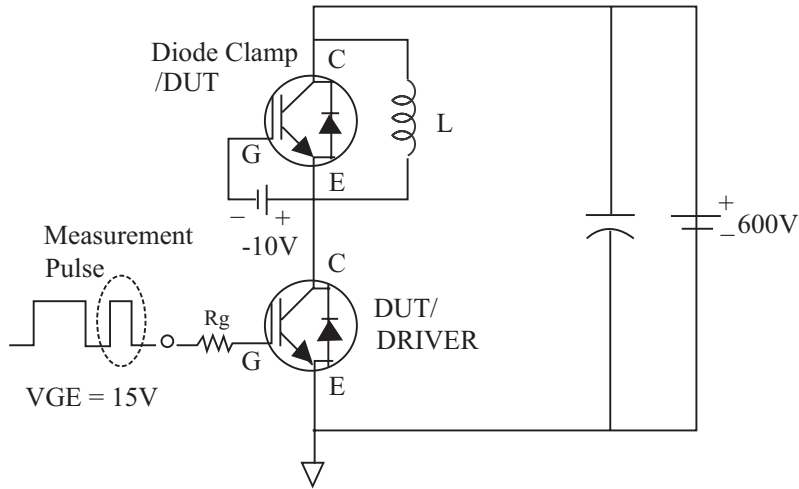

Fig 22. Definition Switching Time & Loss

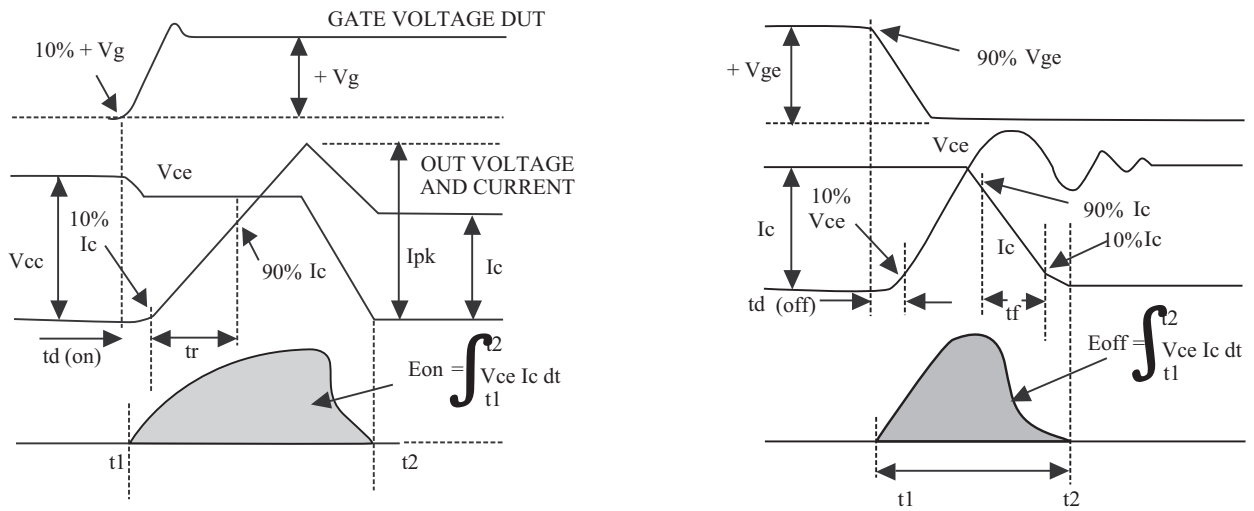

Fig 23. Definition Diode Switching Time

