



C4P-SA04510A001000, C4P- EA04510A001000

deTec4 Prime

SAFETY LIGHT CURTAINS

SICK
Sensor Intelligence.



Ordering information

System part	Type	Part no.
Sender	C4P-SA04510A001000	1215651
Receiver	C4P-EA04510A001000	1215652

Other models and accessories → www.sick.com/deTec4_Prime



Detailed technical data

Features

System part	Sender/receiver pair with system plug and QuickFix bracket	
Usage	As a standalone system and as last system in a cascade	
Resolution	14 mm	
Protective field height	450 mm	
Scanning range	Minimum	0.15 m ... 16 m
	Typical	0.15 m ... 20 m
Response time	12 ms ¹⁾	
No blind zones	✓	
Synchronization	Optical synchronisation	

¹⁾, without beam coding, no cascaded systems. Other response times see operating instructions.

Safety-related parameters

Type	Type 4 (IEC 61496)	
Safety integrity level	SIL3 (IEC 61508) SILCL3 (EN 62061)	
Category	Category 4 (EN ISO 13849)	
Performance level	PL e (EN ISO 13849)	
PFH_D (mean probability of a dangerous failure per hour)	Single device	9.6 x 10 ⁻⁹ (EN ISO 13849)
	Cascade with one guest	1.9 x 10 ⁻⁸ (EN ISO 13849)
	Cascade with two guest devices	2.9 x 10 ⁻⁸ (EN ISO 13849)
T_M (mission time)	20 years (EN ISO 13849)	
Safe state in the event of a fault	At least one OSSD is in the OFF state.	

Functions

	Functions	Delivery status
Restart interlock	✓	Deactivated
External device monitoring (EDM)	✓	Deactivated
Beam coding	✓	Uncoded
Automatic calibration of the protective field width	✓	

Interfaces

System connection		
Connection type	Male connector M12, 5-pin	
Flexi-Loop-ready	✓	
Sender/receiver communication (COM1)	✓ ¹⁾	
Permitted cable length	Receiver power supply: 15 m ²⁾ All additional conductors at the system connection: 37.5 m	
Configuration method		
Cascade	Automatic detection when starting the device	
External device monitoring (EDM)	Automatic detection when starting the device	
Calibration of the protective field width	Automatic detection when starting the device	
Restart interlock	Teach-in procedure when starting the device	
Beam coding	DIP switch	
Reset to factory default	DIP switch	
Status display	LEDs	
Fieldbus, industrial network		
Integration via Flexi Soft safety controller	CANopen, DeviceNet™, EtherCAT®, EtherNet/IP™, Modbus TCP, PROFIBUS DP, PROFINET ³⁾	

¹⁾ Optional: To indicate the status on both sides, the COM1 connections from the sender and receiver must be connected to each other in the control cabinet.

²⁾ If no inductive OSSD loads (e.g., contactors) are in use, the power supply cable for the receiver of a single device (no cascade) can be up to 30 m in length.

³⁾ For additional information on Flexi Soft -> www.sick.com/Flexi_Soft.

Electrical data

Protection class	III (EN 50178) ¹⁾
Supply voltage V_S	24 V DC (19.2 V DC ... 28.8 V DC)
Ripple	≤ 10 % ²⁾
Power consumption typical	3.6 W (DC) / 1.51 W (DC) (depending on type)
Safety outputs (OSSD)	
Type of output	2 PNP semiconductors, short-circuit protected, cross-circuit monitored ³⁾
Switching voltage HIGH	24 V DC ($V_S - 2.25$ V DC ... V_S)
Switching voltage LOW	≤ 2 V DC
Switching current	≤ 500 mA

¹⁾ SELV/PELV safety/protective extra-low voltage.

²⁾ Within the limits of V_S .

³⁾ Applies to the voltage range between -30 V and +30 V.

Mechanical data

Housing cross-section (incl. system connection)	34 mm x 41.1 mm
Housing material	Aluminum extruded profile
Front screen material	Polycarbonate, scratch-resistant coating

Ambient data

Enclosure rating	IP65 (EN 60529) IP67 (EN 60529)
Ambient operating temperature	-30 °C ... +55 °C
Storage temperature	-30 °C ... +70 °C
Air humidity	15 % ... 95 %, Non-condensing
Vibration resistance	5 g, 10 Hz ... 55 Hz (EN 60068-2-6)
Shock resistance	10 g, 16 ms (EN 60068-2-29)

Other information

Wave length	850 nm
Integrated laser alignment aid	✓
Light source	Laser diode
Laser class	1 (IEC 60825-1)
Type of light	Visible red light
Wave length	650 nm

Classifications

ECl@ss 5.0	27272704
ECl@ss 5.1.4	27272704
ECl@ss 6.0	27272704
ECl@ss 6.2	27272704
ECl@ss 7.0	27272704
ECl@ss 8.0	27272704
ECl@ss 8.1	27272704
ECl@ss 9.0	27272704
ETIM 5.0	EC002549
ETIM 6.0	EC002549
UNSPSC 16.0901	46171620

Dimensional drawing (Dimensions in mm (inch))

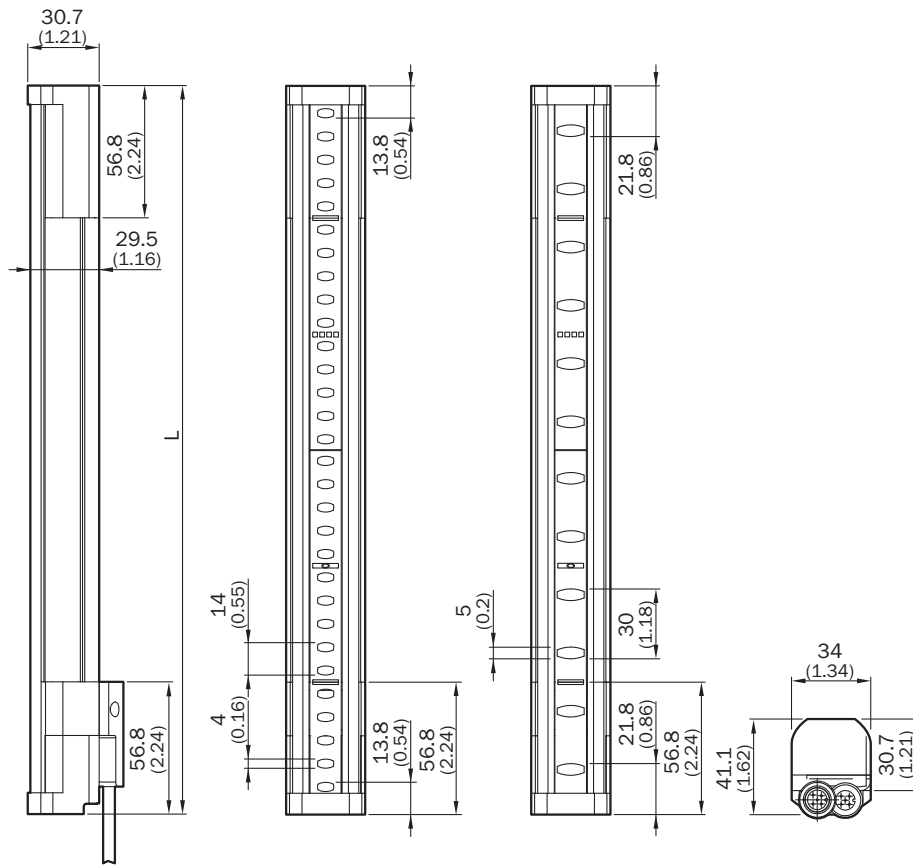

	L
300	313
450	463
600	613
750	763
900	913
1,050	1,063
1,200	1,213
1,350	1,362
1,500	1,512
1,650	1,662
1,800	1,812
1,950	1,962
2,100	2112

Connection diagram

deTec4 Prime safety light curtain to UE10-30S safety relay

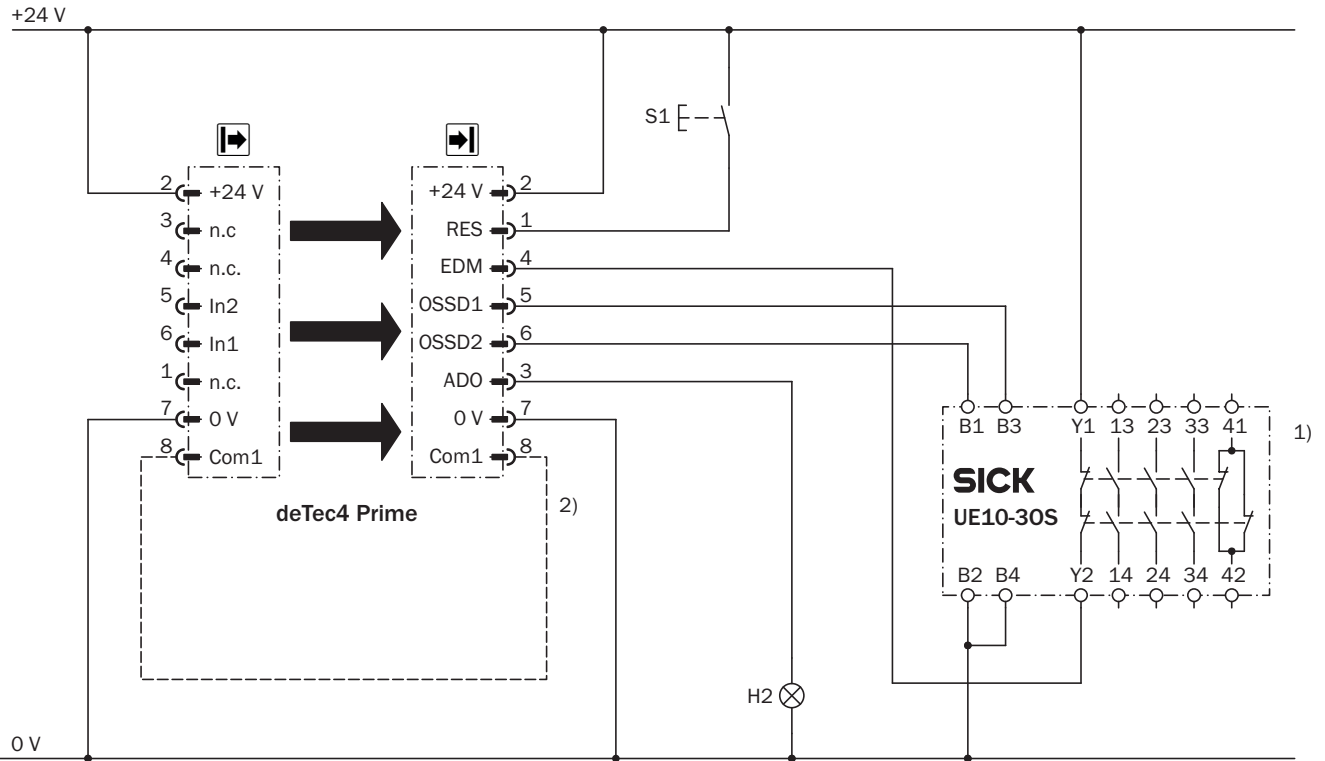

3) PELV

E132908/00/2015-04-07

① Output circuits. These contacts must be incorporated into the control such that the dangerous state is brought to an end if the output circuit is open. For categories 4 and 3, they must be incorporated on two channels (x, y paths). Single-channel incorporation into the control (z path) is only possible with a single-channel control and taking the risk analysis into account.

② To indicate the status on both sides, the Com1 connections from the sender and receiver must be connected to each other in the control cabinet (optional).

③ SELV/PELV safety/protective extra-low voltage.

deTec4 Prime safety light curtain cascade to UE10-30S safety relay

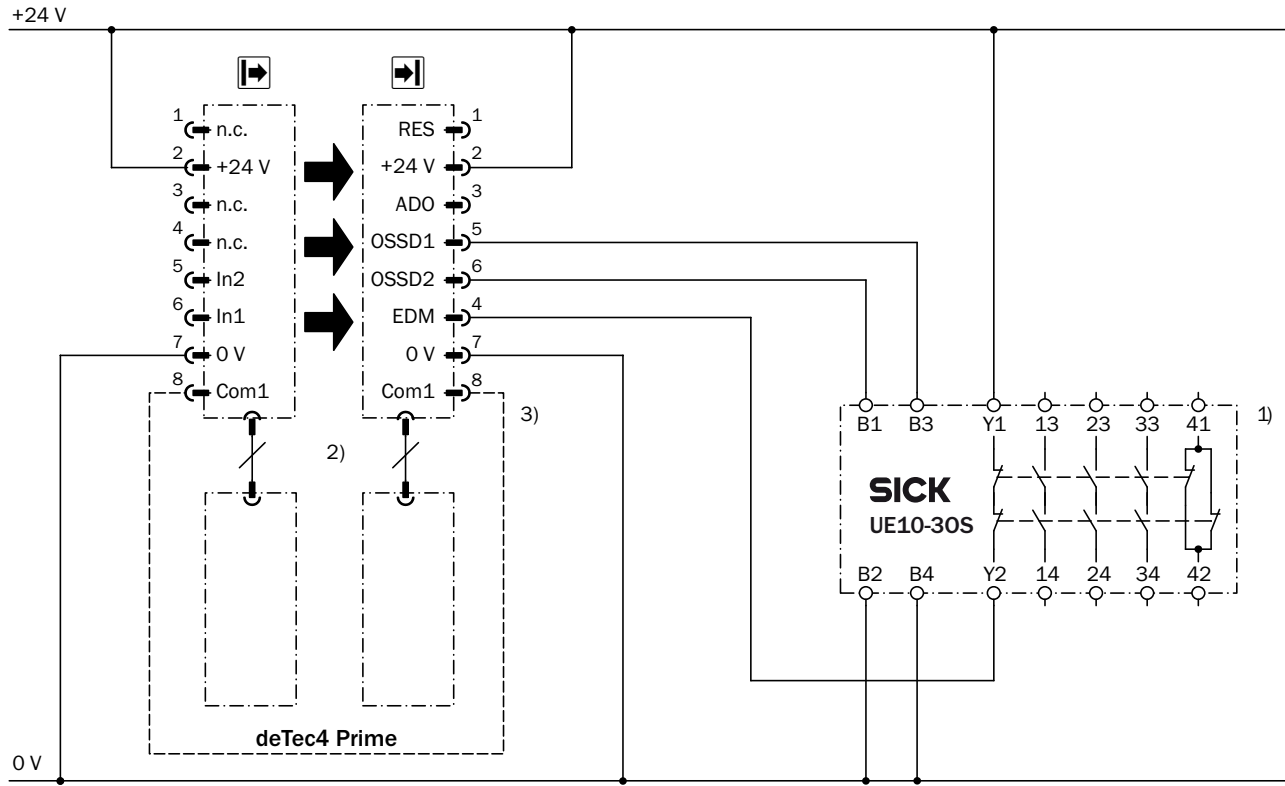

E132954/00/2015-04-07

4) PELV

① Output circuits. These contacts must be incorporated into the control such that the dangerous state is brought to an end if the output circuit is open. For categories 4 and 3, they must be incorporated on two channels (x, y paths). Single-channel incorporation into the control (z path) is only possible with a single-channel control and taking the risk analysis into account.

② Connection of the 5-pin extension connection of the host device to the 5-pin system connection of the guest device.

③ To indicate the status on both sides, the Com1 connections from the sender and receiver must be connected to each other in the control cabinet (optional).

④ SELV/PELV safety/protective extra-low voltage.

deTec4 Prime safety light curtain with T-connector to UE48-20S safety relay

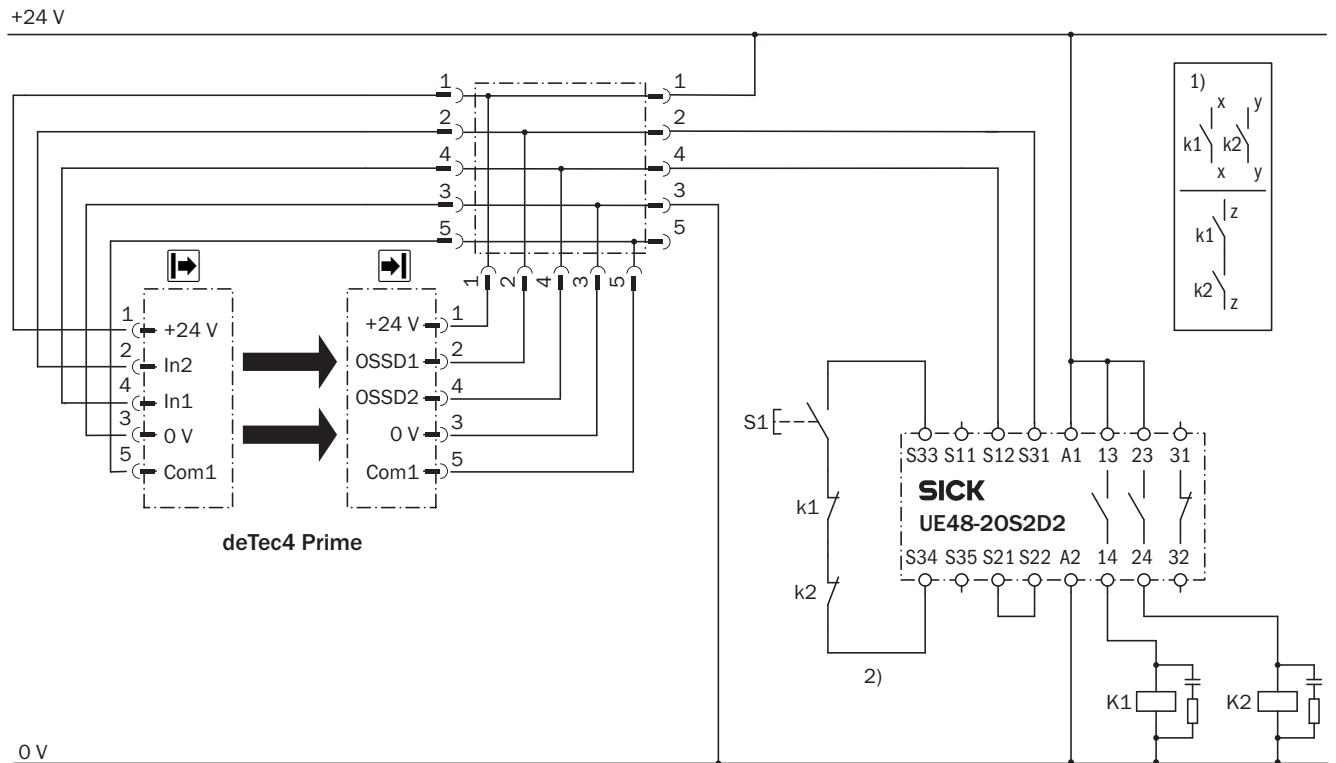

3) PELV

E132906/00/2015-04-07

① Output circuits. These contacts must be incorporated into the control such that the dangerous state is brought to an end if the output circuit is open. For categories 4 and 3, they must be incorporated on two channels (x, y paths). Single-channel incorporation into the control (z path) is only possible with a single-channel control and taking the risk analysis into account.

② External device monitoring is only static.

③ SELV/PELV safety/protective extra-low voltage.

Task

Connection of a deTec4 Prime safety light curtain to a UE48-20S safety relay. Operating mode: with restart interlock and external device monitoring (EDM). The T-piece establishes a connection between the sender and the receiver.

Mode of operation

When the protective field is clear, the OSSD1 and OSSD2 outputs carry voltage. The system can be switched on when K1 and K2 are in a fault-free de-energized position. The UE48-20S is switched on by pressing S1 (pushbutton is pressed and released). The outputs (contacts 13-14 and 23-24) switch the K1 and K2 contactors on. When the protective field is interrupted, the OSSD1 and OSSD2 outputs switch the UE48-20S off. Contactors K1 and K2 are switched off.

Fault analysis

Cross-circuits and short-circuits of the OSSD1 and OSSD2 outputs are recognized and lead to the locking state (lock-out). A malfunction with one of the K1 or K2 contactors is detected. The shut-down function is retained. In the event of manipulation (e.g., jamming) of the S1 pushbutton, the UE48-20S will not re-enable the output current circuits.

Task

Connection of two deTec4 Prime safety light curtains to a UE10-30S safety relay. Operating mode: without restart interlock, with external device monitoring (EDM). If required, the restart interlock is implemented via the machine controller.

Mode of operation

If the protective field is clear and the UE10-30S is in a fault-free de-energized position, the system is enabled. Outputs OSSD1 and OSSD2 carry voltage, the UE10-30S is switched on. When the protective field is interrupted, the OSSD1 and OSSD2 outputs switch the UE10-30S off.

Fault analysis

Cross-circuits and short-circuits of the OSSDs are recognized and lead to the locking state (lock-out). The malfunction of the UE10-30S is detected. The shut-down function is retained.

Task

Connection of a deTec4 Prime safety light curtain to a UE10-30S safety relay. Operating mode: with restart interlock, external device monitoring (EDM), and application diagnostic output.

Mode of operation

If the protective field is clear and the UE10-3OS is in a fault-free de-energized position, the field indicator and the H2 lamp flash. The system can be switched on. The system is enabled by pressing S1 (pushbutton is pressed and released). Outputs OSSD1 and OSSD2 carry voltage, the UE10-3OS is switched on. When the protective field is interrupted, the OSSD1 and OSSD2 outputs switch the UE10-3OS off.

Fault analysis

Cross-circuits and short-circuits of the OSSDs are recognized and lead to the locking state (lock-out). The malfunction of the UE10-3OS is detected. The shut-down function is retained. Manipulation (e.g., jamming) of the S1 pushbutton prevents the output circuits from being enabled.

SICK AT A GLANCE

SICK is one of the leading manufacturers of intelligent sensors and sensor solutions for industrial applications. A unique range of products and services creates the perfect basis for controlling processes securely and efficiently, protecting individuals from accidents and preventing damage to the environment.

We have extensive experience in a wide range of industries and understand their processes and requirements. With intelligent sensors, we can deliver exactly what our customers need. In application centers in Europe, Asia and North America, system solutions are tested and optimized in accordance with customer specifications. All this makes us a reliable supplier and development partner.

Comprehensive services complete our offering: SICK LifeTime Services provide support throughout the machine life cycle and ensure safety and productivity.

For us, that is “Sensor Intelligence.”

WORLDWIDE PRESENCE:

Contacts and other locations –www.sick.com