

FEATURES

- Low turn-on voltage.
- Fast switching.
- Ultra-small surface mount package.
- PN junction guard ring for transient and ESD protection.



Lead-free

APPLICATIONS

- Schottky barrier detector and switching diodes.

ORDERING INFORMATION

Type No.	Marking	Package Code
BAT54WS	L9	SOD-323

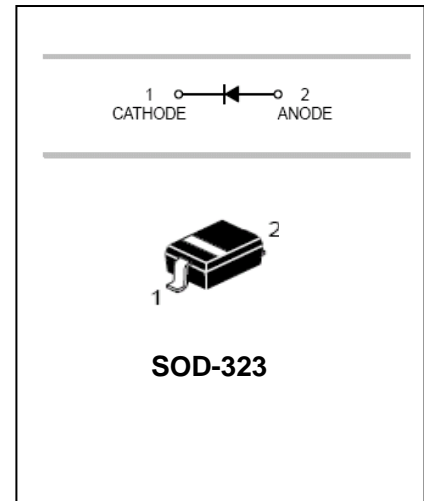

MAXIMUM RATING @ Ta=25°C unless otherwise specified

Parameter	Symbol	Limits	Unit
Peak Repetitive reverse voltage	V_{RRM}	30	V
Working peak reverse voltage	V_{RWM}		
DC reverse voltage	V_R		
RMS Reverse Voltage	$V_{R(RMS)}$	21	V
Average Rectified Output Current	I_O	100	mA
Forward continuous Current	I_F	200	mA
Repetitive peak Forward Current	I_{FRM}	300	mA
Forward Surge Current @t<1.0s	I_{FSM}	600	mA
Power Dissipation	P_d	200	mW
Thermal resistance, junction to ambient air	$R_{\theta JA}$	625	°C/W
Junction temperature	T_j	125	°C
Storage temperature range	T_{stg}	-65-150	°C

ELECTRICAL CHARACTERISTICS @ Ta=25°C unless otherwise specified

Parameter	Symbol	Conditions	Min.	Typ.	Max.	Unit
Reverse Breakdown Voltage	$V_{(BR)R}$	$I_R=100\mu A$	30			V
Forward voltage	V_{F1}	$I_F=0.1mA$			240	mV
	V_{F2}	$I_F=1.0mA$			320	mV
	V_{F3}	$I_F=10mA$			400	mV
	V_{F4}	$I_F=30mA$			500	mV
	V_{F5}	$I_F=100mA$			1000	mV
Reverse leakage current	I_R	$V_R=25V$			2.0	μA
Reverse recovery time	t_{rr}	$I_F=10mA, I_R=10mA$ to $1mA, R_L=100\Omega$			5.0	ns
Junction capacitance	C_J	$V_R=1.0V, f=1.0MHz$			10	pF

TYPICAL CHARACTERISTICS @ $T_a=25^\circ C$ unless otherwise specified

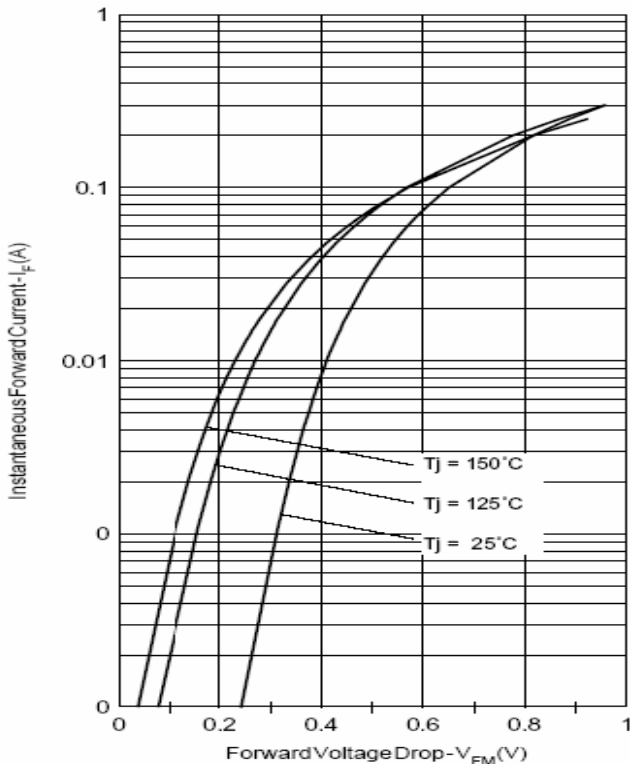

Fig. 1 - Max. Forward Voltage Drop Characteristics (Per Leg)

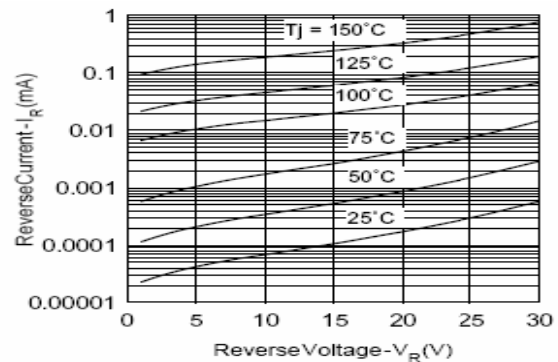

Fig. 2 - Typical Values Of Reverse Current Vs. Reverse Voltage (Per Leg)

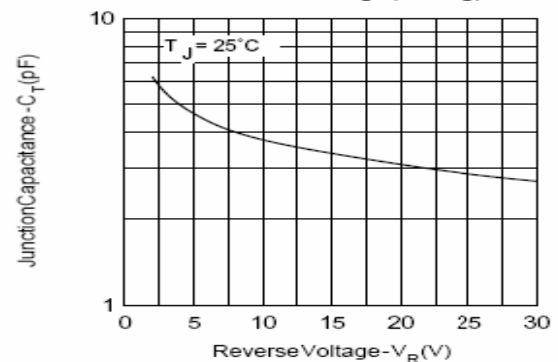

Fig. 3 - Typical Junction Capacitance Vs. Reverse Voltage (Per Leg)

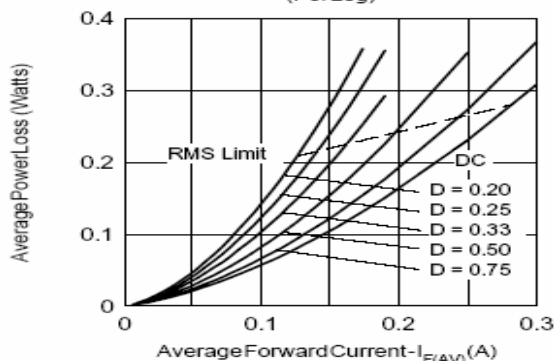

Fig. 4 - Forward Power Loss Characteristics

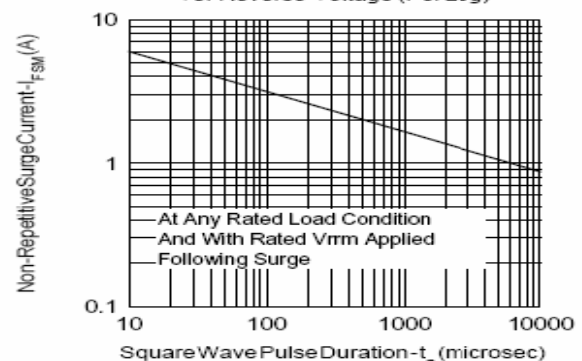
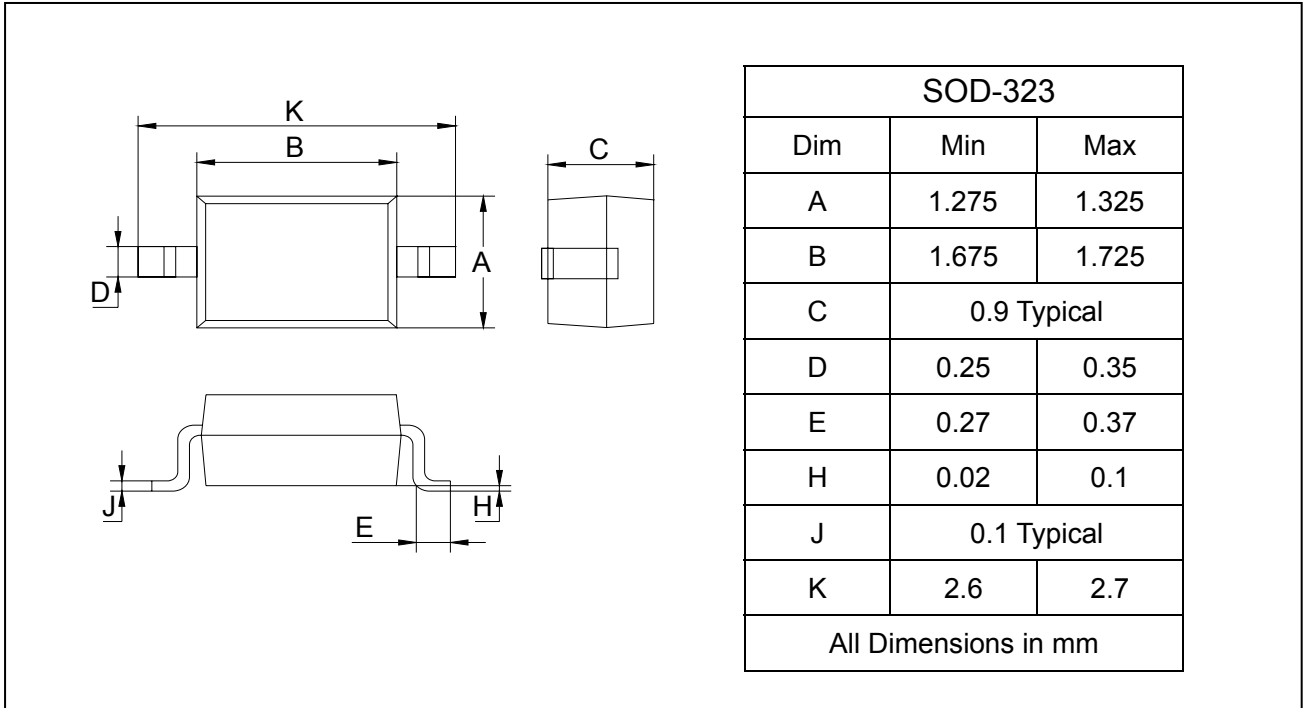

Fig. 5 - Max. Non-Repulsive Surge Current

PACKAGE OUTLINE

Plastic surface mounted package

SOD-323



SOLDERING FOOTPRINT

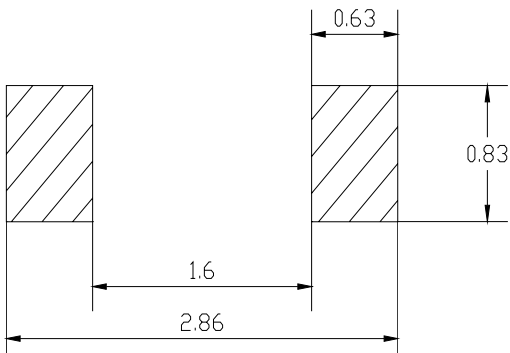

Unit : mm

PACKAGE INFORMATION

Device	Package	Shipping
BAT54WS	SOD-323	3000/Tape&Reel