

Li-Ion linear battery charger with LDO, load switches and reset generator

Datasheet - production data

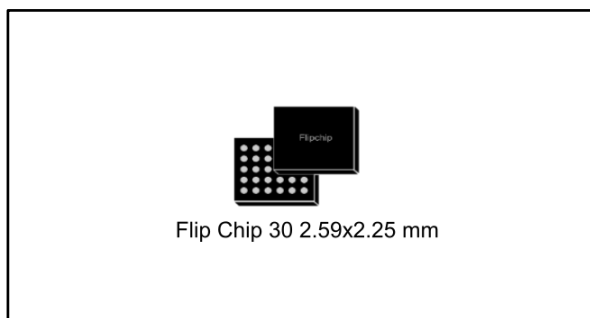

Features

- Charges single-cell Li-Ion batteries with CC/CV algorithm and charge termination
- Fast charge current up to 450 mA
- Pre-charge current from 1 mA to 450 mA
- Adjustable floating voltage up to 4.45 V
- Integrated low quiescent LDO regulator
- Automatic power path management
- Auto-recharge function
- Embedded protection circuit module (PCM) featuring battery overcharge, battery over-discharge and battery overcurrent protections
- Charging timeout to terminate the charging process for safety reasons
- Shipping mode feature allows battery low leakage when over-discharged
- Very low battery leakage in over-discharge and shutdown mode
- Charge/fault status output
- Battery voltage pin to allow external gauging
- Two 3 Ω SPDT load switches
- Reset generator triggered by USB detection
- SWIRE allows the STBC02 functions to be controlled
- Available in Flip Chip 30, 400 um pitch package
- Rugged ±4 kV HBM, ESD protection on the most critical pins

Applications

- Smart watches and wearable devices
- Fitness and medical accessories
- Li-Ion and other Li-Poly battery rechargeable equipment

Description

The STBC02 is a highly integrated power management, embedding a linear battery charger, a 150 mA LDO, 2 SPDT load switches, a smart reset/watchdog block and a protection circuit module (PCM) to prevent the battery from being damaged under fault conditions.

The STBC02 uses a CC/CV algorithm to charge the battery; the fast charge and the pre-charge current can be both independently programmed using dedicated resistors. The termination current is set by default, being 5% of the programmed fast charge current, but it can also be fixed to different values. Likewise, the battery floating voltage value is programmable and can be set to a value up to 4.45 V.

The STBC02 also features a charger enable input to stop the charging process anytime.

The STBC02 is automatically powered off from the connected battery when the IN pin is not connected to a valid power source (battery mode).

A battery under/overtemperature condition can be detected by using an external circuitry (NTC thermistor).

The STBC02 draws less than 10 nA from the connected battery in shipping mode conditions, so to maximize the battery life during end product shelf life. The device is available in the Flip Chip 30 package.

Contents

1 Application schematic 6

2 Pin configuration (top through view) 8

3 Maximum ratings 10

4 Electrical characteristics 11

5 Typical performance characteristics 15

6 Functional pin description 19

 6.1 GND, AGND 19

 6.2 NTC 19

 6.3 ISET and IPRE 19

 6.4 BATMS 19

 6.5 BATSNS, BATSNSFV 20

 6.6 BAT 20

 6.7 IN 20

 6.8 SYS 20

 6.9 LDO 21

 6.10 WAKE-UP 21

 6.11 CHG 21

 6.12 CEN 22

 6.13 RESET_NOW (RESET_CLEAR), nRESET, RST_PENDING 22

 6.13.1 Smart reset section control pins 22

 6.13.2 Watchdog section control pins 23

 6.14 SW1_OA, SW1_OB, SW1_I, SW2_OA, SW2_OB, SW2_I 23

 6.15 SW_SEL 24

7 Block diagram 27

8 Operation description 28

 8.1 Power-on 28

 8.2 Battery charger 28

 8.3 Battery temperature monitoring 32

 8.4 Battery overcharge protection 32

 8.5 Battery over-discharge protection 32

 8.6 Battery discharge overcurrent protection 32

 8.7 Battery fault protection 32



8.8	Floating voltage adjustment	33
8.9	Input overcurrent protection	33
8.10	SYS short-circuit protection, LDO current limitation	33
8.11	IN overvoltage protection	33
8.12	Shutdown mode	33
8.13	Watchdog function	33
8.14	Thermal shutdown.....	33
8.15	Reverse current protection	34
9	Package information	35
9.1	Flip Chip30 (2.59x2.25 mm) package information.....	35
10	Ordering information.....	37
11	Revision history	38

List of tables

Table 1: Typical bill of material (BOM).....	7
Table 2: Pin description	8
Table 3: Absolute maximum ratings	10
Table 4: Thermal data	10
Table 5: Electrical characteristics	11
Table 6: Charging current setting	19
Table 7: SYS voltage source	20
Table 8: CHG pin state	21
Table 9: SWIRE programming.....	24
Table 10: IFAST and IEND	29
Table 11: Flip Chip 30 (2.59x2.25 mm) package mechanical data	36
Table 12: Ordering information	37
Table 13: Document revision history	38

List of figures

Figure 1: STBC02 application schematic.....	6
Figure 2: Pin configuration top through view	8
Figure 3: Battery mode 3 V LDO load transient response	15
Figure 4: Thermal management	15
Figure 5: VIN mode, overvoltage protection	15
Figure 6: Pre-charge to fast charge mode transition threshold	15
Figure 7: Pre-charge to fast charge mode transition deglitch.....	16
Figure 8: Pre-charge to fast charge mode to no charge mode transition	16
Figure 9: Wake-up pin operation	16
Figure 10: VIN plug, charging initialization	16
Figure 11: Wake-up operation, VSYS and LDO rise overview.....	17
Figure 12: Wake-up operation, VSYS and LDO rise detail.....	17
Figure 13: VIN plug, charging initialization battery mode to VIN mode transition	17
Figure 14: Shutdown mode entry and exit.....	17
Figure 15: VBAT to VSYS drop and VSYS to VLDO drop (10 mA).....	18
Figure 16: VBAT to VSYS drop and VSYS to VLDO drop (100 mA).....	18
Figure 17: CEN operation	18
Figure 18: CEN operation, VIN plug/unplug	18
Figure 19: Smart reset timing diagram	22
Figure 20: Watchdog timing diagram.....	23
Figure 21: Single wire programming (SW_SEL INPUT).....	25
Figure 22: Start and stop timing bit range.....	26
Figure 23: STBC02 block diagram.....	27
Figure 24: Charging flowchart.....	30
Figure 25: End-of-charge flowchart	31
Figure 26: CC/CV charging profile (not in scale)	31
Figure 27: Flip Chip 30 (2.59x2.25 mm) package outline.....	35
Figure 28: Flip Chip 30 (2.59x2.25 mm) recommended footprint.....	36

1 Application schematic

Figure 1: STBC02 application schematic

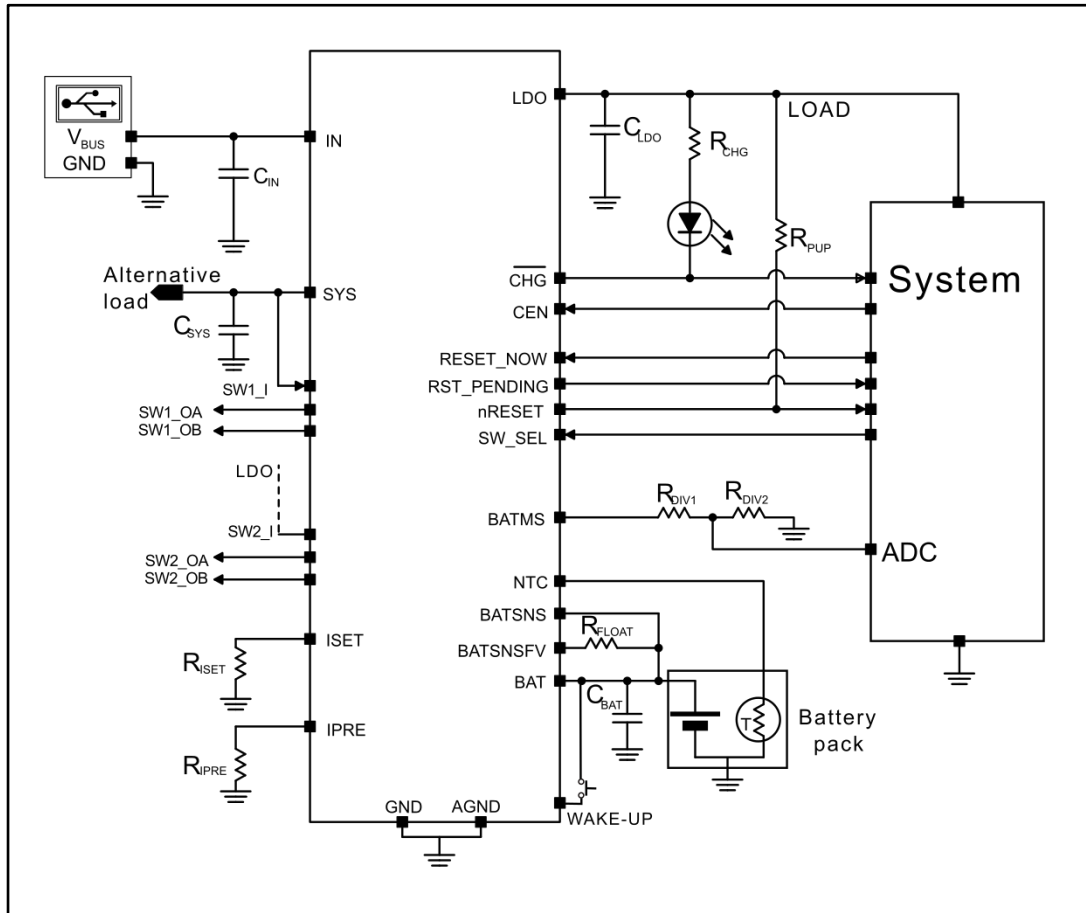

Table 1: Typical bill of material (BOM)

Symbol	Value	Description	Note
C _{IN}	10 μ F (16 V)	Input supply voltage capacitor	Ceramic type
C _{SYS}	1 μ F (10 V)	System output capacitor	Ceramic type
R _{ISET}	Refer to I _{SET}	Charge current programming resistor	Film type
R _{IPRE}	Refer to I _{PRE}	Pre-charge current programming resistor	Film type
C _{BAT}	4.7 μ F (6.3 V)	Battery positive terminal capacitor	Ceramic type
R _{FLOAT}	BATSNSFV	Floating voltage programming resistor	Film type
R _{PUP}	10-100 k Ω	nRESET pull-up resistor ⁽¹⁾	Film type
R _{CHG}	10 k Ω	Charging/fault pull-up resistor ⁽²⁾	Film type
C _{LDO}	1.0 μ F (10 V)	LDO output capacitor	Ceramic type

Notes:

⁽¹⁾R_{PUP} is tied to LDO pin or to a higher voltage.

⁽²⁾R_{CHG} must be calculated according to the external LED electrical characteristics.

2 Pin configuration (top through view)

Figure 2: Pin configuration top through view

A1 RESET_NOW	A2 BATSNSFV	A3 GND	A4 ISET	A5 BAT
B1 CEN	B2 RST_PENDING	B3 BATSNS	B4 AGND	B5 BAT
C1 SW_SEL	C2 NRESET	C3 NC	C4 BATMS	C5 SYS
D1 NTC	D2 WAKE_UP	D3 NC	D4 IPRE	D5 SYS
E1 CHG	E2 SW_I	E3 SW1_OB	E4 SW1_OA	E5 IN
F1 SW2_OB	F2 SW2_OA	F3 SW1_J	F4 LDO	F5 IN

Table 2: Pin description

Bump		Bump name	Description	
Power	IN	E5-F5	Input supply voltage. Bypass this pin to ground with a 10 μ F capacitor	
	BAT	A5-B5	Battery positive terminal. Bypass this pin to GND with a 4.7 μ F ceramic capacitor	
	SYS	C5-D5	System output. Bypass this pin to ground with 1 μ F ceramic capacitor	
	LDO	F4	LDO output. Bypass this pin to ground with 1 μ F ceramic capacitor	
	NTC	D1	Battery temperature monitor pin	
	AGND	B4	Analog ground	Connect together with the same ground layer
	GND	A3	GROUND	
Programming	ISET	A4	Fast charge current programming resistor	
	IPRE	D4	Pre-charge current programming resistor	
Sensing	BATMS	C4	Battery voltage measurement pin	
	BATSNS	B3	Battery voltage sensing. Connect as close as possible to the battery positive terminal	
	BATSNSFV	A2	Floating voltage sensing. Connect as close as possible to the battery positive terminal	
Digital I/Os	CEN	B1	Charger enable pin. Active high. 500 k Ω internal pull-up (to LDO)	
	CHG	E1	Charging/fault flag. Active low (open drain output)	
	WAKE-UP	D2	Shipping mode exit input pin. Active high. 50 k Ω internal pull-down	
	SW_SEL	C1	Load switch selection input (refer to LDO level)	

Bump		Bump name	Description	
Digital I/Os	nRESET	C2	Smart reset output signal (open drain output). A pull-up resistor (10 – 100 kΩ) is connected to LDO pin or to a higher voltage	
	RST_PENDING	B2	Reset output signal (totem pole output)	
	RESET_NOW	A1	Smart reset input signal (referred to LDO level); RESET_CLEAR when watchdog is enabled	
Switch matrix	SW1_I	F3	Load switch SPDT1 input (1.8 V to 5 V range)	If SPDT switches are used, decoupling capacitors are recommended on input and output. Capacitor values depend on application conditions and requirements. If not used, connect inputs and outputs to GND
	SW1_OA	E4	Load switch SPDT1 output A (enabled/disabled by SWIRE)	
	SW1_OB	E3	Load switch SPDT1 output B (enabled/disabled by SWIRE)	
	SW2_I	E2	Load switch SPDT2 input (1.8 V to 5 V range)	
	SW2_OA	F2	Load switch SPDT2 output A (enabled/disabled by SWIRE)	
	SW2_OB	F1	Load switch SPDT2 output B (enabled/disabled by SWIRE)	
	NC	C3-D3	Not connected	Leave floating

3 Maximum ratings

Table 3: Absolute maximum ratings

Symbol	Parameter	Test conditions	Value	Unit
V _{IN}	Input supply voltage pin	DC voltage	-0.3 to +16.0	V
V _{LDO}	LDO output pin voltage	DC voltage	-0.3 to +4.0	V
V _{SYS}	SYS pin voltage	DC voltage	-0.3 to +6.5	V
V _{SW}	Switch pin voltage (SW1_I, SW2_I, SW1_OA, SW1_OB, SW2_OA, SW2_OB)	DC voltage	-0.3 to +6.5	V
V _{CHG}	CHG pin voltage	DC voltage	-0.3 to +6.5	V
V _{Wake-up}	WAKE-UP pin voltage	DC voltage	-0.3 to +4.6	V
V _{LGC}	Voltage on logic pins (CEN, SW_SEL, RESET_NOW, nRESET, RST_PENDING)	DC voltage	-0.3 to +4.0	V
V _{ISET} , V _{IPRE}	Voltage on ISET, IPRE pins	DC voltage	-0.3 to +2	V
V _{NTC}	Voltage on NTC pin	DC voltage	-0.3 to V _{LDO}	V
V _{BAT} , V _{BATSNS} , V _{BATSNSFV}	Voltage on BAT, BATSNS and BATSNSFV pins	DC voltage	-0.3 to +5.5	V
V _{BATMS}	Voltage on BATMS pin	DC voltage	-0.3 to V _{BAT} +0.3	V
ESD	Human body model (IN, SYS, WAKE-UP, LDO, BAT, BATSNS, BATSNSFV)	JS-001-2012 vs. AGND PGND and GND	±4000	V
	Human body model (all the others)	JS-001-2012	±2000	V
T _{AMB}	Operating ambient temperature		-40 to +85	°C
T _J	Maximum junction temperature		+125	°C
T _{STG}	Storage temperature		-65 to +150	°C



Absolute maximum ratings are those values beyond which damage to the device may occur. Functional operation under these conditions is not implied.

Table 4: Thermal data

Symbol	Parameter	Flip Chip 30 (2.25x2.59 mm)	Unit
R _{THJB} ⁽¹⁾	Junction-to-pcb board thermal resistance	50	°C/W

Notes:

⁽¹⁾ Standard FR4 pcb board.

4 Electrical characteristics

$V_{IN}=5\text{ V}$, $V_{BAT}=3.6\text{ V}$, $C_{LDO}=1\text{ }\mu\text{F}$, $C_{BATT}=4.7\text{ }\mu\text{F}$, $C_{IN}=10\text{ }\mu\text{F}$, $C_{SYS}=1\text{ }\mu\text{F}$, $R_{ISET}=1\text{ k}\Omega$, $SD=low$, $CEN=high$, $R_{IPRE}=4.7\text{ k}\Omega$, $T_A=25\text{ }^\circ\text{C}$, $SW_SEL=GND$ or LDO , $RESET_NOW=GND$ or LDO , $WAKE-UP$ floating unless otherwise specified.

Table 5: Electrical characteristics

Symbol	Parameter	Test conditions	Min.	Typ.	Max.	Unit
V_{IN}	Operating input voltage	V_{FLOAT} set 4.2 V, $I_{FAST} < 250\text{ mA}$	4.55		5.4	V
		V_{FLOAT} set 4.45 V, $I_{FAST} < 450\text{ mA}$, $I_{SYS}=I_{LDO}=0\text{ mA}$	4.75		5.4 ⁽¹⁾	V
V_{INOVP}	Input overvoltage protection	V_{IN} rising	5.6	6.0	6.4	V
V_{INOVPH}	Input overvoltage protection hysteresis	V_{IN} falling		200		mV
V_{UVLO}	Undervoltage lock-out	V_{IN} falling		3.9		V
V_{UVLOH}	Undervoltage lock-out hysteresis	V_{IN} rising		300		mV
I_{IN}	IN supply current	Charger disabled mode ($CEN = low$), $I_{SYS}=I_{LDO}=0\text{ A}$		600		μA
		Charging, $V_{HOT} < V_{NTC} < V_{COLD}$, including R_{ISET} current		1.4		mA
V_{FLOAT}	Battery floating voltage	$I_{BAT}=1\text{ mA}$, $BATSNS$ and $BATSNSFV$ short to battery terminal	4.179	4.2	4.221	V
I_{BAT}	BAT pin supply current	Battery-powered mode ($V_{IN} < V_{UVLO}$), $I_{LDO}=0\text{ A}$		4	8	μA
		Charge terminated		9	12	μA
		Shutdown mode (by $SWIRE$)		10	50	nA
		Over-discharge mode ($V_{BAT} < V_{ODC}$, $V_{IN} < V_{UVLO}$)		10	50	
I_{FAST}	Fast charge current	$R_{ISET}=430\text{ }\Omega$, constant-current mode $I_{LDO}+$ $I_{SYS} < 150\text{ mA}$		450	500	mA
		$R_{ISET}=1\text{ k}\Omega$, constant-current mode		200		
I_{PRE}	Pre-charge current	$R_{IPRE}=10\text{ k}\Omega$, constant-current mode		20		mA
V_{ISET}	I_{SET} regulated voltage			1		V
V_{IPRE}	I_{PRE} regulated voltage			1		V
V_{PRE}	Pre-charge to fast charge battery voltage threshold	Charger active		3		V

Symbol	Parameter	Test conditions	Min.	Typ.	Max.	Unit
I _{END}	End-of-charge current	Charging in CV mode for 20 mA < I _{FAST}		5		%I _{FAST}
		Charging in CV mode for I _{FAST} < 20 mA	See Table 10: "IFAST and IEND"			
V _{OCHG}	Battery voltage overcharge threshold	V _{BAT} rising, BATSNSFV short to battery terminal	4.245	4.275	4.305	V
		V _{BAT} rising, BATSNSFV short to battery terminal with floating voltage adjustment enabled		V _{FLOAT} +75		mV
		V _{BAT} rising, external resistor between BATSNSFV and battery terminal		V _{FLOAT} +75		mV
V _{ODC}	Battery voltage over-discharge threshold	V _{IN} < V _{UVLO} , I _{LDO} = 150 mA, BATSNSFV and BATSNS short to battery terminal	2.750	2.8	2.850	V
V _{ODCR}	Battery voltage over-discharge release threshold	V _{UVLO} < V _{IN} < V _{OVP} , I _{LDO} = 150 mA, BATSNSFV and BATSNS short to battery terminal	3.0			V
V _{WAKE-UP}	Wake-up voltage threshold	V _{BAT} > 3 V rising, I _{LDO} = 150 mA	V _{BAT}			V
R _{ON-IS}	Input to SYS on-resistance			0.25	0.35	Ω
R _{ON-BS}	Battery to SYS on-resistance			0.35	0.4	Ω
R _{ON-BATMS}	BATSNS to BATMS on-resistance	I _{SINK} = 500 μA	290		550	Ω
R _{ON-LOADSW1}	Input to output load switch 1 resistance	V _{SW1_I} = 1.8 V to 5 V SW1_OA or SW1_OB test current = 50 mA	2.0		3.8	Ω
R _{ON-LOADSW2}	Input to output load switch 2 resistance	V _{SW2_I} = 1.8 V to 5 V SW2_OA or SW2_OB test current = 50 mA	2.0		3.4	Ω
V _{OL}	Output low level (CHG, nRESET, RST_PENDING)	I _{SINK} = 5 mA			0.4	V
V _{OH}	Output high level (RST_PENDING)	I _{OH} = 5 mA (referred to LDO output)	LDO-200			mV
I _{OHZ}	High level open drain output current (CHG, nRESET)	V _{OH} = 5 V			1	μA
V _{IL}	Logic low input level (CEN, SW_SEL, RESET_NOW)	All versions with LDO 3 V, 3.1 V or 3.3 V			0.4	V
V _{IH}	Logic high input level (CEN, SW_SEL, RESET_NOW)		1.6			V

Symbol	Parameter	Test conditions	Min.	Typ.	Max.	Unit
R _{UP}	CEN pull-up resistor		375	500	625	kΩ
V _{LDO}	LDO output voltage	I _{LDO} =1 mA	-3	V _{LDO} ⁽²⁾	+3	%
ΔV _{OUT-LOAD}	LDO static load regulation	I _{LDO} =1 mA to 150 mA		±0.002	±0.003	%/mA
I _{SC}	LDO short-circuit current	R _{LOAD} =0 Ω	250	350		mA
t _{ON}	LDO turn-on time	0 to 95% V _{LDO} , I _{OUT} =150 mA		210		μs
I _{BATOCP}	Battery discharge overcurrent protection	V _{IN} <V _{UVLO} (powered from BAT), it can be set by 4 SWIRE steps		900		mA
I _{INLIM}	Input current limitation	V _{SYS} > V _{ILIMSCTH} ; V _{UVLO} <V _{IN} < V _{INOVP} (powered from IN)		1.7		A
V _{ILIMSCTH}	SYS voltage threshold for input current limitation short-circuit detection	V _{UVLO} <V _{IN} <V _{INOVP}		2		V
V _{SCSYS}	SYS short-circuit protection threshold	V _{IN} <V _{UVLO} or V _{IN} >V _{INOVP} (powered from BAT)		V _{BAT} -0.8		V
I _{NTCB}	NTC pin bias current	V _{NTC} =0.25 V	45	50	55	μA
V _{HOT}	Thermal hot threshold	Increasing NTC temperature	0.234	0.246	0.258	V
V _{COLD}	Thermal cold threshold	Decreasing NTC temperature	1.28	1.355	1.43	V
T _{HYST}	Hot/cold temperature thresholds hysteresis	10 kΩ NTC, β=3370		3		°C
T _{SD}	Thermal shutdown die temperature			155		°C
T _{WRN}	Thermal warning die temperature			135		°C
t _{PW-VIN}	Minimum input voltage connection time to exit from shutdown mode	V _{BAT} =3.5 V, R _{NTC} =10 kΩ		240		ms
t _{OCD}	Overcharge detection delay	V _{BAT} > V _{OCHG} , V _{UVLO} <V _{IN} <V _{INOVP}		1.2		s
t _{ODD}	over-discharge detection delay	V _{BAT} <V _{ODC} and V _{IN} <V _{UVLO} or V _{IN} > V _{INOVP}		60		ms
t _{DOD}	Discharge overcurrent detection delay	I _{BAT} > I _{BATOCP} , V _{IN} <V _{UVLO} or V _{IN} > V _{INOVP}		10		ms
t _{PFD}	Pre-charge to fast charge transition deglitch time	Rising		100		ms
t _{FPD}	Fast charge to pre-charge fault deglitch time			10		ms

Symbol	Parameter	Test conditions	Min.	Typ.	Max.	Unit
t _{END}	End-of-charge deglitch time			100		ms
t _{PRE}	Pre-charge timeout	V _{BAT} =2 V, charging		1800		s
t _{FAST}	Fast charge timeout		14000	18000	22000	s
t _{CRDD}	Charger restart deglitch time	After end-of-charge, V _{BAT} <3.9 V restart enabled		1200		ms
V _{REC}	Charger restart threshold	After end-of-charge, restart enabled		3.9		V
t _{NTPD}	Battery temperature transition deglitch time			100		ms
t _{PW}	CEN valid input pulse width		15			ms
t _{PW-WA}	WAKE-UP valid input pulse width		1200			ms
t _{Dbus-ires}	Internal RESET deglitch time	From V _{BUS} (V _{IN}) detection to internal RST_PENDING signal		150		ms
t _{DRST_P}	Internal RST_P delay time	From RST_PENDING rising to RST pending GND		4000		ms
t _{nRESETP} ⁽³⁾	nRESET pulse duration	V _{IN} mode		25		μs
		Battery mode		50		

Notes:

(1) If the internal thermal temperature of the STBC02 reaches T_{WRN}, then the programmed I_{FAST} is halved until the internal temperature drops below T_{WRN} - 10 °C typically. A warning is signaled via the CHG output.

(2) Typical voltage depends on the selected order code.

(3) Details can be found inside smart reset section.

5 Typical performance characteristics

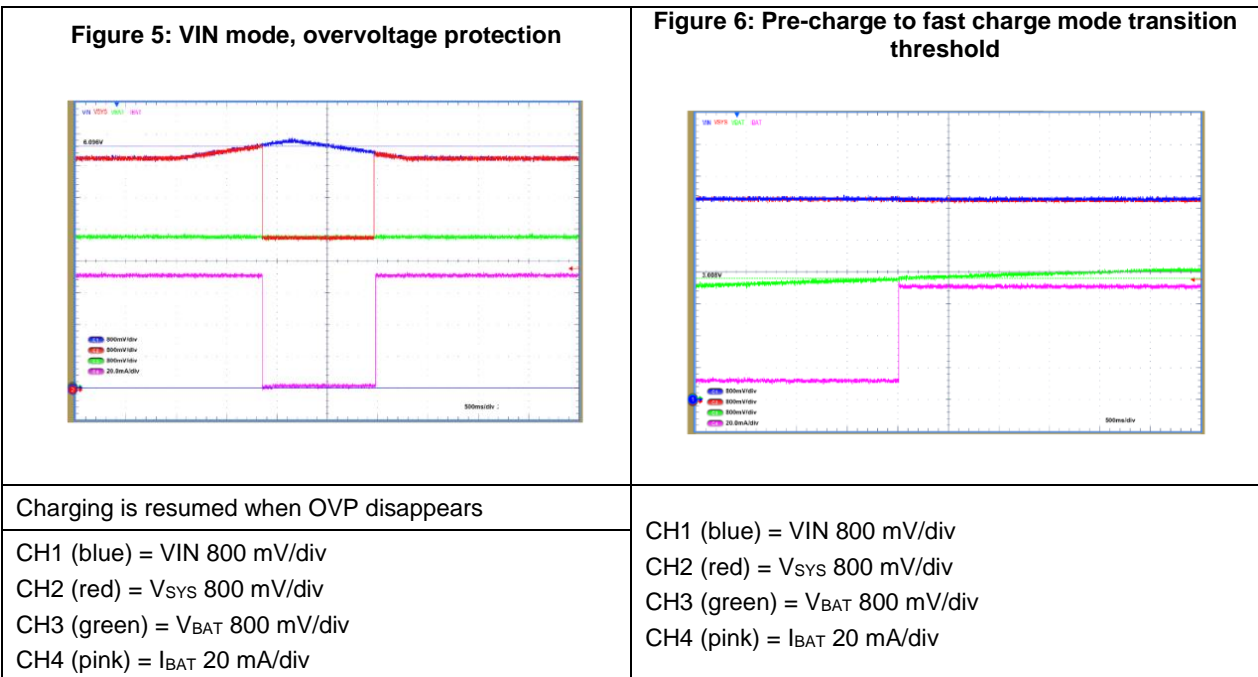
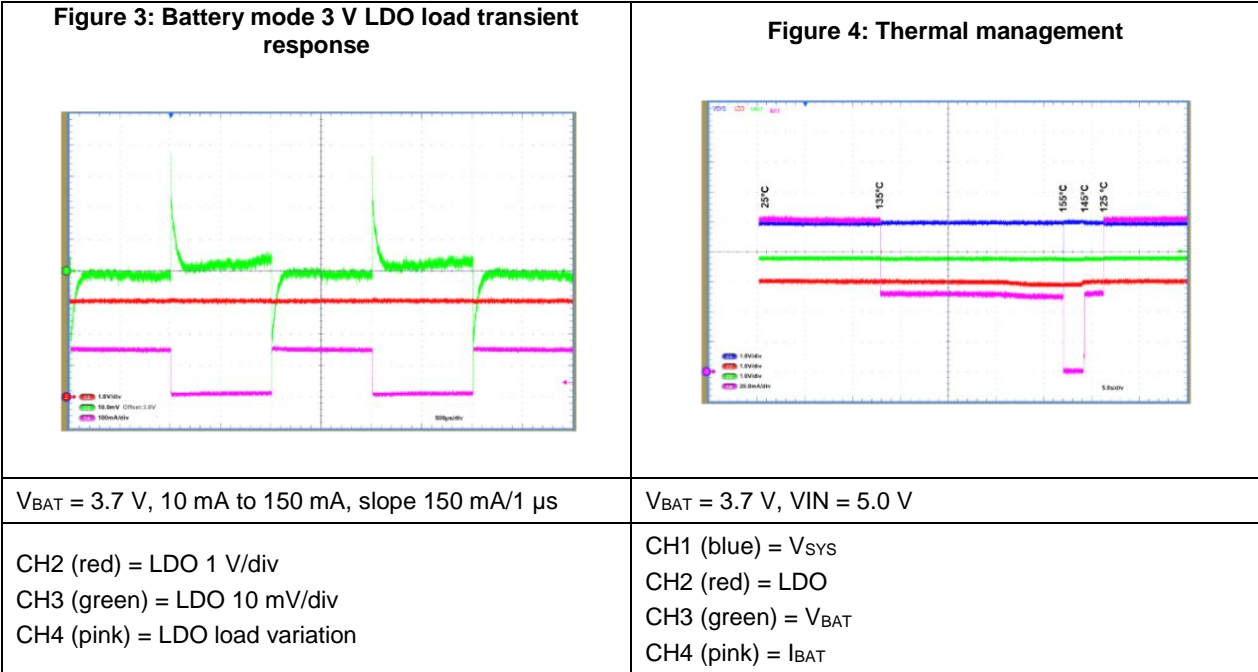

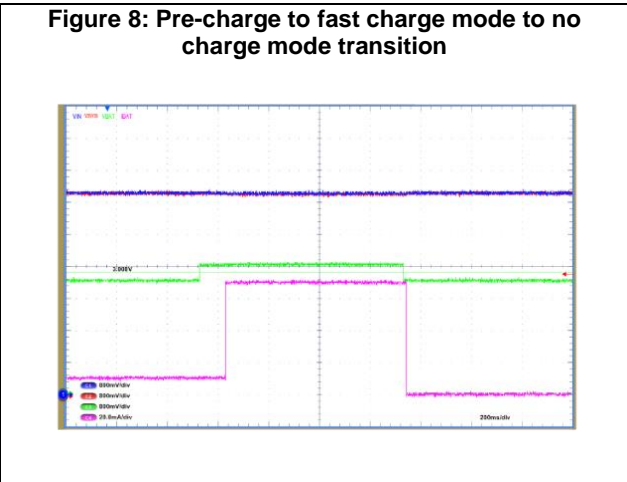
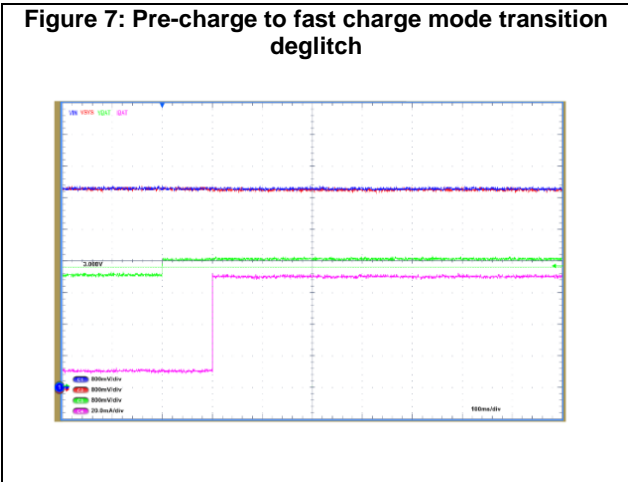

CH1 (blue) = VIN 800 mV/div
 CH2 (red) = V_{sys} 800 mV/div
 CH3 (green) = V_{BAT} 800 mV/div
 CH4 (pink) = I_{BAT} 20 mA/div

CH1 (blue) = VIN 800 mV/div
 CH2 (red) = V_{sys} 800 mV/div
 CH3 (green) = V_{BAT} 800 mV/div
 CH4 (pink) = I_{BAT} 20 mA/div

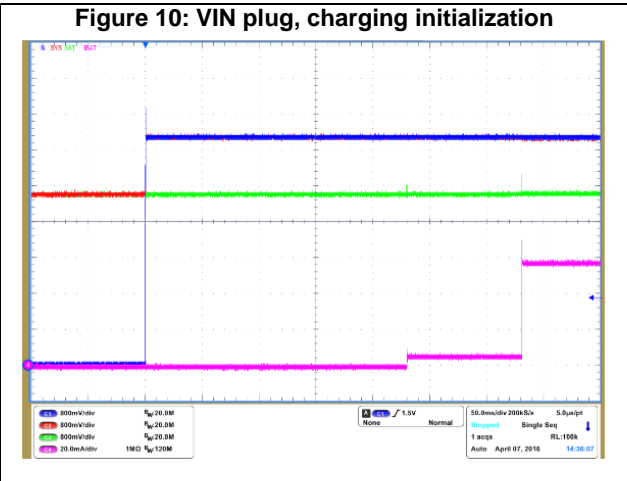
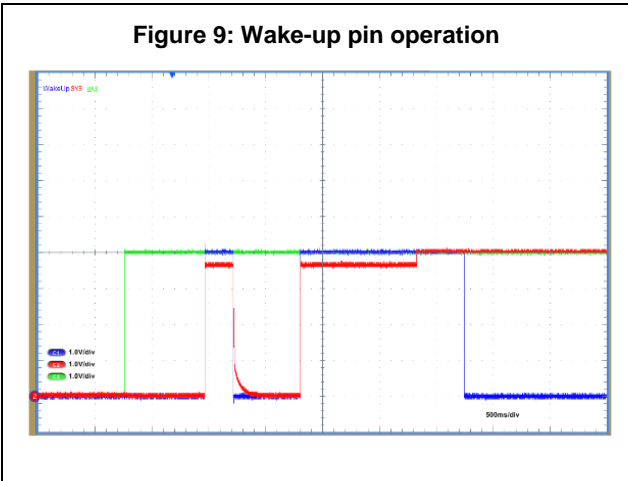

Shutdown mode to battery mode transition. VIN floating
 CH1 (blue) = WAKE-UP pin 800 mV/div
 CH2 (red) = V_{sys} 800 mV/div
 CH3 (green) = V_{BAT} 800 mV/div

Shutdown mode to VIN mode transition
 CH1 (blue) = VIN 800 mV/div;
 CH2 (red) = V_{sys} 800 mV/div
 CH3 (green) = V_{BAT} 800 mV/div
 CH4 (pink) = I_{BAT} 20 mA/div

Figure 11: Wake-up operation, VSYS and LDO rise overview

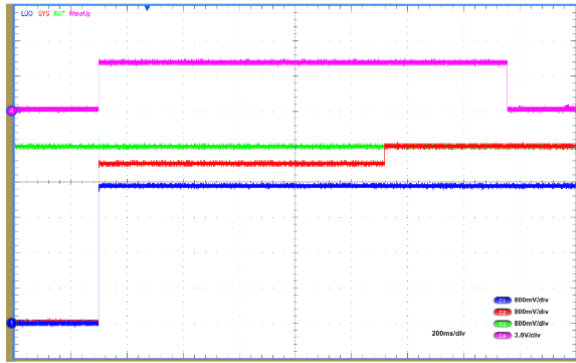

CH1 (blue) = V_{LDO} 800 mV/div
 CH2 (red) = V_{SYS} 800 mV/div
 CH3 (green) = V_{BAT} 800 mV/div
 CH4 (pink) = Wake-up 3 V/div

Figure 12: Wake-up operation, VSYS and LDO rise detail

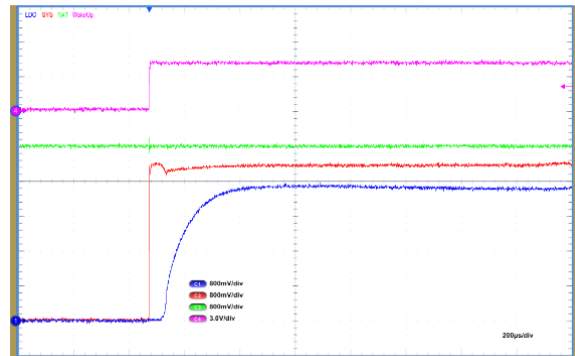

CH1 (blue) = V_{LDO} 800 mV/div
 CH2 (red) = V_{SYS} 800 mV/div
 CH3 (green) = V_{BAT} 800 mV/div
 CH4 (pink) = Wake-up 3 V/div

Figure 13: VIN plug, charging initialization battery mode to VIN mode transition

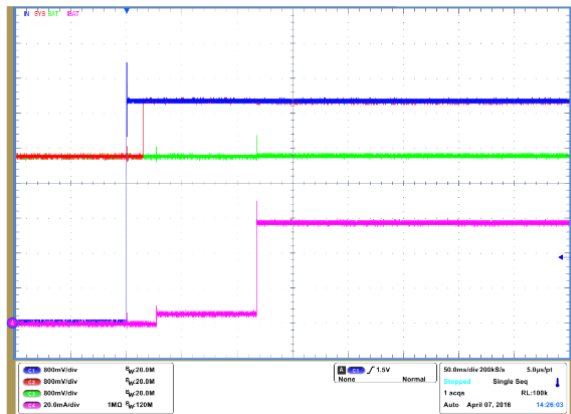

CH1 (blue) = V_{IN} 800 mV/div
 CH2 (red) = V_{SYS} 800 mV/div
 CH3 (green) = V_{BAT} 800 mV/div
 CH4 (pink) = I_{BAT} 20 mA/div

Figure 14: Shutdown mode entry and exit

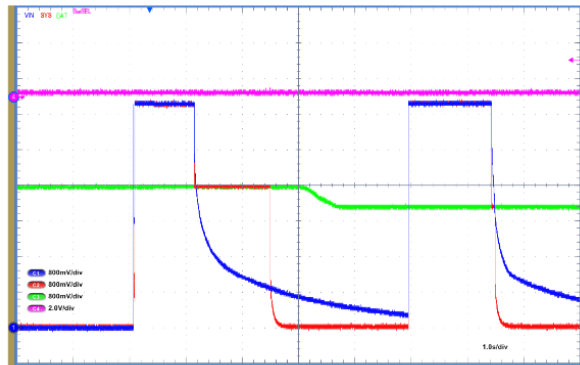

By SW_SEL command, battery level over V_{ODC} and below V_{ODC}

CH1 (blue) = V_{IN} 800 mV/div
 CH2 (red) = V_{SYS} 800 mV/div
 CH3 (green) = V_{BAT} 800 mV/div
 CH4 (pink) = SW_SEL 2 V/div

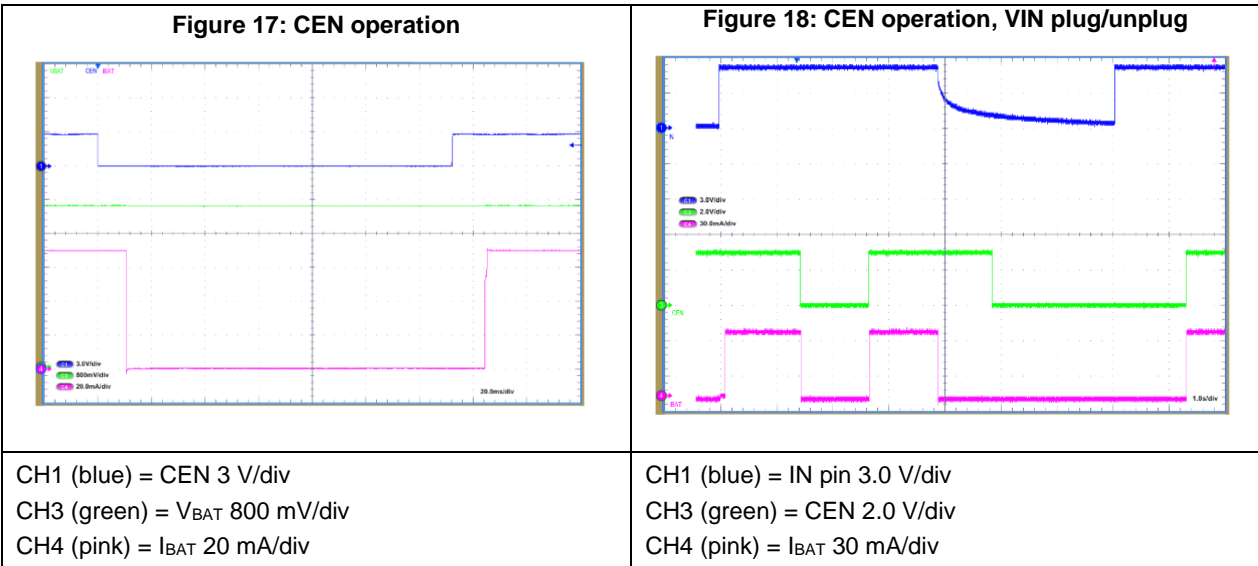
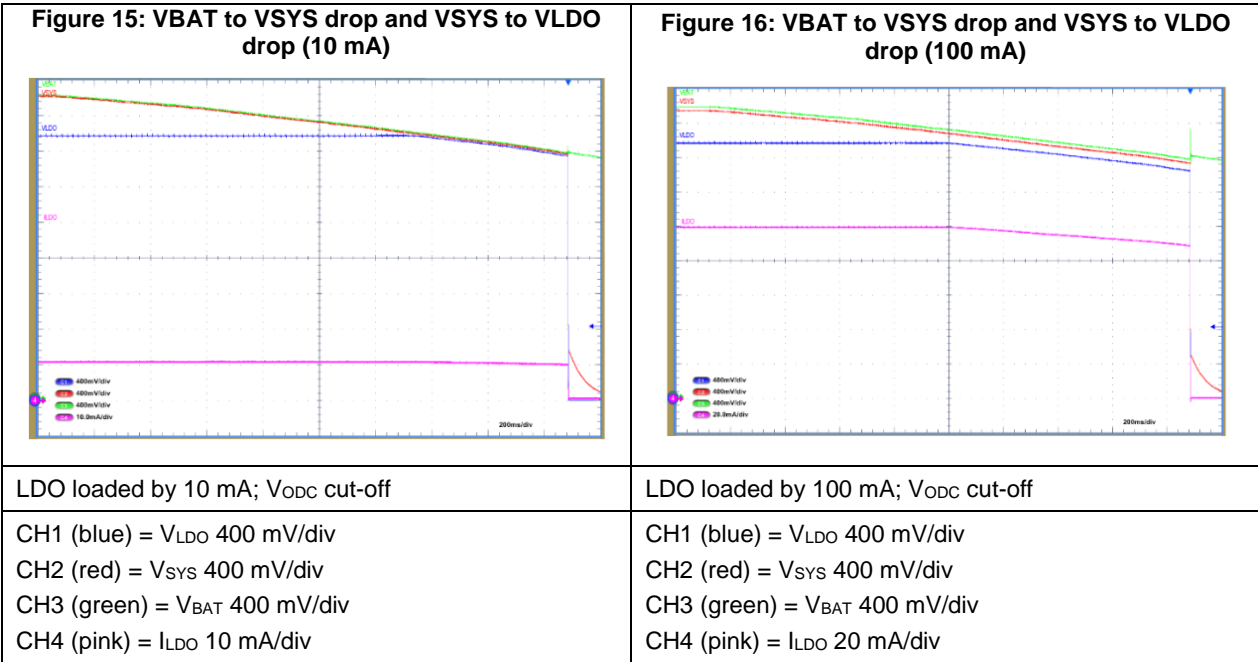

6 Functional pin description

6.1 GND, AGND

The STBC02 ground pins.

6.2 NTC

The battery temperature monitoring pin. Connect the battery NTC thermistor to this pin. The charging cycle stops when the battery temperature is outside of the safe temperature range (0 °C to 45 °C). When the charging cycle is completed, the NTC pin goes to a high impedance state, therefore the NTC thermistor can be also used, together with an external circuitry, to monitor the battery temperature while it is discharging. If the NTC thermistor is not used, a 10 kΩ resistor must be connected to ensure proper IC operations.

6.3 ISET and IPRE

Fast and pre-charge current programming pins. Connect two resistors (R_{ISET} , R_{IPRE}) to ground to set the fast and pre-charge current (I_{FAST} , I_{PRE}) according to the following equation (valid for I_{FAST} , $I_{PRE} > 5$ mA):

Equation 1:

$$I_{PRE} = \frac{V_{IPRE}}{R_{IPRE}} * K; I_{FAST} = \frac{V_{ISET}}{R_{ISET}} * K$$

Where $V_{ISET} = V_{IPRE} = 1$ V and $K = 200$. Fast charge and pre-charge currents can be independently set from 1 mA to 450 mA. End-of-charge current value is typically 5% of the fast charging current value being set.

For low charging current (I_{FAST} , $I_{PRE} < 5$ mA), the R_{ISET} and R_{IPRE} values in following table must be used.

Table 6: Charging current setting

I_{FAST} , I_{PRE}	R_{ISET} , R_{IPRE}
5 mA	40.5 k
2 mA	110 k
1 mA	260 k

Both R_{ISET} and R_{IPRE} must be always used. Short-circuit to ground or open circuit are not allowed options.

6.4 BATMS

Battery voltage measurement. BATMS pin is internally shorted to the BATSNS pin during normal conditions to monitor the battery voltage using external components (μ C and embedded ADC). The internal path from BATMS pin to the battery is opened in case any of the following conditions occur: overcurrent, battery over-discharge, shutdown mode, short-circuit on SYS or LDO. This function can be enabled / disabled by SWIRE. To minimize overall system power consumption, this function must be disabled.

6.5 BATSNS, BATSNSFV

Battery voltage sense pin. The BATSNS pin must be connected as close as possible to the battery positive terminal to ensure the maximum accuracy on the floating voltage and on the battery voltage protection thresholds. The BATSNSFV pin can be used to fix the V_{FLOAT} value by connecting a proper external series resistor (to BATSNSFV). The battery floating voltage can be set up to 4.45 V according to the following equation:

Equation 2:

$$Vfloat_{adj} = Vfloat_{def} * \left(1 + \frac{R_{float}}{1M\Omega}\right) V = 4.2 * \left(1 + \frac{R_{float}}{1M\Omega}\right) V$$

Example: to set the battery floating voltage at 4.35 V, refer to the following equation.

Equation 3:

$$R_{ext} = 1M\Omega * \left(\frac{Vfloat_{adj}}{4.2V} - 1\right) = 1M\Omega * \left(\frac{4.35V}{4.2V} - 1\right) = 35.7K\Omega$$

If the BATSNSFV pin is connected to the battery positive terminal, the floating voltage is set at its 4.2 V default value.

6.6 BAT

External battery connection pin (positive terminal). A 4.7 μ F ceramic bypass capacitor must be connected to GND.

6.7 IN

5 V input supply voltage pin. The STBC02 is powered off from this pin when a valid voltage source is detected, meaning a voltage higher than V_{UVLO} and lower than V_{INOVP} . A 10 μ F ceramic bypass capacitor must be connected to GND.

6.8 SYS

The internal LDO input voltage and external unregulated supply pin. The maximum current deliverable through this pin depends on the following two conditions: LDO load and battery status. However, if none of the above loads sink current, the maximum SYS current budget is 450 mA, provided that the input voltage source can deliver that amount of current.

SYS voltage source can be either IN or BAT, depending on the operating conditions (refer to the following table). A ceramic bypass capacitor of 1 μ F must be connected to GND.

Table 7: SYS voltage source

V_{IN}	V_{BAT}	SYS status	LDO status
$< V_{UVLO}$	$< V_{ODC}^{(1)}$	Not powered	Off
$< V_{UVLO}$	$> V_{ODC}$	$V_{BAT}^{(2)}$	On
$> < V_{UVLO}$ and $< V_{INOVP}$	X (don't care) ⁽³⁾	V_{IN}	On
$> V_{INOVP}$	$< V_{ODC}$	Not powered	Off
$> V_{INOVP}$	$> V_{ODC}$	$V_{BAT}^{(2)}$	On

Notes:

⁽¹⁾ V_{ODCR} if the shutdown mode or the over-discharge protection has been previously activated.

⁽²⁾Voltage drop over internal MOSFET is not included.

⁽³⁾Battery disconnected (0 V) or fully discharged. Resistive short-circuit is not supported for safety reasons.

6.9 LDO

LDO output voltage pin. The regulated voltage (it can be 3 V, 3.1 V, or 3.3 V) depends on the selected STBC02 order code. The maximum current capability is anyhow 150 mA. A 1 μ F ceramic bypass capacitor must be connected to GND.

6.10 WAKE-UP

Wake-up input pin. To restore normal operations of the STBC02, so to exit from a shutdown condition, connect the WAKE-UP pin to the battery voltage. The STBC02 is enabled to operate in normal conditions again, only if the battery voltage is higher than V_{ODCR} (3 V). A deglitch delay is implemented to prevent unwanted false operations. The above-described WAKE-UP pin functionality is disabled when a valid V_{IN} voltage source is detected. The pin has an internal 50 k Ω pull-down resistor.

6.11 CHG

Active low, open drain charging/fault flag output pin. The CHG provides status information about V_{IN} voltage level, battery charging status and faults by toggling at different frequencies as reported in the table below.

Table 8: CHG pin state

Device state	CHG pin state	Note
Not valid input ($V_{IN} < V_{BAT}$ or $V_{IN} > V_{INOVP}$ or $V_{IN} < V_{INUVLO}$)	High Z (high by external pull-up)	
Valid input ($V_{IN} > V_{INUVLO}$, $V_{IN} < V_{INOVP}$, $V_{BAT} < V_{IN}$ and CEN low)	Low	
End-of-charge (EOC)	Toggling 4.1 Hz (until USB is disconnected)	In case of synchronous alarm events, the highest toggling frequency has higher priority. Example: NTC warning and EOC are concurrent events. NTC warning, signaled by toggling CHG at 16.2 Hz is the only signal available till the battery temperature goes back to a safe range (0 °C to 45 °C). If an EOC condition is still present then a 4.1 Hz toggling signal is present.
Charging phase (pre and fast)	Toggling 6.2 Hz	
Overcharge fault	Toggling 8.2 Hz	
Charging timeout (pre-charge, fast charge)	Toggling 10.2 Hz	
Battery voltage below V_{PRE} after the fast charge starts	Toggling 12.8 Hz	
Charging thermal limitation (thermal warning)	Toggling 14.2 Hz	
Battery temperature fault (NTC warning)	Toggling 16.2 Hz	

6.12 CEN

Internal CC/CV charger block enable pin. A low logic level on this pin disables the internal CC/CV charger block. Transitioning CEN from high to low and then back to high, allows the CC/CV charger block to be restarted if it was stopped due to one of the following conditions:

- Charging timeout (pre-charge, fast charge)
- Battery voltage below V_{PRE} after the fast charge has already started
- End-of-charge

CEN has no effect if the charging cycle has been stopped by a battery overcharge condition.

If the CC/CV charger stops the charging cycle due to an out of range battery temperature, a low logic level on the CEN pin disables the CC/CV charger and resets the charging timeout timers. If CEN is set high, the CC/CV charger restarts normal operations, assuming that no fault condition is detected. CEN is internally pulled up to LDO via a 500 kΩ resistor and must be either left floating or tied to LDO when the STBC02 is powered for the first time. Should the auto-recharge function be enabled, the CC/CV charger restarts automatically charging the battery if V_{BAT} goes below 3.9 V; a deglitch time delay has been added to prevent unwanted charging cycle restarts.

6.13 RESET_NOW (RESET_CLEAR), nRESET, RST_PENDING

The device features reset/watchdog circuits meant to be used in conjunction with the external application processor or with other embedded devices; it provides a reset signal or a watchdog expiration information. The reset signal and the watchdog timer expiration have no impact on the STBC02 operations.

6.13.1 Smart reset section control pins

The smart reset circuit is active only when a valid V_{IN} is present ($V_{UVLO} < V_{IN} < V_{INOVP}$). The STBC02 features a 150 ms deglitch time, starting from the valid V_{IN} detection, and it is meant to avoid false triggering due to signal bounces. After V_{IN} is considered to be valid and the deglitch time has expired, the RST_PENDING signal goes to a high logic level. An nRESET signal is generated automatically after a 4000 ms delay, starting from the end of the deglitch time, or anytime earlier if a RESET_NOW signal is applied. This is a sole event and no other nRESET signal is generated as long as V_{IN} is disconnected and reconnected again. The RST_PENDING signal remains at a high logic level until when one of the two prior conditions is met. For more details refer to the following timing diagram.

Figure 19: Smart reset timing diagram

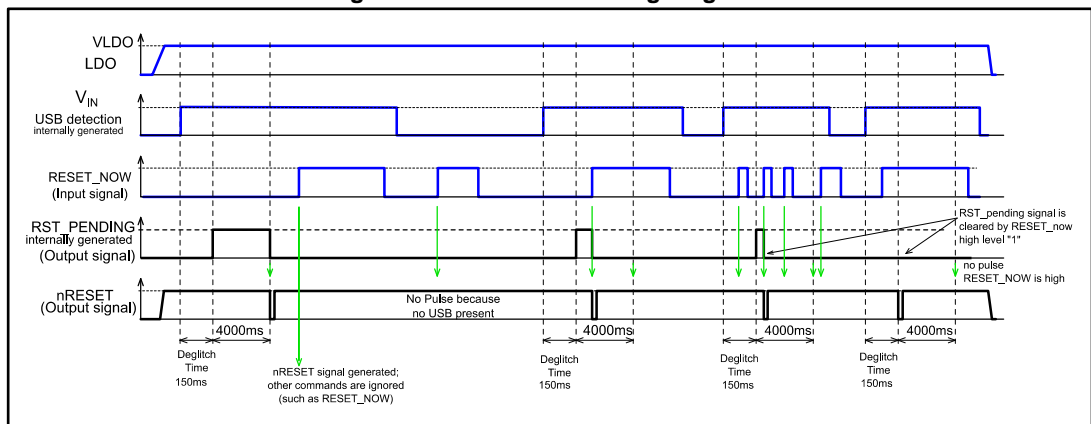

The nRESET pull-up resistor must be connected to LDO pin or to a higher voltage.

If not used, it is recommended both the nRESET and the RESET_NOW pins are pulled down via a 100 kΩ resistor connected to GND.

6.13.2 Watchdog section control pins

The watchdog functionality can be enabled or disabled by using SWIRE commands (#27 enabled, #26 disabled).

If enabled by asserting the SWIRE command, the RESET_CLEAR function, implemented using the RESET_NOW pin, allows the nRESET pulses to be skipped when in a high logic level state.

It is recommended a proper RESET_CLEAR signal is applied at least 100 μs before the next scheduled nReset transition to a low level (it occurs every 4000 ms).

Should the watchdog function be enabled at least after having detected a valid VIN plus a delay of 150 ms, an nRESET signal transitioning to a low level occurs after 4000 ms starting from the RST_PENDING transitioning to a high level. To skip this nRESET pulse, a high level RESET_CLEAR signal must be generated prior to (at least 100 μs) the expiration of the 4000 ms counter triggered by the RST_PENDING transitioning to a high level.

The watchdog function can be disabled anytime through an SWIRE command (#26) and if so, the relevant circuit block goes back to the smart reset functionality default state. For more details refer to the following timing diagram.

The watchdog function works when the STBC02 is in battery mode too.

Figure 20: Watchdog timing diagram

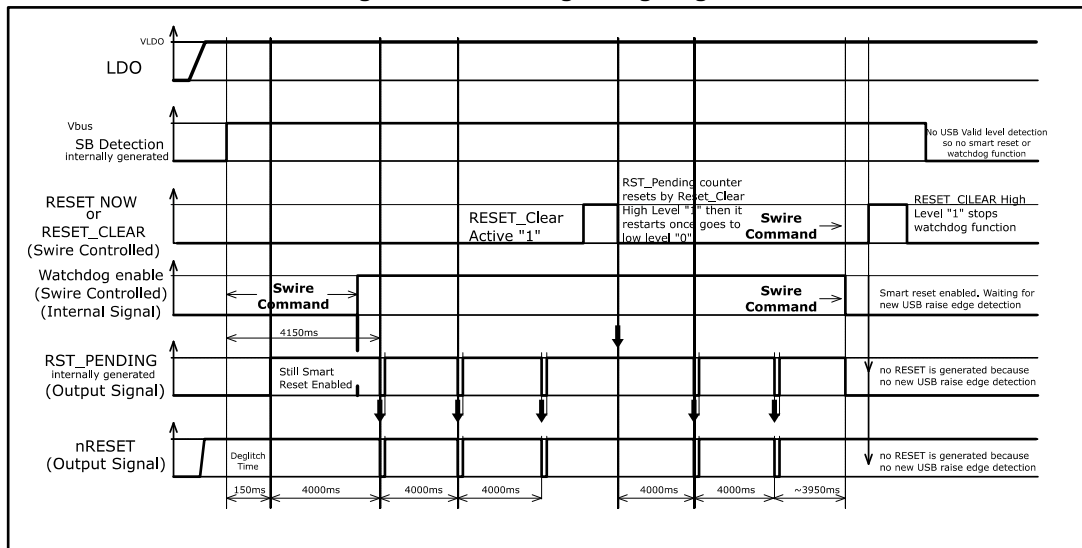

6.14 SW1_OA, SW1_OB, SW1_I, SW2_OA, SW2_OB, SW2_I

SPDT load switches pins. Both of SPDT load switches are controlled by an internal register, using the SWIRE interface. Each SPDT features a typical R_{DS(on)} of 3 Ω. SPDT load switches can be paralleled to reduce the series resistor as well as to increase the allowable flowing current.

6.15 SW_SEL

SW_SEL, serial SWIRE input pin. It is internally pulled down with a 500 kΩ resistor. In idle state the SW_SEL pin must be held to ground. See table below for details.

Table 9: SWIRE programming

SW_SEL pulse number	Function	Status	Note
Power-on	SW1_OA, SW2_OA	ON (default)	SW1_I is connected with SW1_OA and SW2_I is connected with SW2_OA
	SW1_OB, SW2_OB	OFF (default)	SW1_OB and SW2_OB are in high impedance (Hi-Z)
1	SW1_OA	to OFF	
2		to ON	
3	SW1_OB	to OFF	
4		to ON	
5	SW2_OA	to OFF	
6		to ON	
7	SW2_OB	to OFF	
8		to ON	
9	BATMS	BATMS OFF	Battery monitor switch (default value)
10		BATMS ON	It increases battery leakage due to external resistor divider R_{DIV1} , R_{DIV2}
11	I _{END}	I _{END} OFF	It disables EOC (end-of-charge signal). Charger continues working even if I _{END} is reached
12		I _{END} 5% I _{FAST} (default)	I _{END} stops the charger phase (default)
13		I _{END} 2.5% I _{FAST}	I _{END} stops the charger phase
14	I _{BAT} OCP	900 mA	Overcurrent protection (battery discharge). Default value
15		450 mA	
16		250 mA	
17		100 mA	
18	V _{FLOAT} adjustment	OFF	Default value
19		+50 mV	V _{FLOAT} increases 50 mV (whatever the programmed value is)
20		+100 mV	V _{FLOAT} increases 100 mV (whatever the programmed value is)
21		+150 mV	V _{FLOAT} increases 150 mV (whatever the programmed value is)
22		+200 mV	V _{FLOAT} increases 200 mV (whatever the programmed value is)

SW_SEL pulse number	Function	Status	Note
23	Shipping mode	ON	Forces the device in shutdown (low power mode)
24	Auto-recharge	OFF	Default value
25		ON	Charger restart. After end-of-charge if battery voltage crosses V_{REC} and t_{CRDD} expires, another charging cycle starts automatically
26	Watchdog	OFF	Smart reset (default)
27		ON	Watchdog enabled. RESET_NOW becomes RESET_CLEAR which allows recurring nRESET pulses to be skipped
28	I _{FAST} and I _{PRE} always 50%	OFF	I _{PRE} and I _{FAST} current as programmed by R _{PRE} and R _{SET} resistors (default)
29		ON	Forces I _{FAST} and I _{PRE} currents to be 50% of the initial programmed value. In case of thermal warning, the internal logic temporarily forces this bit "ON"

Figure 21: Single wire programming (SW_SEL INPUT)

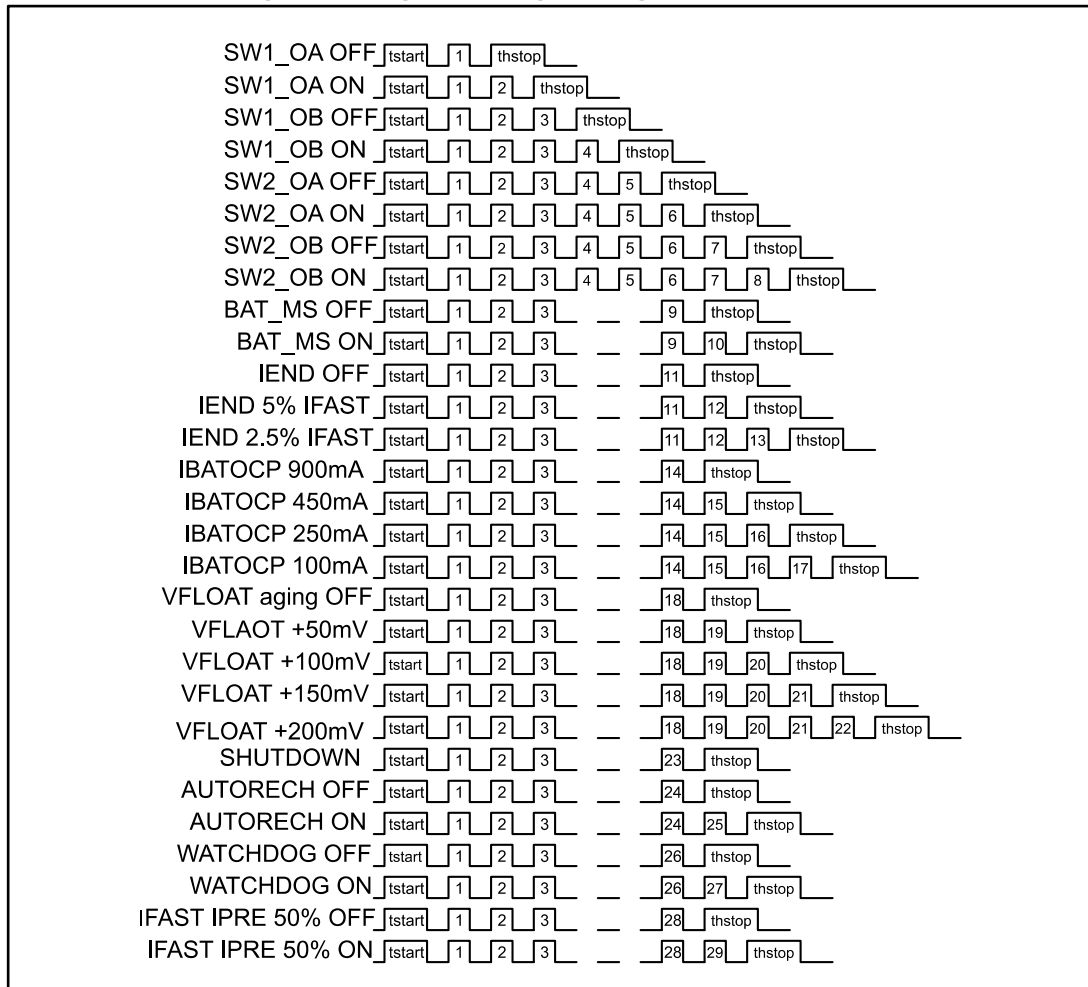
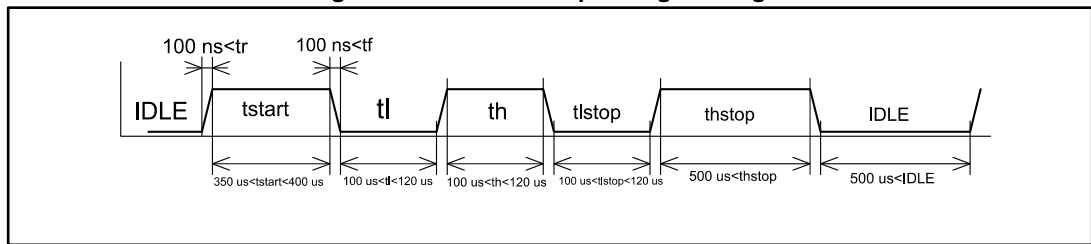

Figure 22: Start and stop timing bit range



Recommended SWIRE programming pulse width is 100 μs minimum, 120 μs maximum.

Start bit timing ranges between 350 μs and 400 μs .

Stop bit timing value $\geq 500\text{ }\mu\text{s}$.

7 Block diagram

Figure 23: STBC02 block diagram

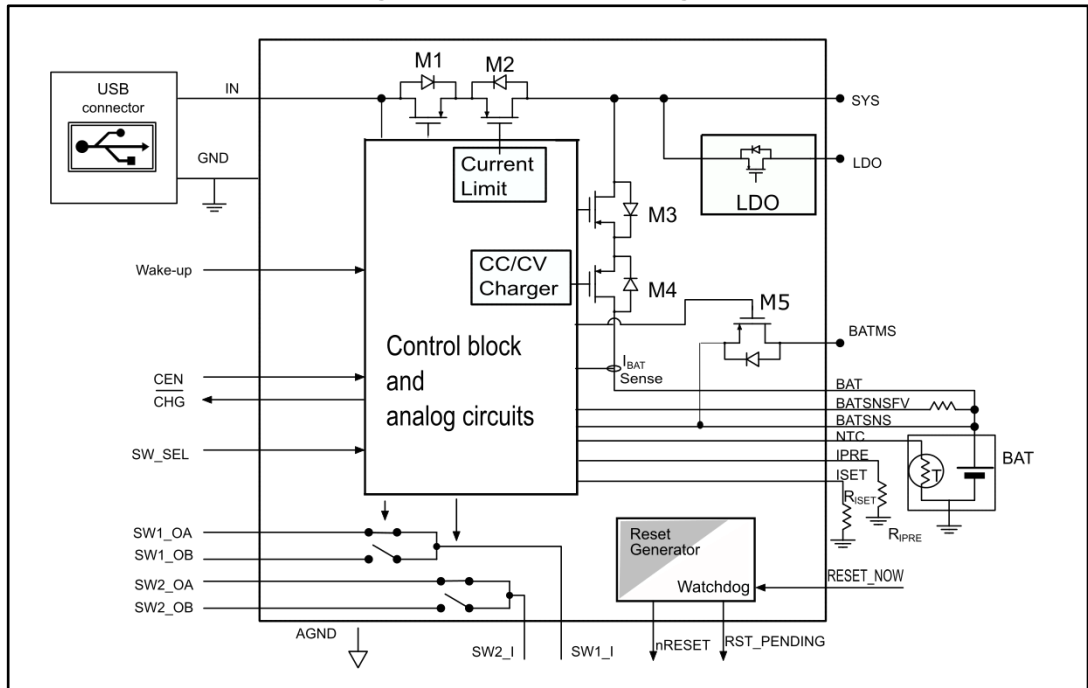

8 Operation description

The STBC02 is a power management IC integrating a battery charger with an embedded power path function, a 150 mA low quiescent LDO, a smart reset/watchdog, two SPDT load switches and a protection circuit module (PCM) to prevent the battery from being damaged.

When powered off from a single-cell Li-Ion or Li-Poly battery, and after having performed all the safety checks, the STBC02 starts charging the battery using a constant-current and constant-voltage algorithm.

The embedded power path allows simultaneously the battery to be charged and the overall system to be supplied.

By contrast, when the input voltage is outside the above valid range, the battery supplies the LDO as well as every load connected to SYS.

The STBC02 also protects the battery in case of:

- Overcharge
- Over-discharge
- Charge overcurrent
- Discharge overcurrent

If a fault condition is detected when the input voltage is valid ($V_{UVLO} < V_{IN} < V_{INOVP}$), the CHG pin starts toggling, signaling the fault.

The device can also be in shutdown mode (shutdown $I_{BAT} < 100$ nA) maximizing the battery life of the end-product during its shelf life.

8.1 Power-on

When the STBC02 is in shutdown mode, any load connected to LDO and to SYS is not supplied.

An applied valid input voltage ($V_{UVLO} < V_{IN} < V_{INOVP}$) for at least 250 ms, regardless the presence of a battery or if the battery is fully depleted, allows the loads connected to SYS and LDO to be supplied, thus enabling proper system operations.

The CEN pin must be left floating or tied high (LDO level) during the power-on for proper operations. The STBC02 can be also turned on when V_{IN} is outside the valid range, below the conditions that the battery has at least a remaining charge of 3 V and the wake-up input is properly triggered. The STBC02 features an UVLO circuit that prevents oscillations if the input voltage source is unstable. The CEN pin must be left floating or tied to a high level (LDO) when the STBC02 is powered.

8.2 Battery charger

The STBC02 allows single-cell Li-Ion and Li-Poly battery chemistry to be charged up to a 4.45 V using a CC/CV charging algorithm. The charging cycle starts when a valid input voltage source ($V_{UVLO} < V_{IN} < V_{INOVP}$) is detected and signaled by the CHG pin toggling from a high impedance state to a low logic level.

If the battery is deeply discharged (the battery voltage is lower than V_{PRE}), the STBC02 charger enters the pre-charge phase and starts charging in constant-current mode with the pre-charge current (I_{PRE}) set. In case the battery voltage does not reach the V_{PRE} threshold within the t_{PRE} time, the charging process is stopped and a fault is signaled.

By contrast, as soon as the battery voltage reaches the V_{PRE} threshold, the constant-current fast charge phase starts operating, and the relevant charging current increases to the I_{FAST} level.

Likewise, if the constant current fast charge phase is not completed within t_{FAST} , meaning that $V_{BAT} < V_{FLOAT}$, the charging process is stopped and a fault is signaled (CHG starts toggling at 10.2 Hz as long as a valid V_{IN} is present).

Should the battery voltage decrease below V_{PRE} during the fast charge phase, the charging process is halted and a fault is signaled. The constant-current fast charge phase lasts until the battery voltage is lower than V_{FLOAT} . After that, the charging algorithm switches to a constant-voltage (CV) mode.

During the CV mode, the battery voltage is regulated to V_{FLOAT} and the charging current starts decreasing over time. As soon as it goes below I_{END} , the charging process is considered to be completed (EOC, end-of-charge) and the relevant status is signaled via a 4.1 Hz toggling signal on the CHG pin, again as long as there is a valid input source applied ($V_{UVLO} < V_{IN} < V_{INOVP}$).

Both I_{PRE} and the I_{FAST} values can be programmed from 1 mA to 450 mA via an external resistor, as described in the ISET pin description.

For any I_{FAST} programmed value above 20 mA, the I_{END} value can be set either 5% or 2.5% of the I_{FAST} level.

For any I_{FAST} programmed value below 20 mA, the relevant I_{END} value is set as per the following table:

Table 10: I_{FAST} and I_{END}

I_{FAST}	I_{END}
20 mA	1.7 mA
10 mA	1.1 mA
5 mA	0.65 mA
2 mA	0.4 mA
1 mA	0.2 mA

The battery temperature is monitored throughout the charging cycle for safety reasons.

Figure 24: Charging flowchart

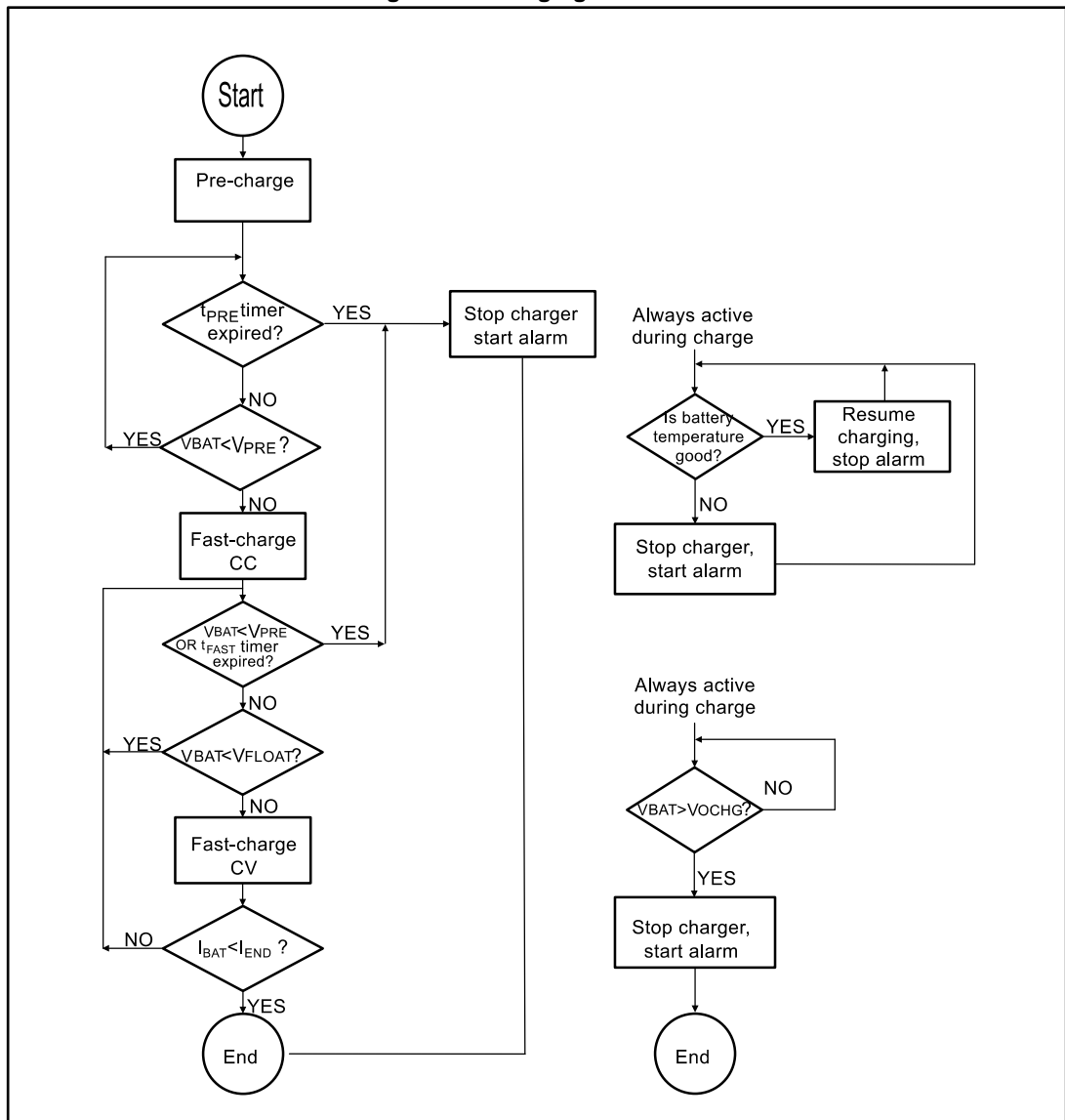

Actions:

- Pre-charge starts t_{PRE} timer; starts charging in CC mode at I_{PRE}
- Fast-charge CC starts t_{FAST} timer, increases charge current to I_{FAST}
- Fast-charge CV activates the constant-voltage control loop
- Start alarm: the CHG pin starts toggling

Figure 25: End-of-charge flowchart

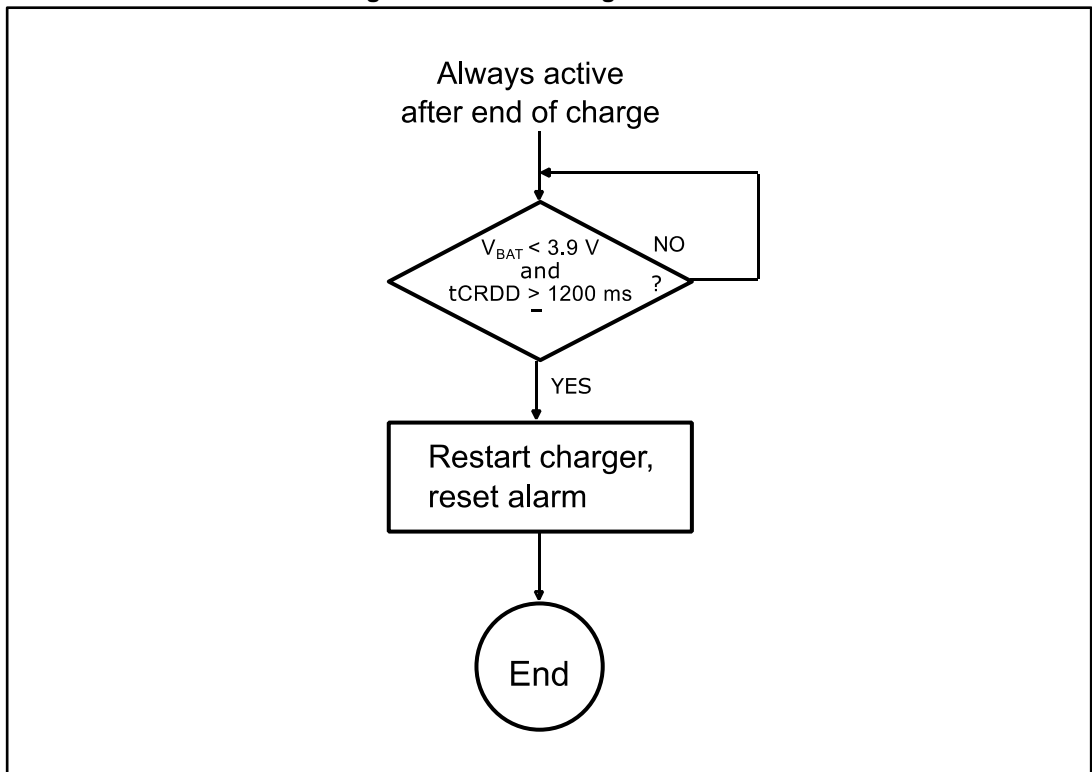
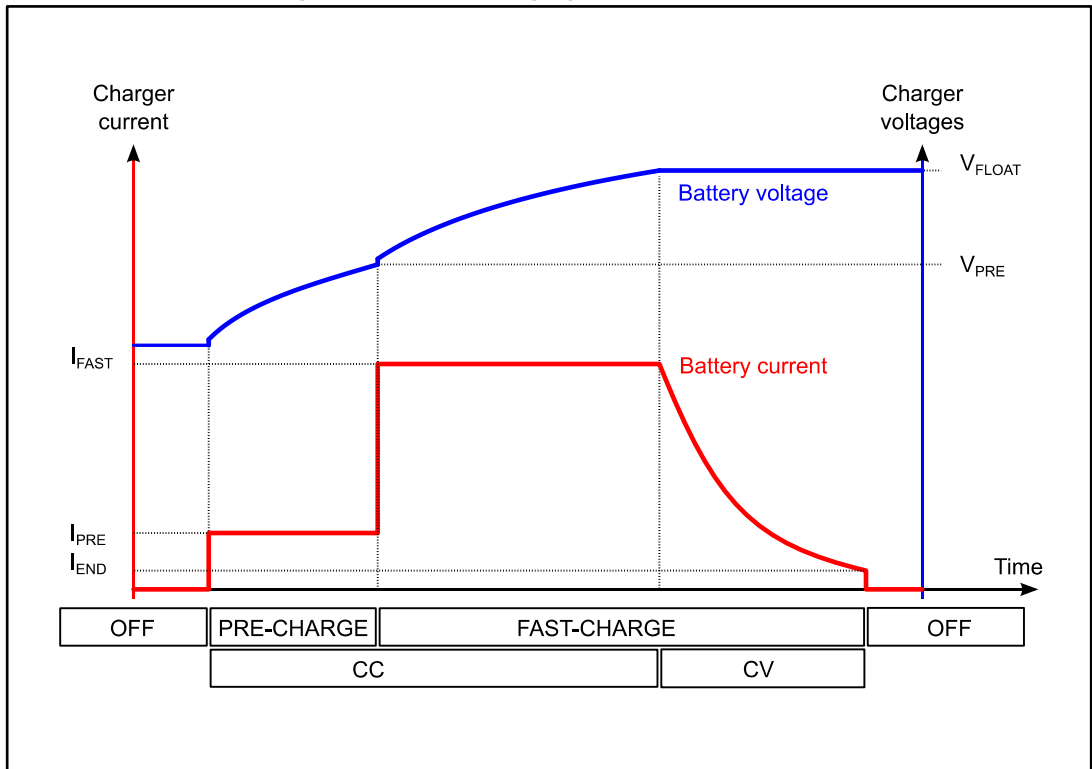

Figure 26: CC/CV charging profile (not in scale)



8.3 Battery temperature monitoring

The STBC02 integrates all the needed blocks to monitor the battery temperature through an external NTC resistor. The battery temperature monitoring is enabled only during the battery charging process, in order to save power when the system is supplied from the battery.

When the battery temperature is outside the normal operating range (0-45 °C), the charging process is halted, an alarm signal is activated (the CHG pin toggles at 16.2 Hz) but the charging timeout timers are not stopped.

If the temperature goes back to the normal operating range, before the maximum charging time has elapsed, the charging process is resumed and the alarm signal is cleared.

In case of the charging timeout expires and the temperature is still outside the normal operating range, the charging process is stopped but it can be still restarted using the CEN pin.

Both temperature thresholds feature a 3 °C hysteresis. The battery temperature monitoring block is designed to work with an NTC thermistor having $R_{25} = 10 \text{ k}\Omega$ and $\beta = 3370$ (Mitsubishi TH05-3H103F). If an NTC thermistor is not used, 10 k Ω resistor must be connected to ensure the proper IC operation.

8.4 Battery overcharge protection

The battery overcharge protection is a safety feature, active when a valid input voltage is connected, preventing the battery voltage from exceeding a V_{OCHG} value. Should an overcharge condition be detected, the current path from the input to the battery is opened and a fault signal is activated (the CHG pin toggles at 8.2 Hz). When the battery voltage goes below V_{OCHG} , normal operations can only be restarted by disconnecting and connecting back again the input voltage (V_{IN}).

8.5 Battery over-discharge protection

The battery over-discharge protection is a safety feature enabled only when no valid input voltage source ($V_{UVLO} < V_{IN} < V_{INOVP}$) is detected. Therefore, when the STBC02 and the system are powered off from the battery, an over-discharge of the battery itself is avoided. Should the battery voltage level be below V_{ODC} for more than t_{ODD} (over-discharge state), the STBC02 turns off and current sunk from the battery is reduced to less than 50 nA.

When a valid input voltage source is detected, while the battery is in an over-discharge state, the STBC02 charger, SYS and LDO outputs are enabled. This condition persists until the battery voltage has exceeded the over-discharge released threshold (V_{ODCR}), otherwise any other disconnection of a valid input voltage source brings back the STBC02 to a battery over-discharge state.

8.6 Battery discharge overcurrent protection

When the STBC02 is powered off from the battery connected to the BAT pin, a discharge overcurrent protection circuit disables the STBC02 if the current sunk from the battery is in excess of I_{BATOCF} (whose value is programmable via SWIRE) for more than t_{DOD} .

The presence of a valid input voltage source or triggering the WAKE-UP input pin, allows normal operating conditions to be restored.

8.7 Battery fault protection

The STBC02 features a battery fault protection. The STBC02 charger is stopped if the battery voltage remains below 1 V for at least 16 seconds.

8.8 Floating voltage adjustment

The STBC02 features a floating voltage adjustment, controlled via SWIRE, allowing the battery floating voltage (four steps of 50 mV each) to be changed. Due to multiple battery charging processes and the aging of the battery, the floating voltage of the battery can change and be reduced. The floating voltage adjustment feature brings the floating voltage level back to the original nominal value. For safety reasons, the battery voltage overcharge threshold level (V_{OCHG}) is linked to any floating voltage set. By default this feature is disabled and moreover, as no state is stored in any memory, every shutdown or shipping mode event resets the floating voltage at the default value.

8.9 Input overcurrent protection

When the STBC02 is powered off from a valid input voltage source, a current limitation circuit prevents the input current from increasing in an uncontrolled manner in case of excessive load. In fact, when V_{SYS} is lower than $V_{ILIMSCTH}$, the input current is limited so to have a reduced power dissipation. As soon as V_{SYS} increases over $V_{ILIMSCTH}$, the input current limit value is increased to I_{INLIM} .

8.10 SYS short-circuit protection, LDO current limitation

In battery mode condition, if a short-circuit on the SYS pin happens, the STBC02 is turned off (no deglitch). This short-circuit protection occurs until the SYS voltage drops below V_{SCSYS} .

If the LDO output is in a short-circuit condition, the maximum delivered current is limited to I_{sc} .

8.11 IN overvoltage protection

Should the input voltage source temporarily be $V_{IN} > V_{INOVP}$ (for example due to a poorly regulated voltage source), then the STBC02 is powered off from the battery, thus any load connected to SYS is protected.

As soon as the input voltage source goes back within a valid input range ($V_{UVLO} < V_{IN} < V_{INOVP}$), the STBC02 is then powered off again from V_{IN} .

8.12 Shutdown mode

A proper SWIRE sequence forces the STBC02 to enter in shutdown mode (low power); the current sunk from the battery is reduced to less than 50 nA. Both SYS and LDO pins are not supplied. Normal operating condition is restored either by connecting a valid input voltage source ($V_{UVLO} < V_{IN} < V_{INOVP}$) for at least t_{PW-VIN} or by connecting the WAKE-UP pin to V_{BAT} for at least t_{PW-WA} .

8.13 Watchdog function

The watchdog function can be enabled by SWIRE commands (#27 enabled, #26 disabled). The watchdog pulse is generated on nRESET pin.

8.14 Thermal shutdown

The STBC02 is fully protected against overheating. During the charging process, if a $T_{WRN} < T_{SD}$ temperature level is detected, a warning is signaled via the CHG output (toggling at 14.2 Hz). When in this condition, the programmed I_{PRE} and I_{FAST} are temporary halved. In case of a further temperature increase (up to T_{SD}) the STBC02 turns off, thus stopping the charging process. This condition is latched and normal operation can be

restored only by disconnecting and reconnecting back again a valid input voltage source on the V_{IN} pin.

8.15 Reverse current protection

When the input voltage (V_{IN}) is higher than V_{UVLO} , but lower than the battery voltage V_{BAT} ($V_{UVLO} < V_{IN} < V_{BAT}$) the current path from BAT to IN is opened so to stop any reverse current flowing from the battery to the input voltage source. This event is signaled through the CHG flag.

9 Package information

In order to meet environmental requirements, ST offers these devices in different grades of ECOPACK® packages, depending on their level of environmental compliance. ECOPACK® specifications, grade definitions and product status are available at: www.st.com. ECOPACK® is an ST trademark.

9.1 Flip Chip30 (2.59x2.25 mm) package information

Figure 27: Flip Chip 30 (2.59x2.25 mm) package outline

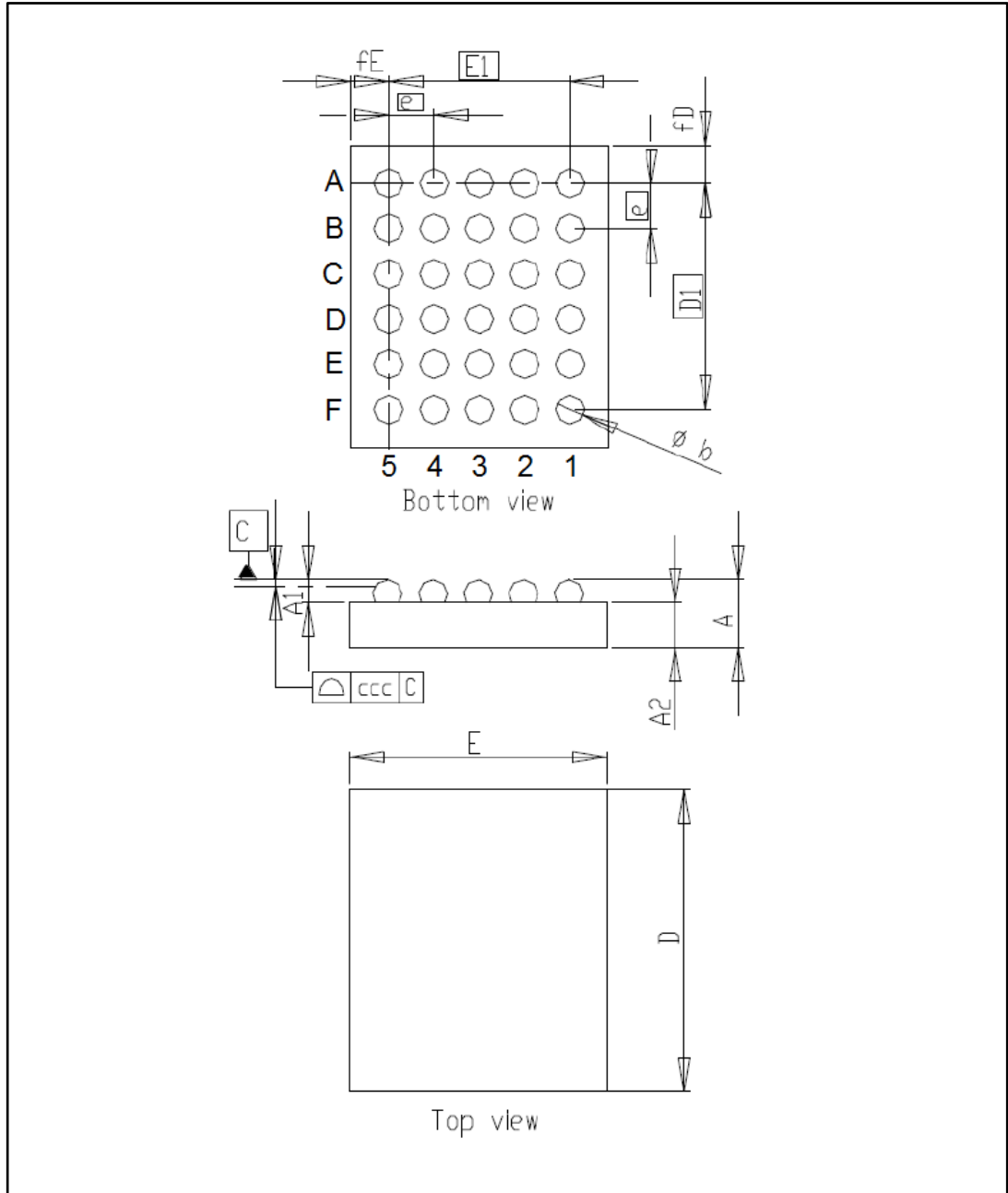

Table 11: Flip Chip 30 (2.59x2.25 mm) package mechanical data

Dim.	mm		
	Min.	Typ.	Max.
A	0.50	0.55	0.60
A1	0.17	0.20	0.23
A2	0.33	0.35	0.37
b	0.23	0.26	0.29
D	2.56	2.59	2.62
D1		2	
E	2.22	2.25	2.28
E1		1.6	
e		0.40	
SE		0.20	
SD		0.20	
fD	0.285	0.295	0.305
fE	0.315	0.325	0.335
ccc		0.075	



The terminal A1 on the bumps side is identified by a distinguishing feature (for instance by a circular "clear area", typically 0.1 mm diameter) and/or a missing bump. The terminal A1 on the backside of the product is identified by a distinguishing feature (for instance by a circular "clear area", typically between 0.1 and 0.5 mm diameter, depending on the die size).

Figure 28: Flip Chip 30 (2.59x2.25 mm) recommended footprint

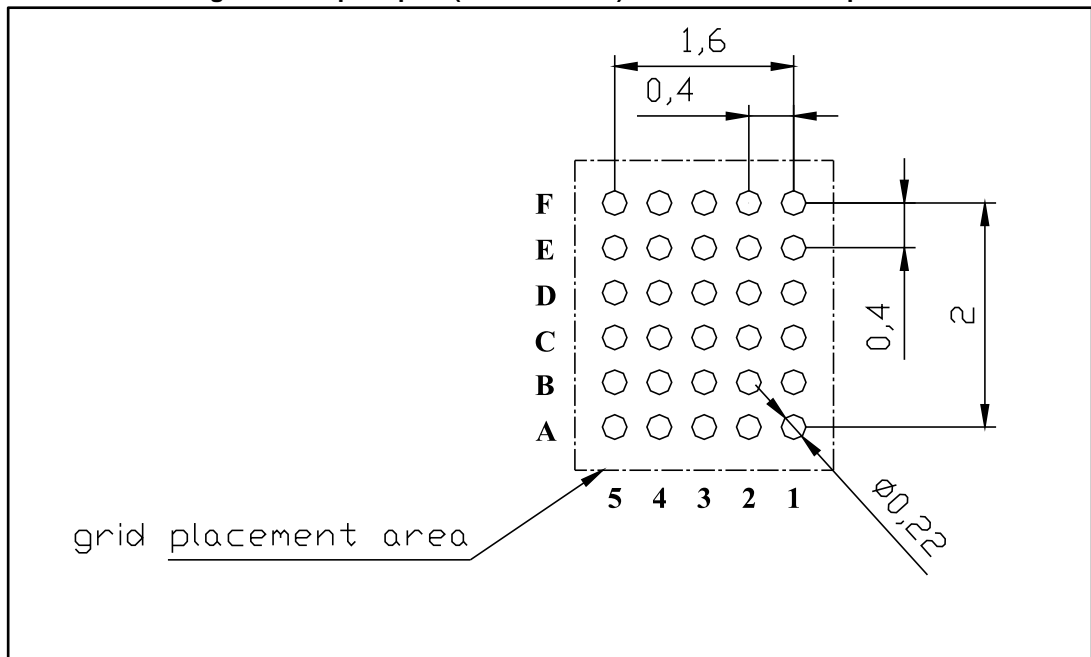

10 Ordering information

Table 12: Ordering information

Order code	LDO [V]	Control	Package
STBC02JR	3.0 V	SWIRE	Flip Chip 30 400 um pitch
STBC02BJR	3.1 V		
STBC02AJR	3.3 V		

11 Revision history

Table 13: Document revision history

Date	Revision	Changes
17-May-2016	1	Initial release.
02-Dec-2016	2	Updated Table 3: "Absolute maximum ratings" and Table 5: "Electrical characteristics" .

IMPORTANT NOTICE – PLEASE READ CAREFULLY

STMicroelectronics NV and its subsidiaries ("ST") reserve the right to make changes, corrections, enhancements, modifications, and improvements to ST products and/or to this document at any time without notice. Purchasers should obtain the latest relevant information on ST products before placing orders. ST products are sold pursuant to ST's terms and conditions of sale in place at the time of order acknowledgement.

Purchasers are solely responsible for the choice, selection, and use of ST products and ST assumes no liability for application assistance or the design of Purchasers' products.

No license, express or implied, to any intellectual property right is granted by ST herein.

Resale of ST products with provisions different from the information set forth herein shall void any warranty granted by ST for such product.

ST and the ST logo are trademarks of ST. All other product or service names are the property of their respective owners.

Information in this document supersedes and replaces information previously supplied in any prior versions of this document.

© 2016 STMicroelectronics – All rights reserved