

## High temperature 40 A SCRs

Datasheet - production data

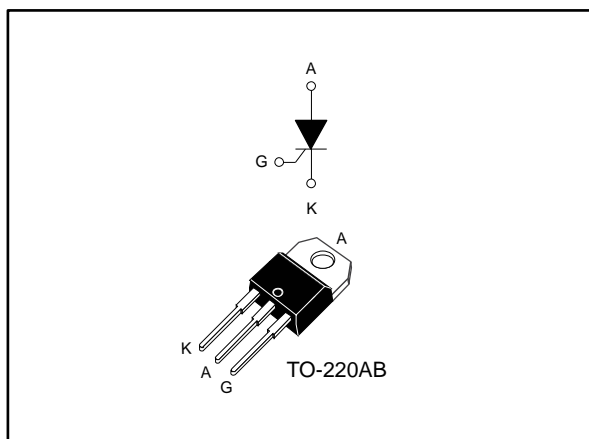

### Features

- High junction temperature :  $T_j = 150\text{ °C}$
- High noise immunity  $dV/dt = 500\text{ V}/\mu\text{s}$  up to  $150\text{ °C}$
- Gate triggering current  $I_{GT} = 15\text{ mA}$
- Off-state voltage  $600\text{ V } V_{DRM}/V_{RRM}$
- High turn on current rise  $dI/dt = 100\text{ A}/\mu\text{s}$
- ECOPACK<sup>®</sup>2 compliant component

### Applications

- Motorbike voltage regulator circuits
- Inrush current limiting circuit
- Motor control circuits and starters
- Solid state relays

### Description

The TN4015H-6T in non-isolated TO-220AB package offers high thermal performances up to 40 A, thanks to its junction temperature up to  $150\text{ °C}$ .

Its trade-off noise immunity ( $dV/dt = 500\text{ V}/\mu\text{s}$ ) versus its gate triggering current ( $I_{GT} = 15\text{ mA}$ ) and its turn-on current rise ( $dI/dt = 100\text{ A}/\mu\text{s}$ ) allows to design robust and compact control circuit for voltage regulator in motorbikes and industrial drives, overvoltage crowbar protection, motor control circuits in power tools and kitchen aids, inrush current limiting circuits.

**Table 1: Device summary**

| Order code | Package  | $V_{DRM}/V_{RRM}$ | $I_{GT}$ |
|------------|----------|-------------------|----------|
| TN4015H-6T | TO-220AB | 600 V             | 15 mA    |

# 1 Characteristics

**Table 2: Absolute maximum ratings (limiting values),  $T_j = 25\text{ °C}$  unless otherwise specified**

| Symbol            | Parameter   |                         | Value                 | Unit                    |             |
|-------------------|---|-------------------------|-----------------------|-------------------------|-------------|
| $I_{T(RMS)}$      | RMS on-state current (180 ° conduction angle)   |                         | $T_c = 119\text{ °C}$ | 40                      | A           |
| $I_{T(AV)}$       | Average on-state current (180 ° conduction angle)   |                         | $T_c = 120\text{ °C}$ | 25                      | A           |
|                   |   |                         | $T_c = 125\text{ °C}$ | 22                      |             |
|                   |   |                         | $T_c = 128\text{ °C}$ | 20                      |             |
| $I_{TSM}$         | Non repetitive surge peak on-state current  |                         | $t_p = 8.3\text{ ms}$ | 394                     | A           |
|                   |   |                         | $t_p = 10\text{ ms}$  | 360                     |             |
| $I^2t$            | $I^2t$ value for fusing   |                         | $t_p = 10\text{ ms}$  | 648                     | $A^2s$      |
| $di/dt$           | Critical rate of rise of on-state current<br>$I_G = 2 \times I_{GT}$ , $t_r \leq 100\text{ ns}$ |                         | $f = 60\text{ Hz}$    | 100                     | $A/\mu s$   |
| $V_{DRM}/V_{RRM}$ | Repetitive peak off-state voltage   |                         | $T_j = 150\text{ °C}$ | 600                     | V           |
| $V_{DSM}/V_{RSM}$ | Non repetitive surge peak off-state voltage   |                         | $t_p = 10\text{ ms}$  | $V_{DRM}/V_{RRM} + 100$ | V           |
| $I_{GM}$          | Peak gate current   | $t_p = 20\text{ }\mu s$ | $T_j = 150\text{ °C}$ | 4                       | A           |
| $P_{G(AV)}$       | Average gate power dissipation  |                         | $T_j = 150\text{ °C}$ | 1                       | W           |
| $V_{RGM}$         | Maximum peak reverse gate voltage   |                         |                       | 5                       | V           |
| $T_{stg}$         | Storage junction temperature range  |                         |                       | -40 to +150             | $^{\circ}C$ |
| $T_j$             | Maximum operating junction temperature  |                         |                       | -40 to +150             | $^{\circ}C$ |
| $T_L$             | Maximum lead temperature soldering during 10 s  |                         |                       | 260                     | $^{\circ}C$ |

**Table 3: Electrical characteristics ( $T_j = 25\text{ °C}$  unless otherwise specified)**

| Symbol   | Test Conditions   |                       | Value | Unit |           |
|----------|---|-----------------------|-------|------|-----------|
| $I_{GT}$ | $V_D = 12\text{ V}$ , $R_L = 33\text{ }\Omega$  |                       | Max.  | 15   | mA        |
| $V_{GT}$ |   |                       | Max.  | 1.3  | V         |
| $V_{GD}$ | $V_D = V_{DRM}$ , $R_L = 3.3\text{ k}\Omega$  | $T_j = 150\text{ °C}$ | Min.  | 0.15 | V         |
| $I_H$    | $I_T = 500\text{ mA}$ , gate open   |                       | Max.  | 60   | mA        |
| $I_L$    | $I_G = 1.2 \times I_{GT}$   |                       | Max.  | 80   | mA        |
| $dV/dt$  | $V_D = 402\text{ V}$ , gate open  | $T_j = 150\text{ °C}$ | Min.  | 500  | $V/\mu s$ |
| $t_{gt}$ | $I_T = 80\text{ A}$ , $V_D = 600\text{ V}$ , $I_G = 100\text{ mA}$ , $(dI_G/dt)_{max} = 0.2\text{ A}/\mu s$                                 |                       | Typ.  | 1.9  | $\mu s$   |
| $t_q$    | $V_D = 402\text{ V}$ , $I_T = 40\text{ A}$ , $V_R = 25\text{ V}$ , $dV_D/dt = 50\text{ V}/\mu s$ ,<br>$(dI_G/dt)_{max} = 30\text{ A}/\mu s$ | $T_j = 150\text{ °C}$ | Typ.  | 85   | $\mu s$   |

Table 4: Static characteristics

| Symbol                | Test conditions                                   |                                    |      | Value | Unit          |
|-----------------------|---|------------------------------------|------|-------|---------------|
| $V_{TM}$              | $I_{TM} = 80 \text{ A}$ , $t_p = 380 \mu\text{s}$ | $T_j = 25 \text{ }^\circ\text{C}$  | Max. | 1.6   | V             |
| $V_{TO}$              | Threshold voltage                                 | $T_j = 150 \text{ }^\circ\text{C}$ | Max. | 0.85  |               |
| $R_D$                 | Dynamic resistance                                | $T_j = 150 \text{ }^\circ\text{C}$ | Max. | 10    | m $\Omega$    |
| $I_{DRM}$ , $I_{RRM}$ | $V_D = V_{DRM} = V_{RRM}$                         | $T_j = 25 \text{ }^\circ\text{C}$  | Max. | 10    | $\mu\text{A}$ |
|                       |   | $T_j = 150 \text{ }^\circ\text{C}$ |      | 6     | mA            |

Table 5: Thermal parameters

| Symbol        | Parameter                |      | Value | Unit               |
|---------------|--------------------------|------|-------|--------------------|
| $R_{th(j-c)}$ | Junction to case (DC)    | Max. | 0.8   | $^\circ\text{C/W}$ |
| $R_{th(j-a)}$ | Junction to ambient (DC) | Typ. | 60    |                    |

### 1.1 Characteristics (curves)

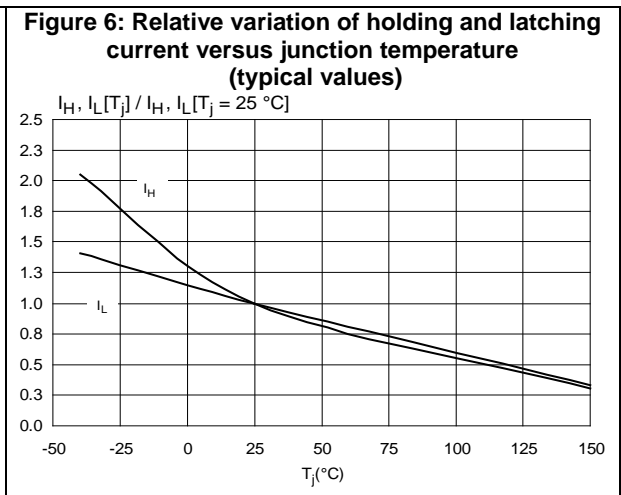
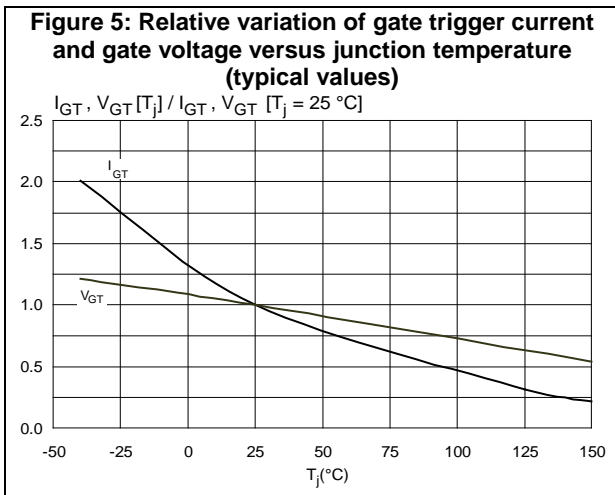
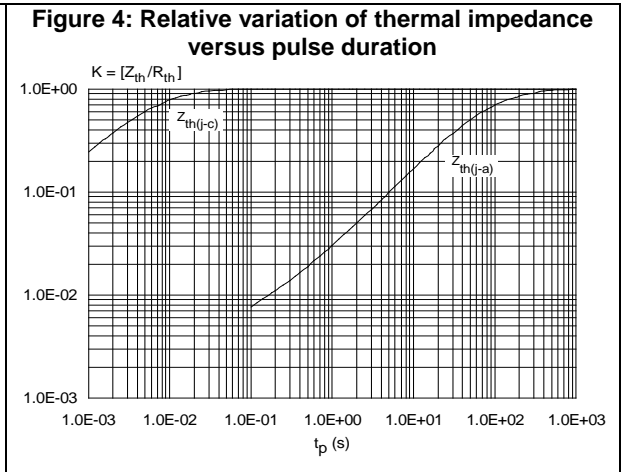
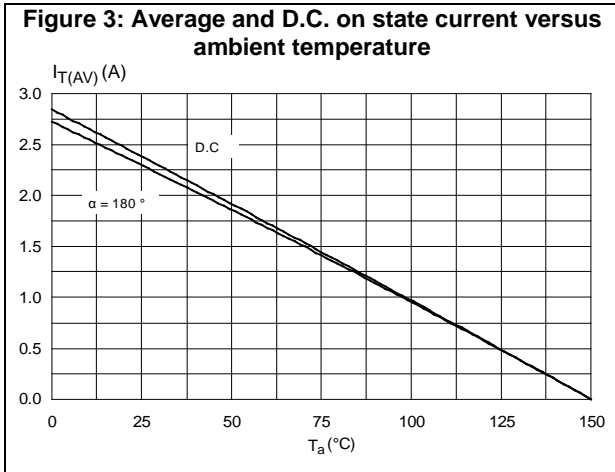
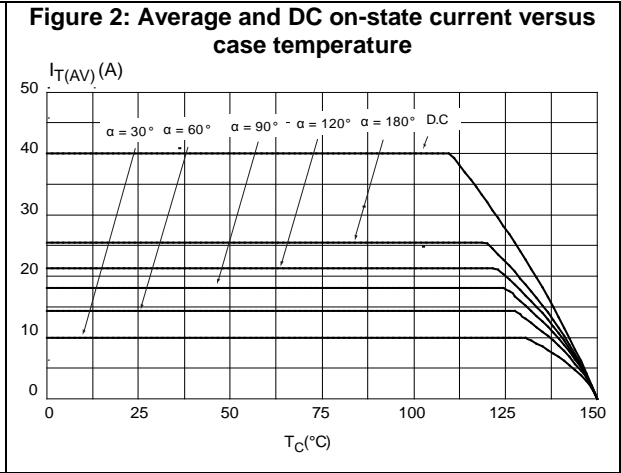
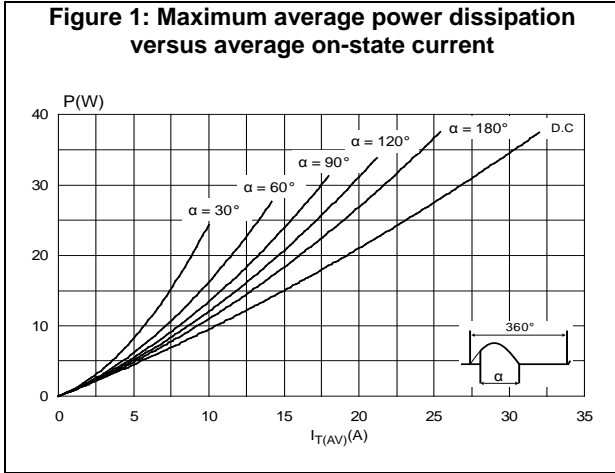

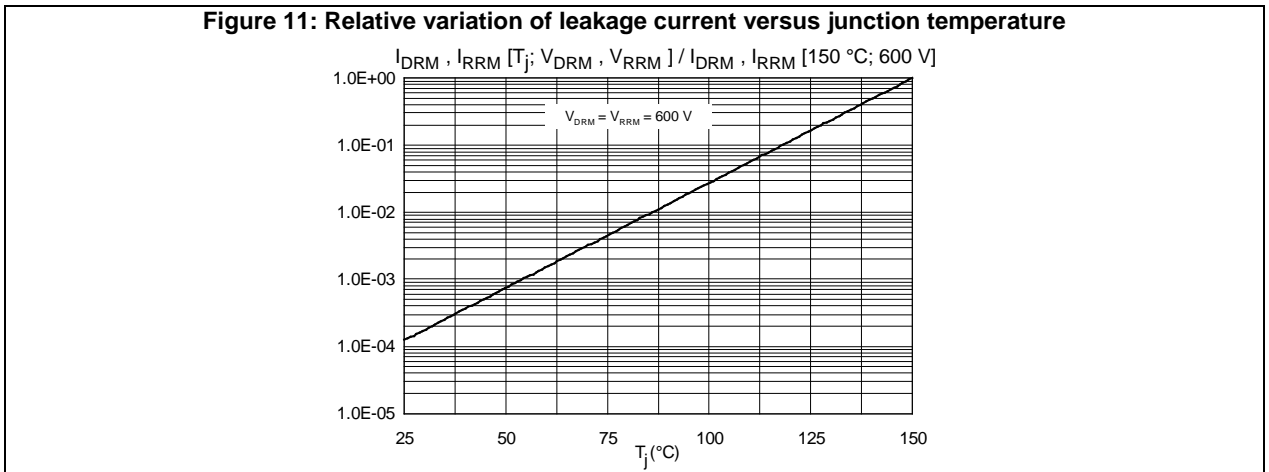
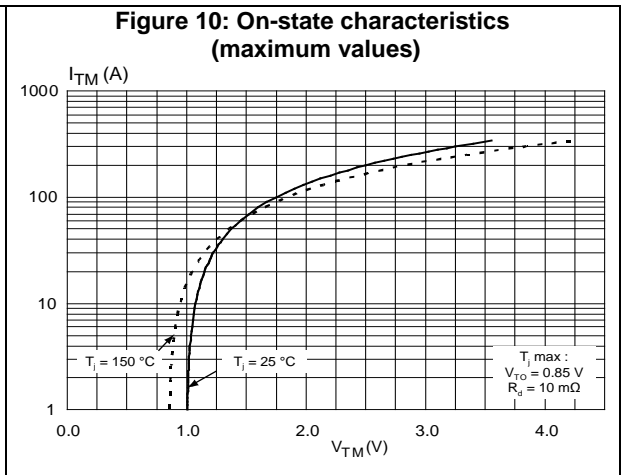
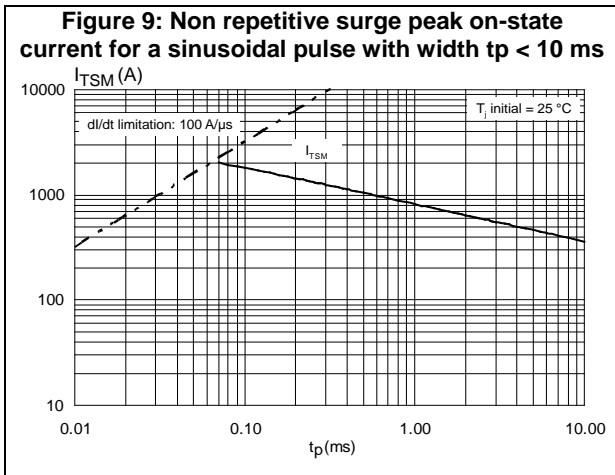
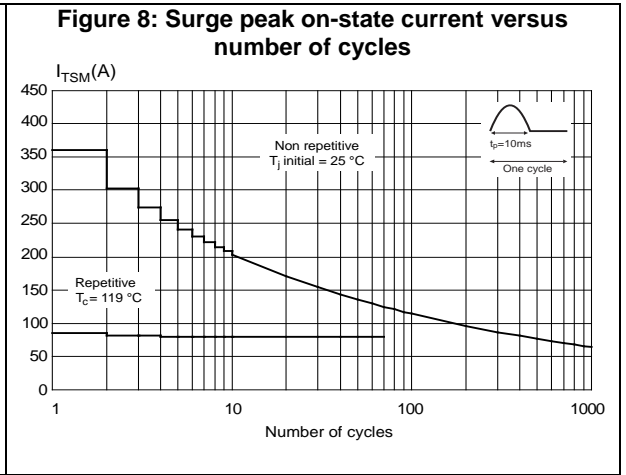
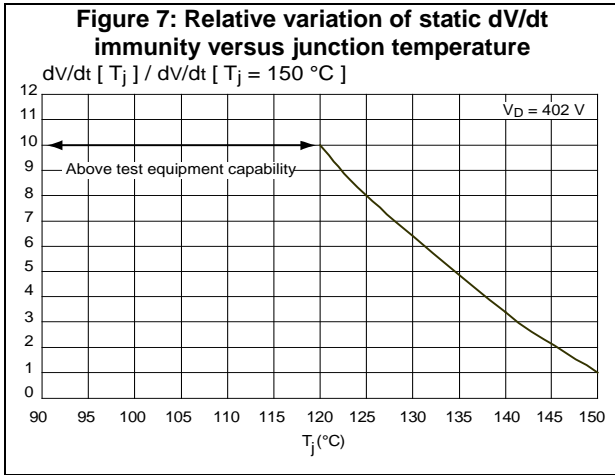

## 2 Package information

In order to meet environmental requirements, ST offers these devices in different grades of ECOPACK® packages, depending on their level of environmental compliance. ECOPACK® specifications, grade definitions and product status are available at: [www.st.com](http://www.st.com). ECOPACK® is an ST trademark.

- Epoxy meets UL94, V0
- Lead-free, halogen-free package

### 2.1 TO-220AB package information

Figure 12: TO-220AB package outline

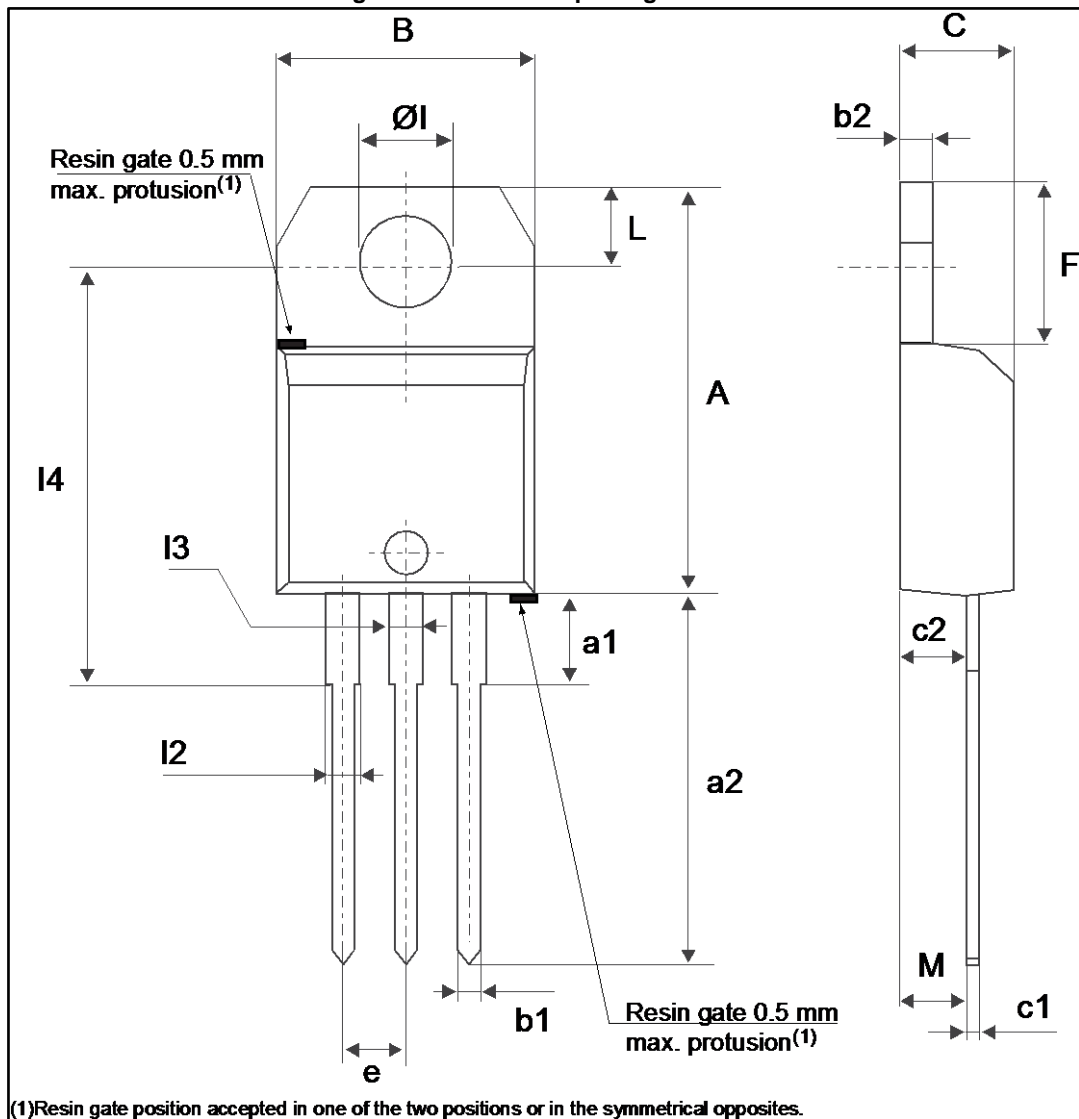

Table 6: TO-220AB package mechanical data

| Ref. | Dimensions  |       |       |        |        |        |
|------|-------------|-------|-------|--------|--------|--------|
|      | Millimeters |       |       | Inches |        |        |
|      | Min.        | Typ.  | Max.  | Min.   | Typ.   | Max.   |
| A    | 15.20       |       | 15.90 | 0.5984 |        | 0.6260 |
| a1   |             | 3.75  |       |        | 0.1476 |        |
| a2   | 13.00       |       | 14.00 | 0.5118 |        | 0.5512 |
| B    | 10.00       |       | 10.40 | 0.3937 |        | 0.4094 |
| b1   | 0.61        |       | 0.88  | 0.0240 |        | 0.0346 |
| b2   | 1.23        |       | 1.32  | 0.0484 |        | 0.0520 |
| C    | 4.40        |       | 4.60  | 0.1732 |        | 0.1811 |
| c1   | 0.49        |       | 0.70  | 0.0193 |        | 0.0276 |
| c2   | 2.40        |       | 2.72  | 0.0945 |        | 0.1071 |
| e    | 2.40        |       | 2.70  | 0.0945 |        | 0.1063 |
| F    | 6.20        |       | 6.60  | 0.2441 |        | 0.2598 |
| ØI   | 3.73        |       | 3.88  | 0.1469 |        | 0.1528 |
| I4   | 15.8        | 16.40 | 16.80 | 0.6220 | 0.6457 | 0.6614 |
| L    | 2.65        |       | 2.95  | 0.1043 |        | 0.1161 |
| I2   | 1.14        |       | 1.70  | 0.0449 |        | 0.0669 |
| I3   | 1.14        |       | 1.70  | 0.0449 |        | 0.0669 |
| M    |             | 2.60  |       |        | 0.1024 |        |

### 3 Ordering information

Figure 13: Ordering information scheme

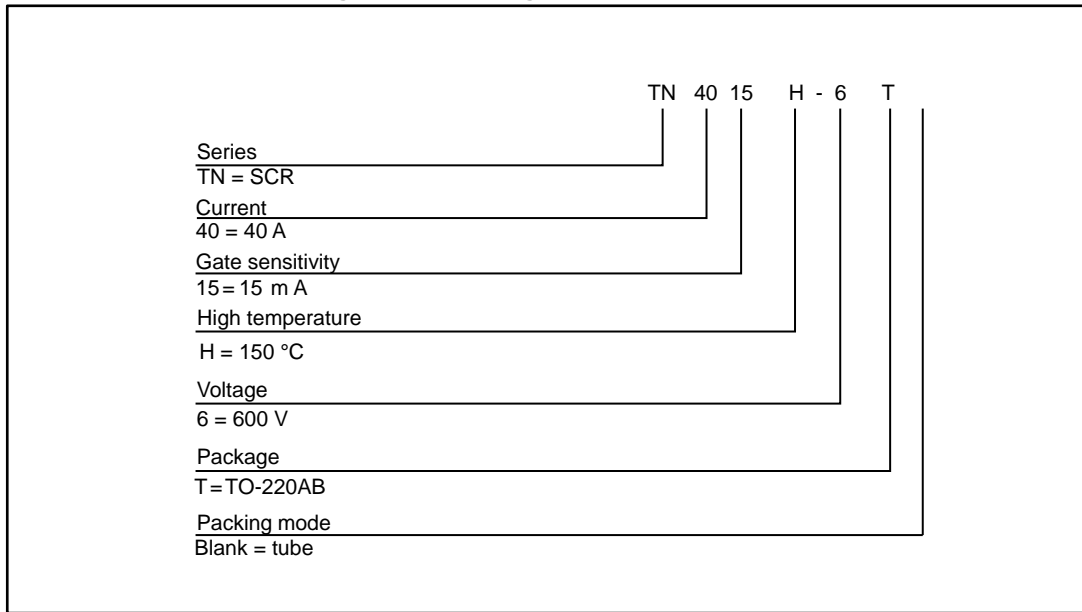

Table 7: Ordering information

| Order code | Marking  | Package  | Weight | Base qty. | Delivery mode |
|------------|----------|----------|--------|-----------|---------------|
| TN4015H-6T | TN4015H6 | TO-220AB | 2.3 g  | 50        | Tube          |

### 4 Revision history

Table 8: Document revision history

| Date        | Revision | Changes          |
|-------------|----------|------------------|
| 08-Sep-2016 | 1        | Initial release. |



**IMPORTANT NOTICE – PLEASE READ CAREFULLY**

STMicroelectronics NV and its subsidiaries ("ST") reserve the right to make changes, corrections, enhancements, modifications, and improvements to ST products and/or to this document at any time without notice. Purchasers should obtain the latest relevant information on ST products before placing orders. ST products are sold pursuant to ST's terms and conditions of sale in place at the time of order acknowledgement.

Purchasers are solely responsible for the choice, selection, and use of ST products and ST assumes no liability for application assistance or the design of Purchasers' products.

No license, express or implied, to any intellectual property right is granted by ST herein.

Resale of ST products with provisions different from the information set forth herein shall void any warranty granted by ST for such product.

ST and the ST logo are trademarks of ST. All other product or service names are the property of their respective owners.

Information in this document supersedes and replaces information previously supplied in any prior versions of this document.

© 2016 STMicroelectronics – All rights reserved