



Features

- Integrated Single fiber bi-directional optical subassembly
- 2x10 SFF pinout supports I²C digital diagnostics
- Voice/Data FTTx ONT/ONU Applications
- 1244 Mbps Tx, 2488 Mbps Rx Asymmetric Data Rate
- 1310 nm Tx, 1490 nm Rx
- Burst Mode Transmission
- Commercial temperature and Industrial temperature versions available
- 28 dB link budget; 20 km reach
- TX Burst Mode Detection, TX_SD
- Compliant to IEC-60825 Class 1 laser diode
- Compliant to FSAN G.984.2 ClassB+
- Compliant with SFF-8472 v10.3
- SC/APC fiber connector
- RoHS compliant
- Internal Calibration

Regulatory Compliance

Table 1 – Regulatory Compliance

Feature	Standard	Performance
Electrostatic Discharge (ESD) to the Electrical Pins	MIL-STD-883E Method 3015.7	Class 1(>500V for XFI pins, >2000V for other pins.)
Electrostatic Discharge (ESD) to the Duplex LC Receptacle	IEC 61000-4-2 GR-1089-CORE	Compatible with standards
Electromagnetic Interference (EMI)	FCC Part 15 Class B EN55022 Class B (CISPR 22B) VCCI Class B	Compatible with standards
Immunity	IEC 61000-4-3	Compatible with standards
Laser Eye Safety	FDA 21CFR 1040.10 and 1040.11 EN60950, EN (IEC) 60825-1,2	Compatible with Class I laser product.
RoHS	2002/95/EC 4.1&4.2 2005/747/EC	Compliant with standards ^{note}

Note:

In light of item 5 in Annex of 2002/95/EC, “Pb in the glass of cathode ray tubes, electronic components and fluorescent tubes.” and item 13 in Annex of 2005/747/EC, “Lead and cadmium in optical and filter glass.”, the two exemptions are being concerned for Source Photonics transceivers, because Source Photonics transceivers use glass, which may contain Pb, for components such as lenses, windows, isolators, and other electronic components.

Absolute Maximum Ratings

Table 2 – Absolute Maximum Ratings

Parameter	Symbol	Min.	Typical	Max.	Unit	Notes
Storage Temperature	T _s	-40	-	+85	°C	
Operating Relative Humidity	RH	10	-	90	%	
Lead Solder Temperature	T _{solder}	-	-	260	°C	
Supply Voltage	V _{cc_uC}	-0.3	-	4.2	V	
	V _{cc_Rx}	-0.3	-	4.2	V	
	V _{cc_Tx}	-0.3	-	V _{cc_Rx} + 1	V	
ESD Human Body Model	HBM	-	-	1000	V	

Recommended Operating Conditions

Table 3 – Recommended Operating Conditions

Parameter	Symbol	Min.	Typical	Max.	Unit	Notes
Operating Case Temperature (SFA-34-24T-HP-CDFJ)	T _c	0	-	70	°C	
Operating Case Temperature (SFA-34-24T-HP-TDFJ)	T _c	-40	-	+85	°C	
Operating Voltage	V _{CC}	3.14	3.30	3.46	V	
Total TX and RX Supply Current	I _{CC}	-	-	300	mA	
Power Dissipation	P _D	-	-	1.2	W	
Bit Rate(Tx)	BR	-	1244.16	-	Mbps	
Bit Rate(Rx)	BR	-	2488.32	-	Mbps	
Transmission Distance	TD	-	-	20,000	m	
Power supply noise rejection		-	-	100	mV p-p	
(1260-1360nm) to 1490 Rx Isolation		30	-	-	dB	
(1550-1560nm) Ext to 1490 Rx Isolation		34	-	-	dB	
(1260-1360nm) to 1490 Rx Optical Crosstalk		-	-	-47	dB	
Back Reflection @ 1310nm		-	-	-12	dB	
Back Reflection @ 1490nm		-	-	-27	dB	
Rx Reflectance		-	-	-20	dB	
1530nm to 1490nm Rx Isolation		7	-	-	dB	
1539nm to 1490nm Rx Isolation		22	-	-	dB	

Optical Characteristics

Table 4 – Optical Characteristics

Transmitter						
Parameter	Symbol	Min.	Typical	Max.	Unit	Notes
Center Wavelength Range	λ_C	1290	1310	1330	nm	
Average Output Power	P_{OUT}	0.5	-	5	dBm	
Average Output Power (Laser Off)	$P_{OUT-OFF}$	-	-	-45	dBm	
Spectral Width (-20dB)	λ_{20}	-	-	1	nm	
Extinction Ratio	ER	10	-	-	dB	1
Optical Rise/Fall Time (20%-80%)	T_R/T_F	-	-	250	ps	
SMSR	SMSR	30	-	-	dB	
Jitter Generation	JG	-	-	0.2	UI	2
Transmitter Output Eye	Compliant with G.984.2 Figure 3					
Receiver						
Center Wavelength Range	λ_C	1480	-	1500	nm	
Received Optical Power	P_{in}	-28	-	-8	dBm	3
Signal Detect Assertion Level	SDA	-	-	-28	dBm	
Signal Detect De-Assertion Level	SDD	-38	-	-	dBm	
Hysteresis	$P_{SDA-SDD}$	0.5	-	6	dB	
RSSI Accuracy	RSSI	-3	-	+3	dB	

Notes:

1. Measured with a PRBS $2^{23}-1$, NRZ, 50% duty cycle.
2. 4kHz to 10MHz
3. Measured with a PRBS $2^{31}-1$, 50% duty cycle.

Electrical Characteristics

Table 5 – Electrical Characteristics

Transmitter						
Parameter	Symbol	Min.	Typical	Max.	Unit	Notes
Differential Data Input Amplitude	$V_{IN,P-P}$	300	-	1600	mVpp	4
Input Differential Impedance	Z_{IN}	-	100	-	Ω	5
Tx_BRST Enable Time	T_{BURST_EN}	-	-	12.86	ns	6
Tx_BRST Disable Time	T_{BURST_DIS}	-	-	12.86	ns	6
Tx_BRST Voltage - Low	$V_{TX_ENB_LOW}$	0	-	0.8	V	
Tx_BRST Voltage – High	$V_{TX_ENB_HITH}$	2.0	-	Vcc	V	
TX_SD Delay (Timing “D”)	$T_{TX_SD_D}$	-	-	300	ns	7

TX_SD Width Difference (Timing "X")	$T_{TX_SD_X}$	-	-	100	ns	7
TX_SD Startup Time	$T_{TX_SD_STARTUP}$	-	-	300	ms	7
Receiver						
Differential Output Voltage		600	-	900	mV	8
Signal Detect Output HIGH Voltage	V_{SD_High}	2.4	-	-	V	9
Signal Detect Output LOW Voltage	V_{SD_Low}	-	-	0.6	V	10
Data Output Rise and Fall Time	T_R/T_F	-	-	160	ps	

Notes:

4. LVPECL input, DC coupled internally
5. TxD+/-.
6. 16 bits data @1244Mbps, refer to figure3.
7. TX_SD Timing Diagram:

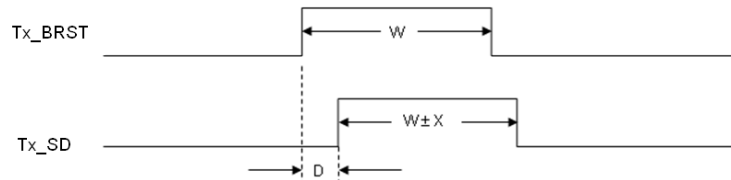

Figure 1, TX_SD Timing Diagram

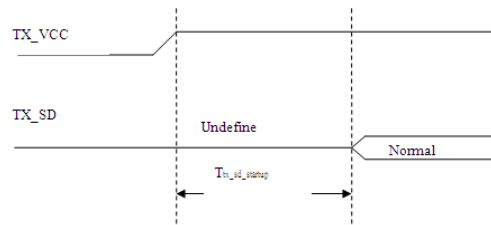

Figure 2, TX_SD Startup Timing diagram

8. CML output, AC coupled internally
9. LVTTTL with internal 10kΩ pull up resistor. Asserts HIGH when input data amplitude is above threshold.
10. LVTTTL. De-asserts LOW when input data amplitude is below threshold.

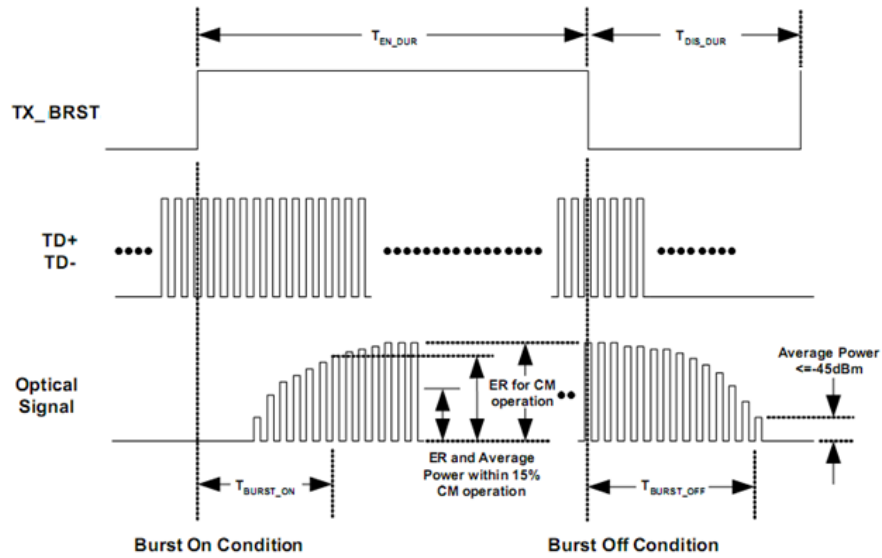

Figure 3, Timing Parameter Definition in Burst Mode Sequence

Recommended Interface Circuit

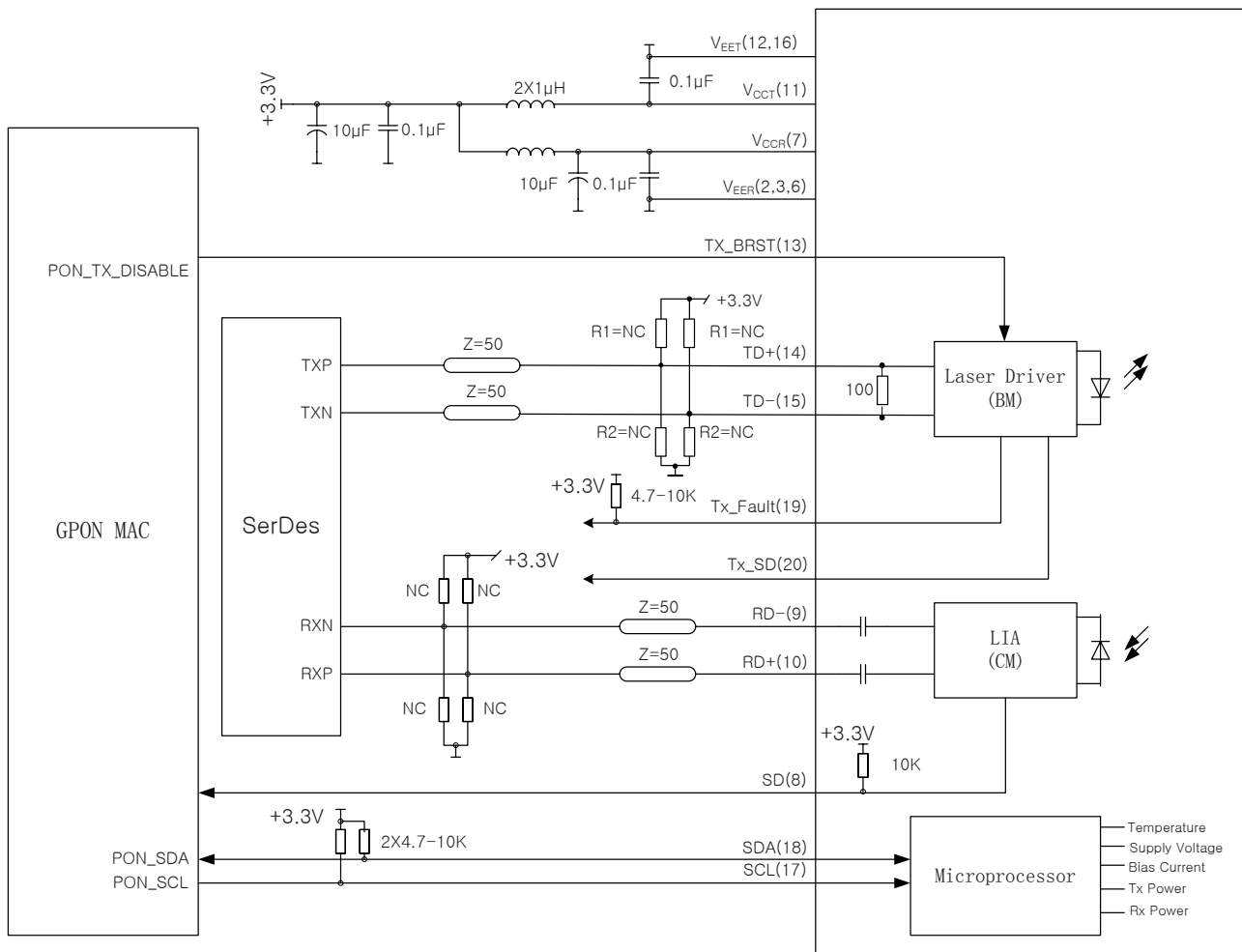

Figure 4, Recommended Interface Circuit

Pin Definitions

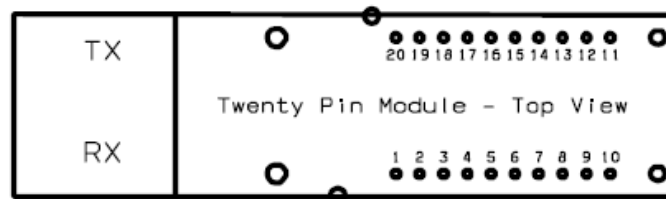

Figure 5, Pin View

Table 6 – Pin definitions

Pin	Logic	Symbol	Name/Description	Note
1	NA	NC	No User Connection	
2	NA	GND_Rx	Digital Rx ground	
3	NA	GND_Rx	Digital Rx ground	
4	NA	NC	Reserved, No User Connection	
5	NA	NC	Reserved, No User Connection	
6	NA	GND_Rx	Digital Rx Ground	
7	NA	Vcc_Rx	Digital Rx Vcc	
8	LVTTL-O	SD	Signal Detect output, pull up internally (4.7kΩ). Asserts high when input optical power level is above threshold	
9	CML-O	RxD-	RX data bar output, CML. 50Ω terminated to Vcc and AC coupled to module output	
10	CML-O	RxD+	RX data output, CML. 50Ω terminated to Vcc and AC coupled to module output	
11	NA	Vcc_Tx	Digital Tx Vcc	
12	NA	GND_Tx	Digital Tx Ground	
13	LVTTL-I	Tx_BRST	Tx Burst Enable. LVTTL Input, Active High.	
14	CML-I	TxD+	Tx data input. Internally DC coupled. 100Ω differential termination.	
15	CML-I	TxD-	Tx data bar input. Internally DC coupled. 100Ω differential termination.	
16	NA	GND_Tx	Digital Tx Ground	
17	LVTTL-I	SCL	I ² C Clock input	1
18	LVTTL-I/O	SDA	I ² C Data input/output	1
19	LVTTL-O	Tx_Fault	LVTTL transmitter fault, high active.	
20	LVTTL-O	Tx_SD	Tx Transmitter State Indication, assert High When Tx ON.	

Note

1. This pin is an open collector/drain output pin and shall be pulled up with 4.7K-10K ohms to a Host_Vcc on the host board.

Mechanical Diagram

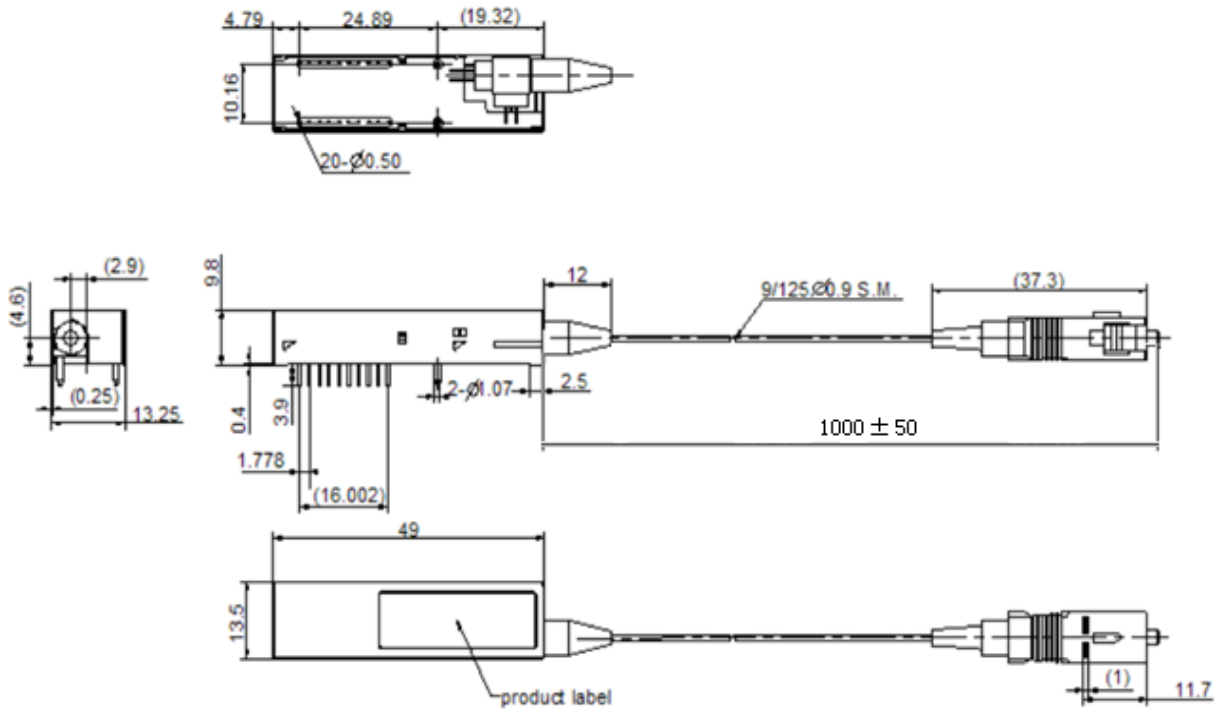

Figure 6, Mechanical Diagram

EEPROM Information

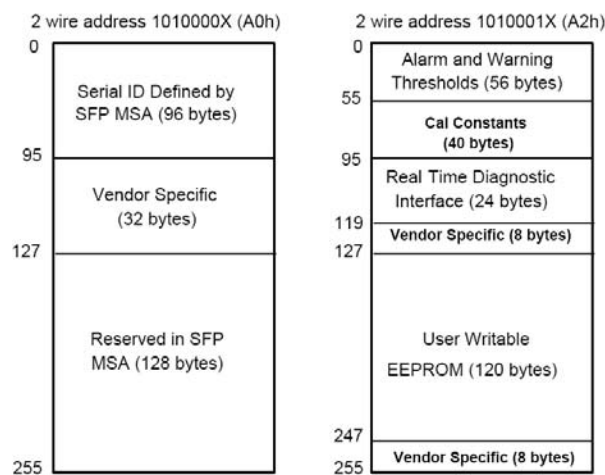

Figure 7, EEPROM Diagram

Table 7 –EEPROM Memory Content (A0h)

Addr.	Field Size (Bytes)	Name of Field	Hex	Description
0	1	Identifier	02	Module/connector soldered to motherboard
1	1	Ext. Identifier	04	MOD4
2	1	Connector	0B	Optical Pigtail

3-10	8	Transceiver	00 00 00 00 00 00 00 00	
11	1	Encoding	03	NRZ
12	1	BR, Nominal	0C	1.244Gbps
13	1	Reserved	00	
14	1	Length (9um)-km	14	20(km)
15	1	Length (9um)	C8	200(100m)
16	1	Length (50um)	00	Not Support MMF
17	1	Length (62.5um)	00	Not Support MMF
18	1	Length (Copper)	00	Not Support Copper
19	1	Reserved	00	
20-35	16	Vendor name	53 4F 55 52 43 45 50 48 4F 54 4F 4E 49 43 53 20	"SOURCEPHOTONICS "(ASCII)
36	1	Reserved	00	
37-39	3	Vendor OUI	00 00 00	
40-55	16	Vendor PN	53 46 41 33 34 32 34 54 48 50 43(54) 44 46 4A 20 20	"SFA3424THPC(T)DFJ" (ASCII)
56-59	4	Vendor Rev	xx xx 20 20	ASCII("31 30 20 20" means 1.0 Revision)
60-61	2	Wavelength	05 1E	1310nm Laser Wavelength
62	1	Reserved	00	
63	1	CC_BASE	xx	Check sum of byte 0-62
64-65	2	Options	00 0C	TX_FAULT, LOS
66	1	BR, max	00	
67	1	BR, min	00	
68-83	16	Vendor SN	xx xx xx xx xx xx xx xx xx xx xx xx xx xx xx xx	ASCII
84-91	8	Date code	xx xx xx xx xx xx 20 20	Year(2 bytes),Month(2 bytes), Day(2 bytes)
92	1	Diagnostic Monitoring Type	68	Ext Calibration, Average Power Measurement
93	1	Enhanced Options	B0	Optical Alarm/warning implemented Soft TX_DIS, TX_FAULT implemented
94	1	SFF-8472 Compliance	02	Diagnostics Compliance(SFF-8472)
95	1	CC_EXT	xx	Check sum of byte 64-94
96-255	64	Vendor Specific		

Table 8 –EEPROM Memory Content (A2h)

Addr.	Field Size (Bytes)	Name of Field	Hex	Description
0	00	Temp High Alarm	64 00(I temp)	100°C (I temp)
	2		50 00(C temp)	80°C (C temp)
2	02	Temp Low Alarm	CE 00(I temp)	-50°C (I temp)

				F3 00(C temp)	-13°C (C temp)
4	04	2	Temp High Warning	5A 00 (I temp) 4B 00(C temp)	90°C (I temp) 75°C (C temp)
6	06	2	Temp Low Warning	D8 00(I temp) F8 00(C temp)	-40°C (I temp) -8°C (C temp)
8	08	2	Voltage High Alarm	8C A0	3.6V
10	0A	2	Voltage Low Alarm	75 30	3.0V
12	0C	2	Voltage High Warning	88 B8	3.5V
14	0E	2	Voltage Low Warning	79 18	3.1V
16	10	2	Bias High Alarm	C3 50	100mA
18	12	2	Bias Low Alarm	00 00	0mA
20	14	2	Bias High Warning	9C 40	80mA
22	16	2	Bias Low Warning	00 00	0mA
24	18	2	TX Power High Alarm	9B 82	6dBm
26	1A	2	TX Power Low Alarm	22 D0	-0.5dBm
28	1C	2	TX Power High Warning	7B 86	5dBm
30	1E	2	TX Power Low Warning	2B D4	0.5dBm
32	20	2	RX Power High Alarm	07 CB	-7dBm
34	22	2	RX Power Low Alarm	00 0F	-28dBm
36	24	2	RX Power High Warning	06 30	-8dBm
38	26	2	RX Power Low Warning	00 14	-27dBm
40	28	16	Reserved	00...000	Reserved
56	38	4	RX_PWR(4) Calibration	00 00 00 00	4th order RSSI calibration coefficient
60	3C	4	RX_PWR(3) Calibration	00 00 00 00	3rd order RSSI calibration coefficient
64	40	4	RX_PWR(2) Calibration	00 00 00 00	2nd order RSSI calibration coefficient
68	44	4	RX_PWR(1) Calibration	3F 80 00 00	1st order RSSI calibration coefficient
72	48	4	RX_PWR(0) Calibration	00 00 00 00	0th order RSSI calibration coefficient
76	4C	2	TX_I(Slope) Calibration	01 00	Slope for Bias calibration
78	4E	2	TX_I(Offset) Calibration	00 00	Offset for Bias calibration
80	50	2	TX_PWR(Slope) Calibration	01 00	Slope for TX Power calibration
82	52	2	TX_PWR(Offset) Calibration	00 00	Offset for TX Power calibration
84	54	2	T(Slope) Calibration	01 00	Slope for Temperature calibration
86	56	2	T(Offset) Calibration	00 00	Offset for Temperature calibration, in units of 256ths C
88	58	2	V(Slope) Calibration	01 00	Slope for VCC calibration
90	5A	2	V(Offset) Calibration	00 00	Offset for VCC calibration
92	5C	3	Reserved	00 00 00	Reserved
95	5F	1	Checksum	xx	Checksum
96	60	2	Transceiver Temperature	xx xx	Temperature in C/256
98	62	2	Supply Voltage	xx xx	Vcc
100	64	2	TX Bias Current	xx xx	BIASMON
102	66	2	TX Optical Output Power	xx xx	Back facet monitor

104	68	2	RX Optical Input Power	xx xx	RSSI
106	6A	2	Reserved	00 00	Reserved
108	6C	2	Reserved	00 00	Reserved
110	6E.7	1bit	TX_DIS State	x	Soft TX disable state
	6E.6	1bit	Soft TX Disable	x	Write bit that allows software disable laser output.
	6E.5	1bit	Reserved.	0	Reserved
	6E.4	1bit	Rate Select State	0	NOT SUPPORTED.
	6E.3	1bit	Rate Select	0	NOT SUPPORTED.
	6E.2	1bit	TX_FAULT	x	Digital state of the TX Fault Output
	6E.1	1bit	Rx LOS	x	Digital state of the Rx LOS Output
	6E.0	1bit	Data Ready Bar	x	Indicates transceiver has achieved power up and data is ready.
111	6F.7	1bit	Reserved	0	Reserved
	6F.6	1bit	Reserved	0	Reserved
	6F.5	1bit	Reserved	0	Reserved
	6F.4	1bit	Reserved	0	Reserved
	6F.3	1bit	Reserved	0	Reserved
	6F.2	1bit	Reserved	x	Reserved
	6F.1	1bit	Reserved	0	Reserved
	6F.0	1bit	Reserved	x	Reserved
112	70.7	1bit	Temperature too high alarm	x	Temperature too high alarm
	70.6	1bit	Temperature too low alarm	x	Temperature too low alarm
	70.5	1bit	VCC too high alarm	x	VCC too high alarm
	70.4	1bit	VCC too low alarm	x	VCC too low alarm
	70.3	1bit	BIASMON too high alarm	x	BIASMON too high alarm
	70.2	1bit	BIASMON too low alarm	x	BIASMON too low alarm
	70.1	1bit	TX Power too high alarm	x	TX Power too high alarm
	70.0	1bit	TX Power too low alarm	x	TX Power too low alarm
113	71.7	1bit	RX Power too high alarm	x	RX Power too high alarm
	71.6	1bit	RX Power too low alarm	x	RX Power too low alarm
	71.5	1bit	Reserved interrupt status bit	x	Reserved interrupt status bit
	71.4	1bit	Reserved interrupt status bit	x	Reserved interrupt status bit
	71.3	1bit	Reserved interrupt status bit	x	Reserved interrupt status bit
	71.2	1bit	Reserved interrupt status bit	x	Reserved interrupt status bit
	71.1	1bit	Reserved interrupt status bit	x	Reserved interrupt status bit
	71.0	1bit	Reserved interrupt status bit	x	Reserved interrupt status bit
114	72	1	Reserved	00	Reserved
115	73	1	Reserved	00	Reserved
116	74.7	1bit	Temperature too high warning	x	Temperature too high warning
	74.6	1bit	Temperature too low warning	x	Temperature too low warning
	74.5	1bit	VCC too high warning	x	VCC too high warning

	74.4	1bit	VCC too low warning	x	VCC too low warning
	74.3	1bit	BIASMON too high warning	x	BIASMON too high warning
	74.2	1bit	BIASMON too low warning	x	BIASMON too low warning
	74.1	1bit	TX Power too high warning	x	TX Power too high warning
	74.0	1bit	TX Power too low warning	x	TX Power too low warning
117	75.7	1bit	RX Power too high warning	x	RX Power too high warning
	75.6	1bit	RX Power too low warning	x	RX Power too low warning
	75.5	1bit	Reserved interrupt status bit	0	Reserved interrupt status bit
	75.4	1bit	Reserved interrupt status bit	0	Reserved interrupt status bit
	75.3	1bit	Reserved interrupt status bit	0	Reserved interrupt status bit
	75.2	1bit	Reserved interrupt status bit	0	Reserved interrupt status bit
	75.1	1bit	Reserved interrupt status bit	0	Reserved interrupt status bit
	75.0	1bit	Reserved interrupt status bit	0	Reserved interrupt status bit
118	76	1	Reserved	00	Reserved
119	77	1	Reserved	00	Reserved
120	78	8	Vendor Specific	00 00 00 00 00 00 00 00	Vendor Specific

Table 9 – Digital Diagnostic Specification (A2h)

Data Address	Parameter	Range	Accuracy
96-97	Temperature	0 to 70°C (c-temp) -40 to -85°C (l-temp)	±5°C
98-99	Vcc Voltage	0 to Vcc	±5%
100-101	Bias Current	0 to 100mA	±10%
102-103	TX Power	0 to 5dBm	±3dB
104-105	RX Power	-28 to -8dBm	±3dB

Order Information

Table 10 – Order Information

Part No.	Application	Data Rate	Laser Source	Fiber Type	Temp Range
SFA-34-24T-HP-CDFJ	GPON ONT	TX:1244.16Mb/s RX:2488.32Mb/s	1310nm DFB	SMF	0 to 70°C
SFA-34-24T-HP-TDFJ	GPON ONT	TX:1244.16Mb/s RX:2488.32Mb/s	1310nm DFB	SMF	-40 to 85°C

Warnings

Handling Precautions: This device is susceptible to damage as a result of electrostatic discharge (ESD). A static free environment is highly recommended. Follow guidelines according to proper ESD procedures.

Laser Safety: Radiation emitted by laser devices can be dangerous to human eyes. Avoid eye exposure to direct or indirect radiation.

Legal Notice

IMPORTANT NOTICE!

All information contained in this document is subject to change without notice, at Source Photonics's sole and absolute discretion. Source Photonics warrants performance of its products to current specifications only in accordance with the company's standard one-year warranty; however, specifications designated as "preliminary" are given to describe components only, and Source Photonics expressly disclaims any and all warranties for said products, including express, implied, and statutory warranties, warranties of merchantability, fitness for a particular purpose, and non-infringement of proprietary rights. Please refer to the company's Terms and Conditions of Sale for further warranty information.

Source Photonics assumes no liability for applications assistance, customer product design, software performance, or infringement of patents, services, or intellectual property described herein. No license, either express or implied, is granted under any patent right, copyright, or intellectual property right, and Source Photonics makes no representations or warranties that the product(s) described herein are free from patent, copyright, or intellectual property rights. Products described in this document are NOT intended for use in implantation or other life support applications where malfunction may result in injury or death to persons. Source Photonics customers using or selling products for use in such applications do so at their own risk and agree to fully defend and indemnify Source Photonics for any damages resulting from such use or sale.

THE INFORMATION CONTAINED IN THIS DOCUMENT IS PROVIDED ON AN "AS IS" BASIS. Customer agrees that Source Photonics is not liable for any actual, consequential, exemplary, or other damages arising directly or indirectly from any use of the information contained in this document. Customer must contact Source Photonics to obtain the latest version of this publication to verify, before placing any order, that the information contained herein is current.

Contact

U.S.A. Headquarters

20550 Nordhoff Street
Chatsworth, CA 91311
USA

Tel: +1-818-773-9044

Fax: +1-818-773-0261

China

Building #2&5, West Export Processing Zone
No. 8 Kexin Road, Hi-Tech Zone
Chengdu, 611731, China

Tel: +86-28-8795-8788

Fax: +86-28-8795-8789

Taiwan

9F, No 81, Shui Lee Rd.
Hsinchu, Taiwan, R.O.C.

Tel: +886-3-5169222

Fax: +886-3-5169213

© Copyright Source Photonics, Inc. 2009~2012

All rights reserved