





Features

-  EFD20 SMD Platform
-  RoHS Compliant Product
-  Operating temperature: -40 °C~105 °C
-  AEC-Q200 Qualified except ESD and Vibration
-  Build in TS16949 facility

Electrical Specifications @+25 °C

Part Number	Application	Turn ratio				Primary Secondary Isolation	Primary Inductance (uH+/-10%)	Leakage Inductance (uH MAX)	DC Bias Inductance (uH MIN)	DCR (mΩ MAX)
		Pri	Sec1	Sec2	Sec3					Pri.
M1401 M1	26W Flyback Transformer Vin=80~480Vdc, Freq.=200kHz Vout1=7.5Vdc, 2.0A Vout2= 13Vdc, 0.8A Vout3=7.5Vdc, 0.1A	11	1	1.66	1	2700Vdc, 2 Seconds	140	3.5	112	300

Schematic

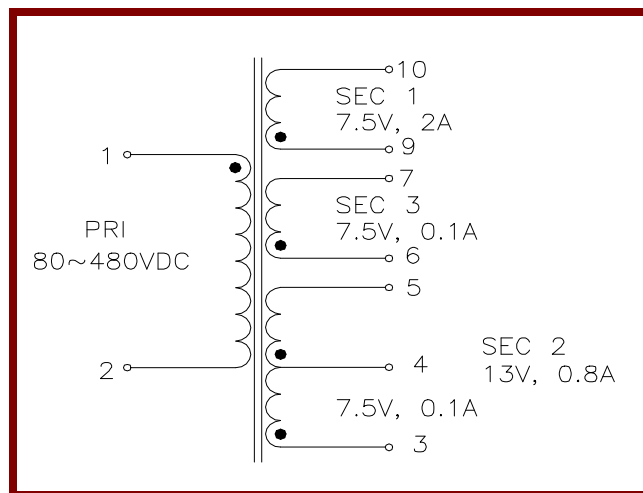

Automotive

Mechanical Outlines

Dimensions $\frac{\text{MM}}{\text{INCH}}$
 Unless otherwise specified
 All dimensions are $\pm \frac{0.13}{0.005}$

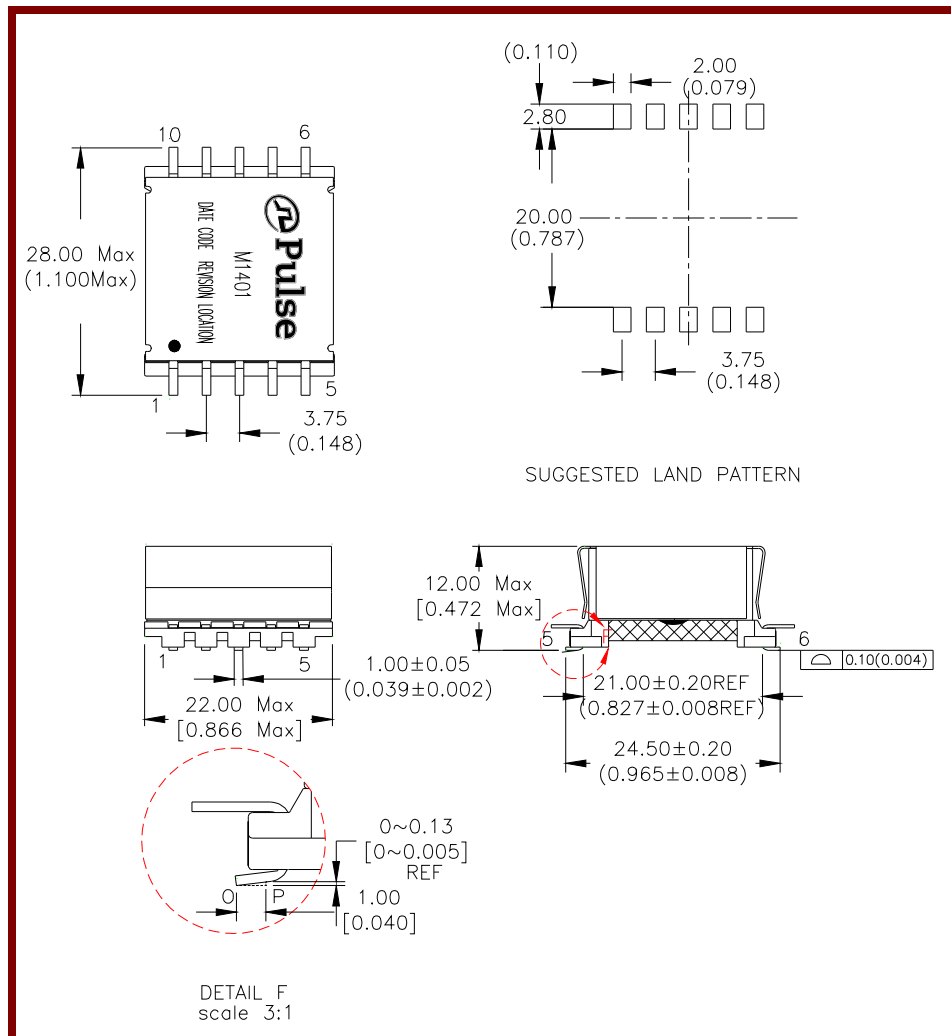

Packing Information

- Type: Tape & Reel
- Quantities per reel: 100PCs
- Reels per box: 3PCs
- Unit Weight: 12.5g