

Mutter / nut

Bolzen / bolt

Gewinde / thread
M3 / #4-40

ohne / without

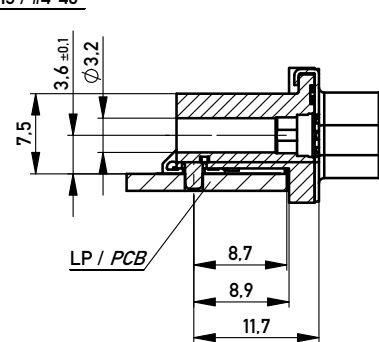
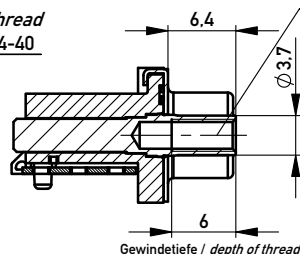
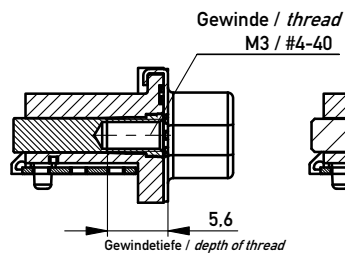

Anschlussbereich verzinkt
terminal area tin plating

Koplanarität der Anschlüsse ≤ 0.1 mm
coplanarity area of termination ≤ 0.1 mm

Anforderungsstufe: 2
class: 2

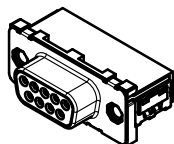

224818	174428	Ø3.2			
464553	154142			#4-40	
	154141			M3	
214647	204773		#4-40		
384960	214643		M3		
Ident-Nr. part-no. Gurt tape on reel	Ident-Nr. part-no. Tray tray	ohne without	Mutter nut	Bolzen bolt	Bemerkung remark

Verpackt in Tray
Verpackungseinheit 32 Stück
tray packaging
packaging unit 32 pcs

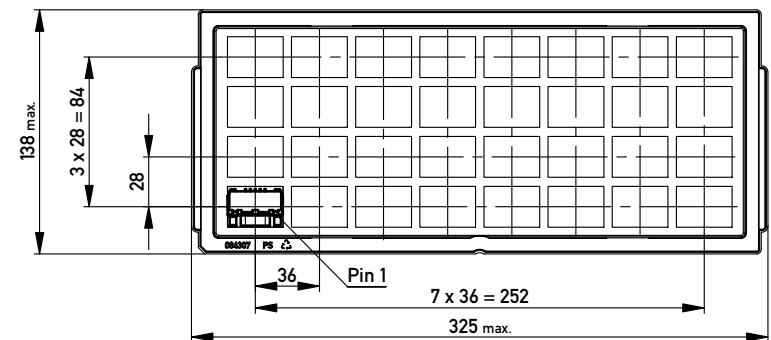

Sonstige Angaben siehe Zeichnung 204630 / additional indications according to drawing 204630

Verpackt in Gurtverpackung - Tape on Reel Packaging
Verpackungseinheit: 125 Stück - Packaging unit: 125 pcs

Abspulrichtung - Reel off Direction

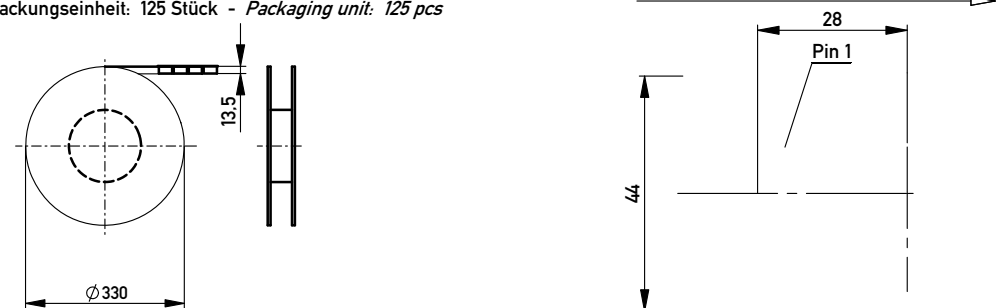

Sonstige Angaben siehe Zeichnung 204656 / additional indications according to drawing 204656

Layoutvorschlag
recommended layout

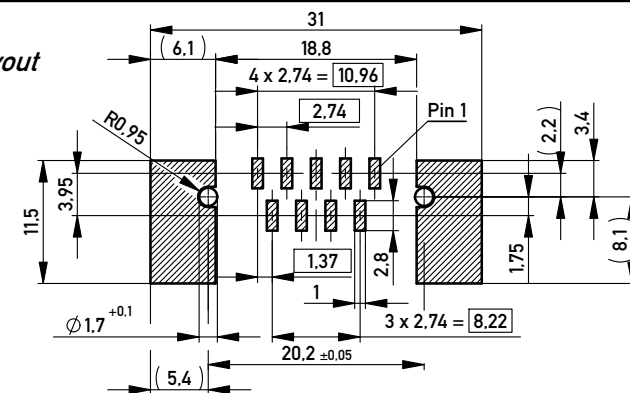

Fehlende Masse und Angaben siehe DIN 41652 / Missing information and dimensions according to DIN 41652
Sonstige Angaben siehe Fertigungsunterlagen / Additional indications according to production documentation

Information: All rights reserved. Only for Information. To ensure that this is the latest version of this drawing, please contact one of the ERNI companies before using.	Tolerances	 All Dimensions in mm	Scale 2:1
	Subject to modification without prior notice. Drawing will not be updated.		
www.ERNI.com	Designation		TMC-S-09-SMD-Euro-BA8 TMC-S-09-SMD-Euro-BA8
	144847		
n Index	16.02.2012 Date	Class	TMCS