

Mutter / nut

Bolzen / bolt

Gewinde / thread
M3 / #4-40

ohne / without

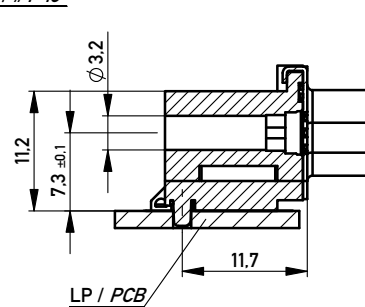
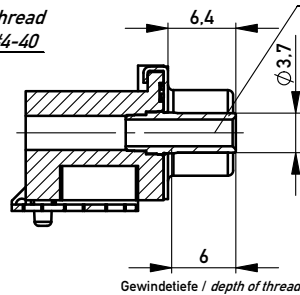
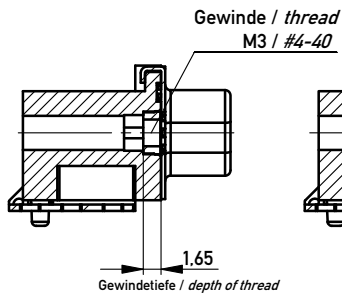

Anschlussbereich verzinkt
terminal area tin plating

Koplanarität der Anschlüsse ≤ 0.1 mm
coplanarity area of termination ≤ 0.1 mm

Anforderungsstufe: 2
class: 2

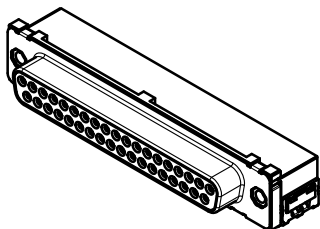

	174443	Ø3.2			
	154250			#4-40	
	154249			M3	
	154248		#4-40		
	154247		M3		
Ident-Nr. part-no. Gurt tape on reel	Ident-Nr. part-no. Tray tray	ohne without	Mutter nut	Bolzen bolt	Bemerkung remark

Verpackt in Tray
Verpackungseinheit 16 Stück
tray packaging
packaging unit 16 pcs

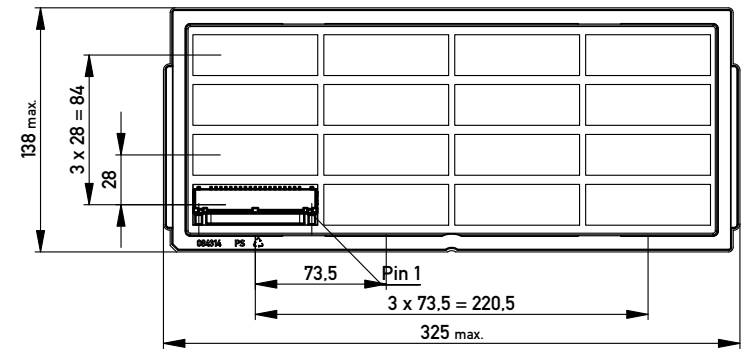

Sonstige Angaben siehe Zeichnung 204629 / additional indications according to drawing 204629

Verpackt in Gurtverpackung - Tape on Reel Packaging
Verpackungseinheit: 75 Stück - Packaging unit: 75 pcs

Abspulrichtung - Reel off Direction

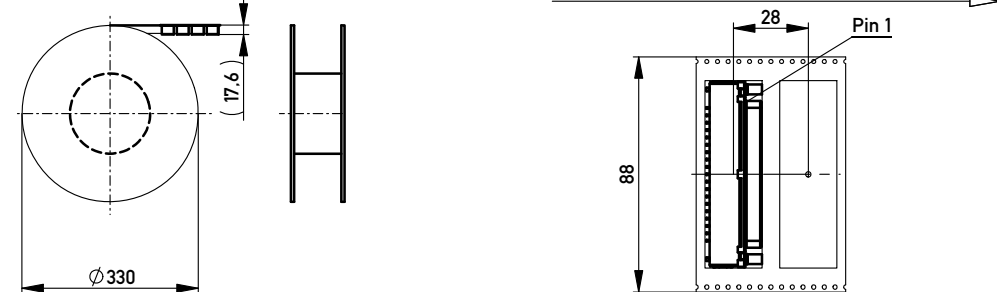

Sonstige Angaben siehe Zeichnung 204655 / additional indication according to drawing 204655

Layoutvorschlag
recommended
layout

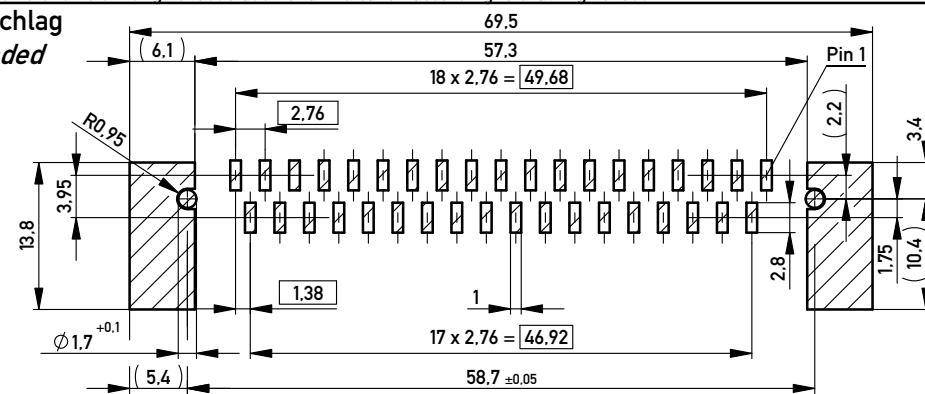

Fehlende Masse und Angaben siehe DIN 41652 / Missing information and dimensions according to DIN 41652
Sonstige Angaben siehe Fertigungsunterlagen / Additional indications according to production documentation

Information: All rights reserved. Only for Information. To ensure that this is the latest version of this drawing, please contact one of the ERNI companies before using.	Tolerances	Scale 2:1	Designation TMC-S-37-SMD-Standard-BA8 <i>TMC-S-37-SMD-Standard-BA8</i>
	 All Dimensions in mm		
Copyright by ERNI GmbH Proprietary notice pursuant to ISO 9006 to be observed.	Index	Date 08.12.2011	Class TMCS