

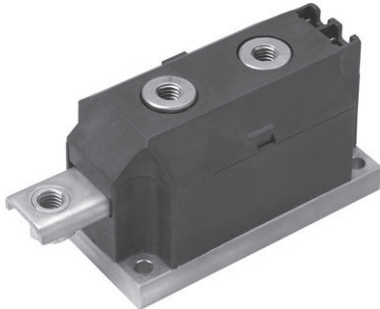



Fast Recovery Diodes, 250 A (MAGN-A-PAK Power Modules)



MAGN-A-PAK

FEATURES

- Fast recovery time characteristics
- Electrically isolated base plate
- Industrial standard package
- Simplified mechanical designs, rapid assembly
- High surge capability
- Large creepage distances
- 3000 V_{RMS} isolating voltage
- UL approved file E78996 
- Compliant to RoHS Directive 2002/95/EC
- Designed and qualified for industrial level



RoHS
COMPLIANT

PRODUCT SUMMARY

I _{F(AV)}	250 A
Type	Modules - Diode, Fast

DESCRIPTION

The VSK.L240 Series of MAGN-A-PAKs uses fast recovery power diodes in four basic configurations. The semiconductors are electrically isolated from the metal base, allowing common heatsinks and compact assemblies to be built. Application includes power supplies, battery chargers, welders, motor controls and general industrial current rectification. These modules are intended for those applications where fast recovery characteristics are required.

MAJOR RATINGS AND CHARACTERISTICS

SYMBOL	CHARACTERISTICS	VSK.L240		UNITS
		S10/S20	S30	
I _{F(AV)}		250	240	A
	T _C	100	100	°C
I _{F(RMS)}		392	377	A
I _{FSM}	50 Hz	8000	7500	
	60 Hz	8400	7850	
I ² t	50 Hz	322	280	kA ² s
	60 Hz	294	256	
I ² √t		3220	2800	kA ² √s
V _{RRM}	Range	600 to 2500		V
T _J	Range	- 40 to 150		°C



ELECTRICAL SPECIFICATIONS

VOLTAGE RATINGS					
TYPE NUMBER	VOLTAGE CODE	t _{rr} CODE	V _{RRM} , MAXIMUM REPETITIVE PEAK REVERSE VOLTAGE V	V _{RSM} , MAXIMUM NON-REPETITIVE PEAK REVERSE VOLTAGE V	I _{RRM} MAXIMUM AT 150 °C mA
VSK.L240	06	S10	600	700	50
	10	S10	1000	1100	
	12	S20	1200	1300	
	14	S20	1400	1500	
	20	S30	2000	2100	
	25	S30	2500	2600	

FORWARD CONDUCTION							
PARAMETER	SYMBOL	TEST CONDITIONS			VSK.L240		UNITS
					S10/S20	S30	
Maximum average forward current at case temperature	I _{F(AV)}	180° conduction, half sine wave			250	240	A
					100	100	°C
Maximum RMS forward current	I _{F(RMS)}	As AC switch			392	377	
Maximum peak, one-cycle forward non-repetitive, surge current	I _{FSM}	Sinusoidal half wave, initial T _J = T _J maximum	t = 10 ms	No voltage reappplied	8000	7500	A
			t = 8.3 ms		8400	7850	
			t = 10 ms	100 % V _{RRM} reappplied	6750	6300	
			t = 8.3 ms		7100	6600	
Maximum I ² t for fusing	I ² t		t = 10 ms	No voltage reappplied	322	280	kA ² s
			t = 8.3 ms		294	256	
			t = 10 ms	100 % V _{RRM} reappplied	228	198	
			t = 8.3 ms		208	181	
Maximum I ² √t for fusing	I ² √t	t = 0.1 ms to 10 ms, no voltage reappplied			3220	2800	kA ² √s
Low level value of threshold voltage	V _{F(TO)1}	(16.7 % × π × I _{F(AV)} < I < π × I _{F(AV)}), T _J = T _J maximum			0.98	0.98	V
High level value of threshold voltage	V _{F(TO)2}	(I > π × I _{F(AV)}), T _J = T _J maximum			1.31	1.31	
Low level value of forward slope resistance	r _{f1}	(16.7 % × π × I _{F(AV)} < I < π × I _{F(AV)}), T _J = T _J maximum			0.75	0.97	mΩ
High level value of forward slope resistance	r _{f2}	(I > π × I _{F(AV)}), T _J = T _J maximum			0.41	0.60	
Maximum forward voltage drop	V _{FM}	I _{FM} = 800 A, T _J = 150 °C, t _p = 10 ms Average power = V _{F(TO)} × I _{F(AV)} + r _f × (I _{F(RMS)}) ²			1.57	1.75	V



RECOVERY CHARACTERISTICS							
CODE	MAXIMUM VALUE AT $T_J = 25\text{ }^\circ\text{C}$	TEST CONDITIONS			TYPICAL VALUES AT $T_J = 150\text{ }^\circ\text{C}$		
	t_{rr} AT 25 % I_{RRM} (μs)	I_{pk} SQUARE PULSE (A)	di/dt (A/ μs)	V_r (V)	t_{rr} AT 25 % I_{RRM} (μs)	Q_{rr} (μC)	I_r (A)
S10	1.0	500	100	- 50	2.7	135	100
S20	2.0				3.5	250	145
S30	3.0				3.6	360	200

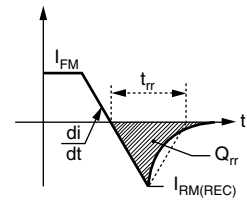

BLOCKING				
PARAMETER	SYMBOL	TEST CONDITIONS	VALUES	UNITS
Maximum peak reverse leakage current	I_{RRM}	$T_J = 150\text{ }^\circ\text{C}$, leakage current	50	mA
RMS insulation voltage	V_{INS}	50 Hz, circuit to base, all terminals shorted, $25\text{ }^\circ\text{C}$, $t = 1\text{ s}$	3000	V

THERMAL AND MECHANICAL SPECIFICATIONS				
PARAMETER	SYMBOL	TEST CONDITIONS	VALUES	UNITS
Maximum junction operating and storage temperature range	T_J, T_{Stg}		- 40 to 150	$^\circ\text{C}$
Maximum internal thermal resistance, junction to case per junction	R_{thJC}	DC operation	0.125	K/W
Thermal resistance, case to heatsink per module	R_{thCS}	Mounting surface flat, smooth and greased	0.02	
Mounting torque $\pm 10\%$	MAP to heatsink	A mounting compound is recommended and the torque should be rechecked after a period of about 3 hours to allow for the spread of the compound.	4 to 6	Nm
	busbar to MAP		8 to 10	
Approximate weight			850	g
			30	oz.
Case style			MAGN-A-PAK	

ΔR CONDUCTION PER JUNCTION				
CONDUCTION ANGLE	SINUSOIDAL CONDUCTION	RECTANGULAR CONDUCTION	TEST CONDITIONS	UNITS
180 $^\circ$	0.008	0.007	$T_J = T_J$ maximum	K/W
120 $^\circ$	0.010	0.011		
90 $^\circ$	0.013	0.015		
60 $^\circ$	0.019	0.020		
30 $^\circ$	0.032	0.033		

Note

- The table above shows the increment of thermal resistance R_{thJC} when devices operate at different conduction angles than DC

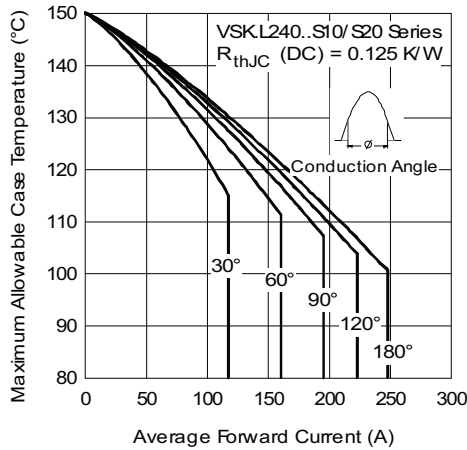

Fig. 1 - Current Ratings Characteristics

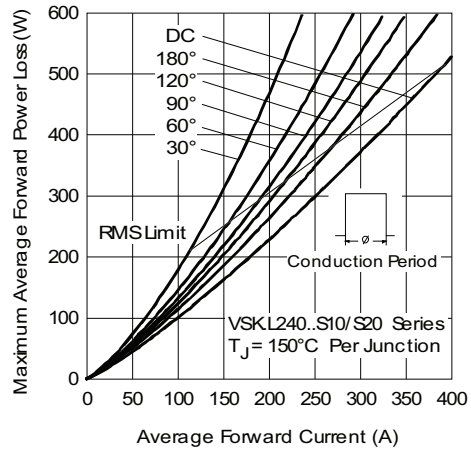

Fig. 4 - Forward Power Loss Characteristics

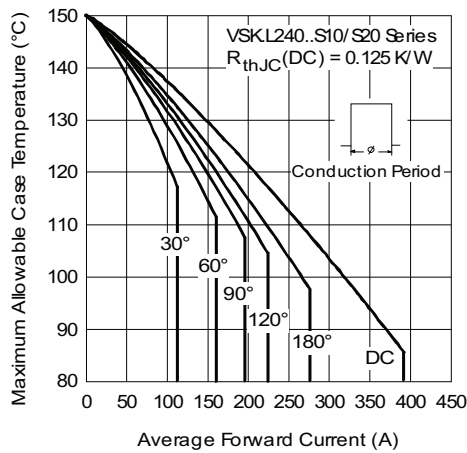

Fig. 2 - Current Ratings Characteristics

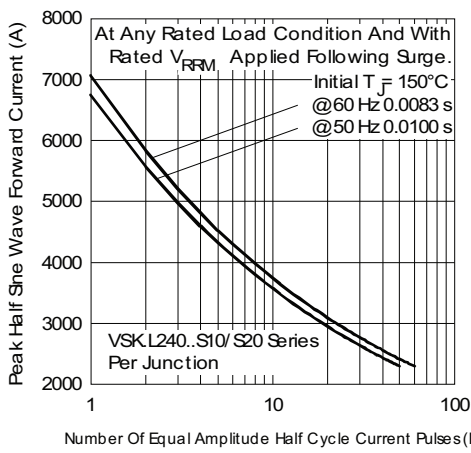

Fig. 5 - Maximum Non-Repetitive Surge Current

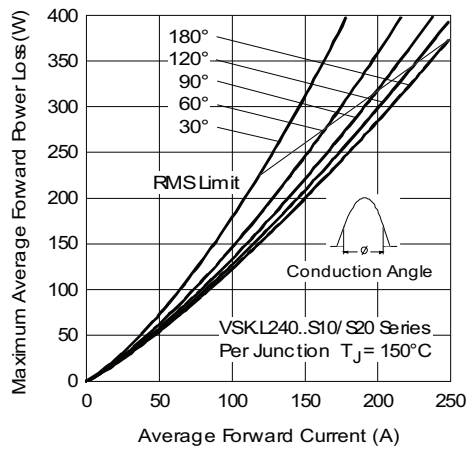

Fig. 3 - Forward Power Loss Characteristics

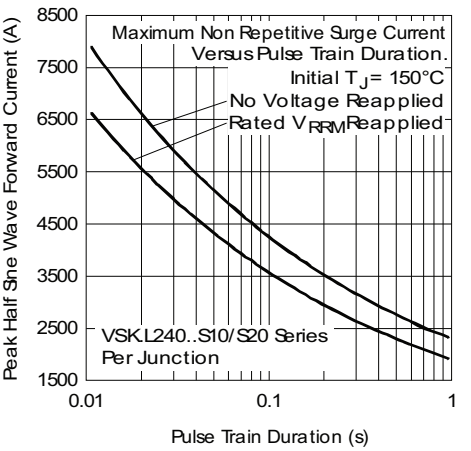

Fig. 6 - Maximum Non-Repetitive Surge Current

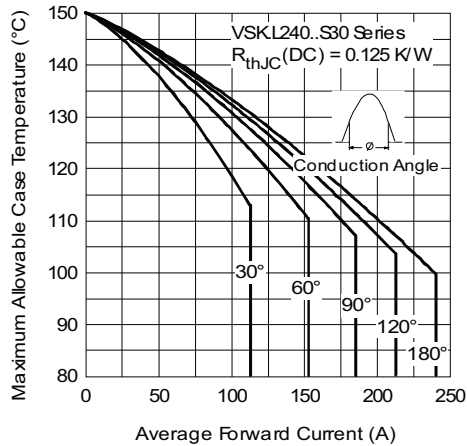

Fig. 7 - Current Ratings Characteristics

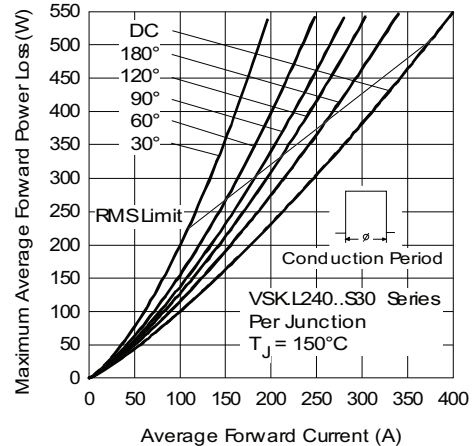

Fig. 10 - Forward Power Loss Characteristics

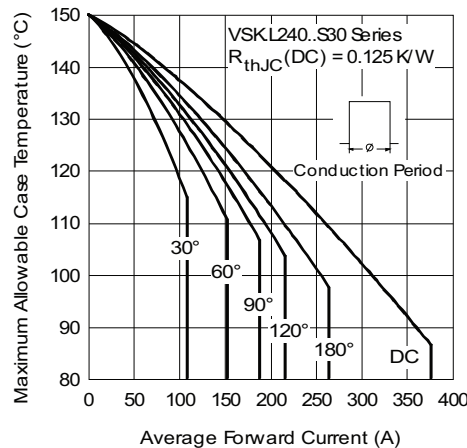

Fig. 8 - Current Ratings Characteristics

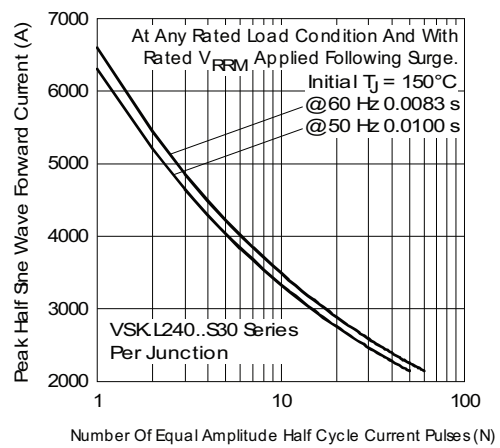

Fig. 11 - Maximum Non-Repetitive Surge Current

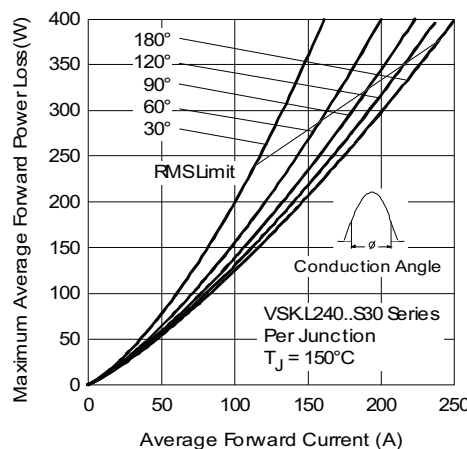

Fig. 9 - Forward Power Loss Characteristics

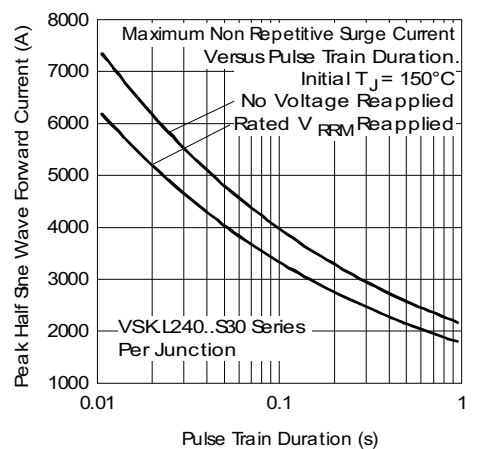

Fig. 12 - Maximum Non-Repetitive Surge Current

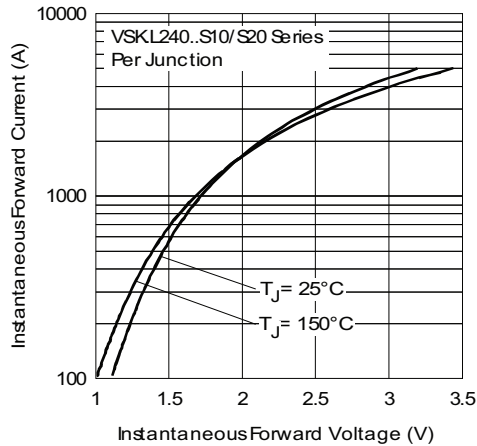

Fig. 13 - Forward Voltage Drop Characteristics

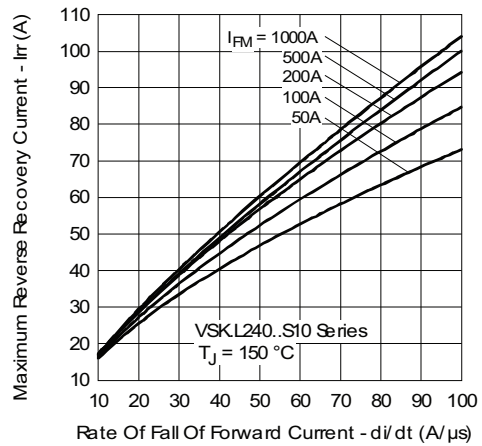

Fig. 16 - Reverse Recovery Current Characteristics

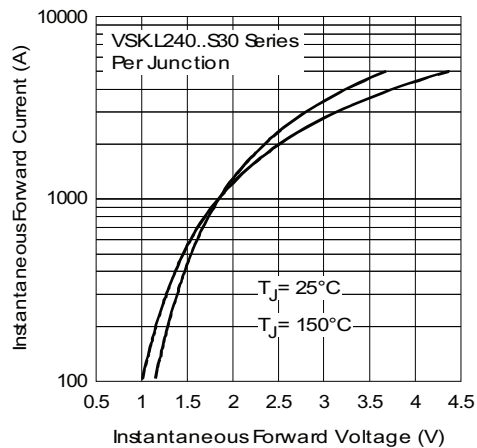

Fig. 14 - Forward Voltage Drop Characteristics

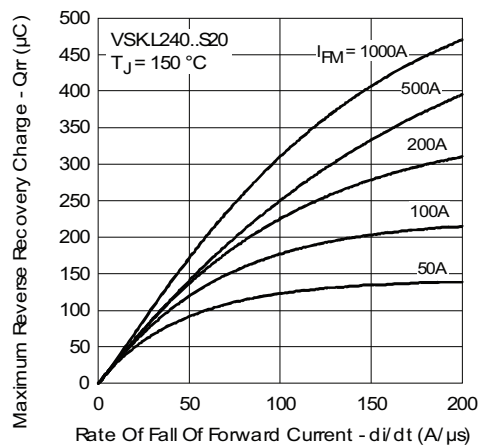

Fig. 17 - Reverse Recovery Charge Characteristics

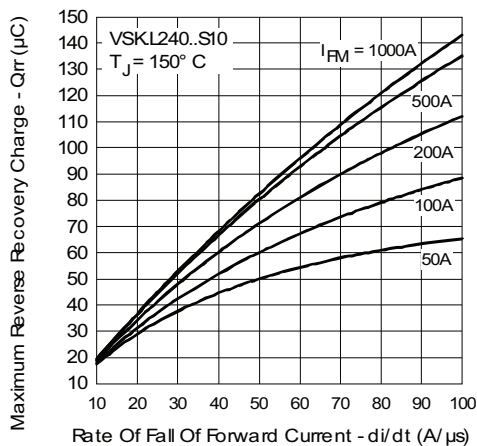

Fig. 15 - Reverse Recovery Charge Characteristics

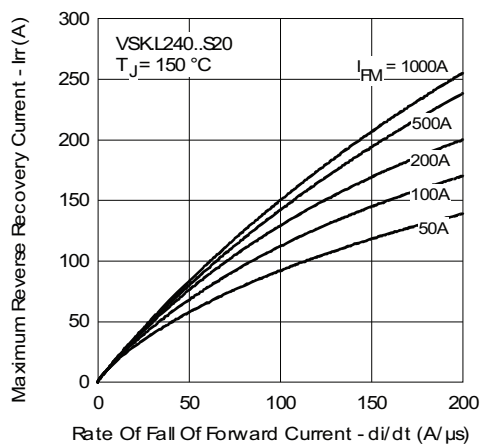

Fig. 18 - Reverse Recovery Current Characteristics



VSKDL240, VSKCL240, VSKJL240, VSKEL240 Series

www.vishay.com

Vishay Semiconductors

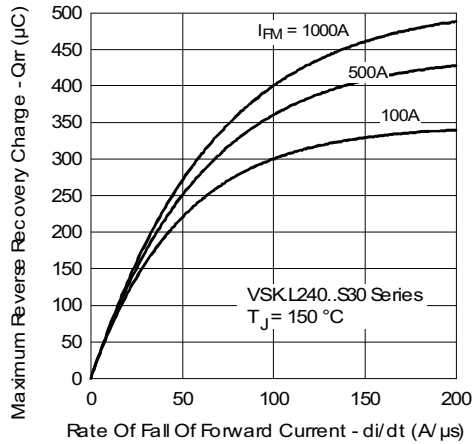

Fig. 19 - Reverse Recovery Charge Characteristics

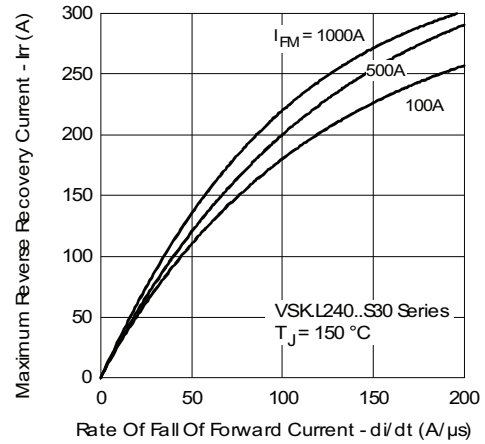

Fig. 20 - Reverse Recovery Current Characteristics

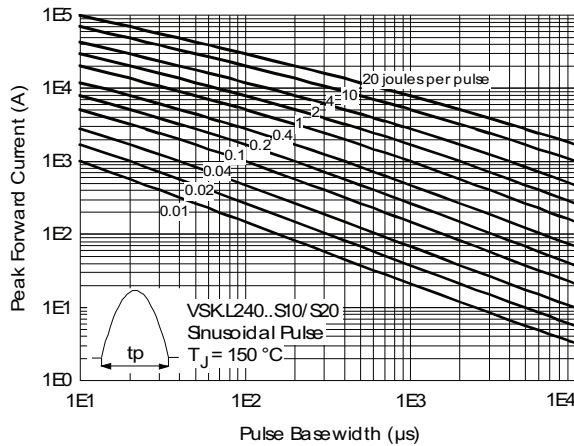

Fig. 21 - Maximum Forward Energy Power Loss Characteristics

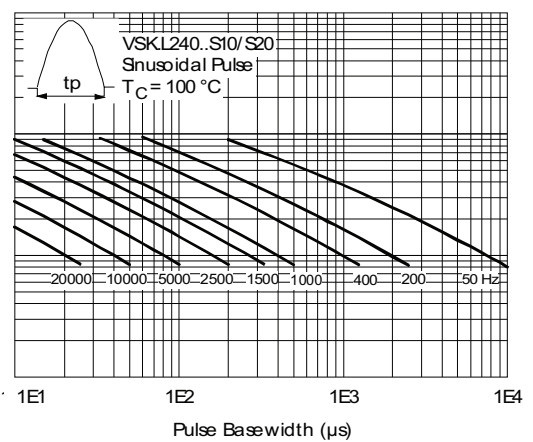
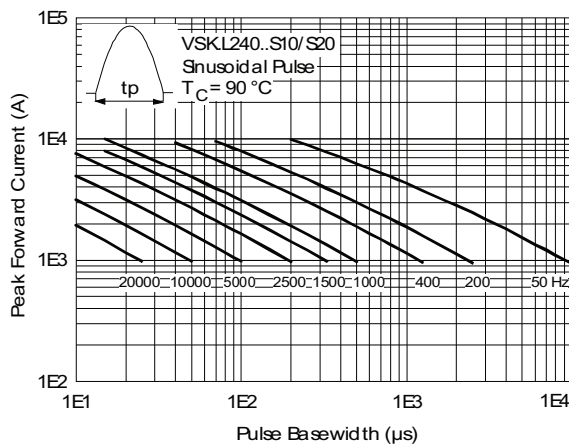
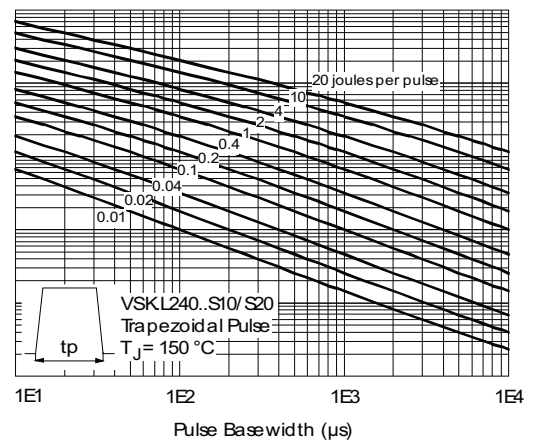

Fig. 22 - Frequency Characteristics

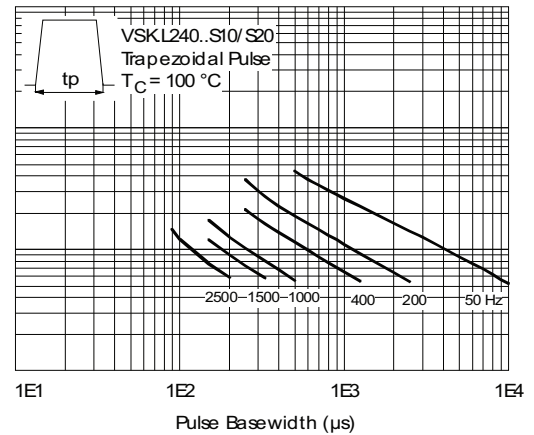
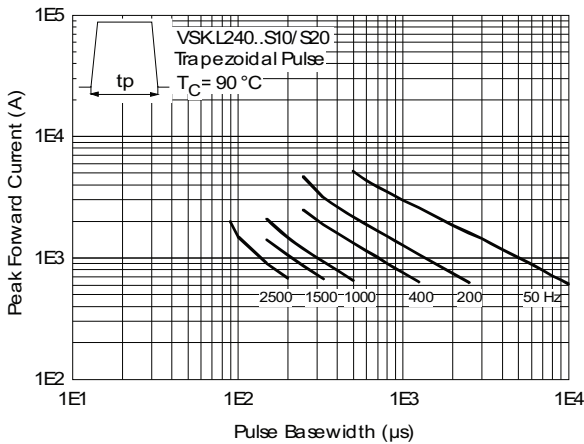

Fig. 23 - Frequency Characteristics

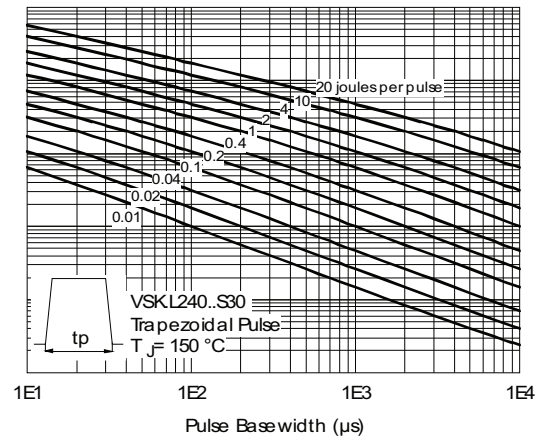
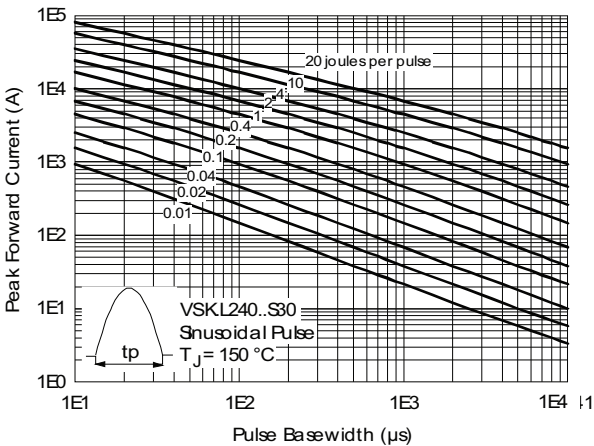

Fig. 24 - Maximum Forward Energy Power Loss Characteristics

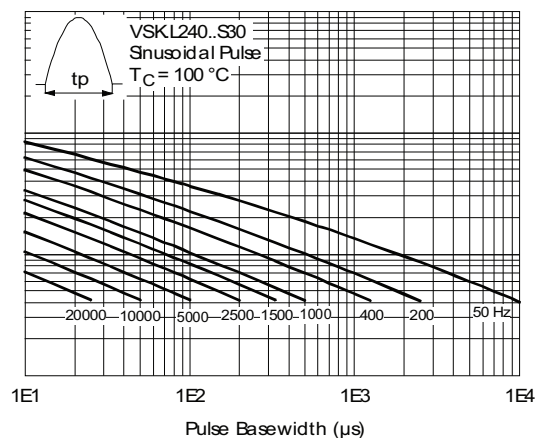
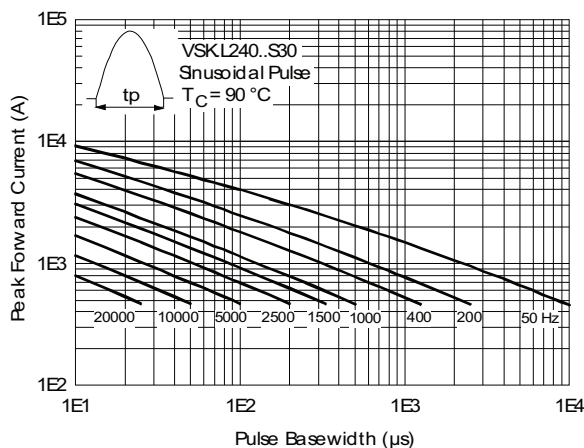

Fig. 25 - Frequency Characteristics

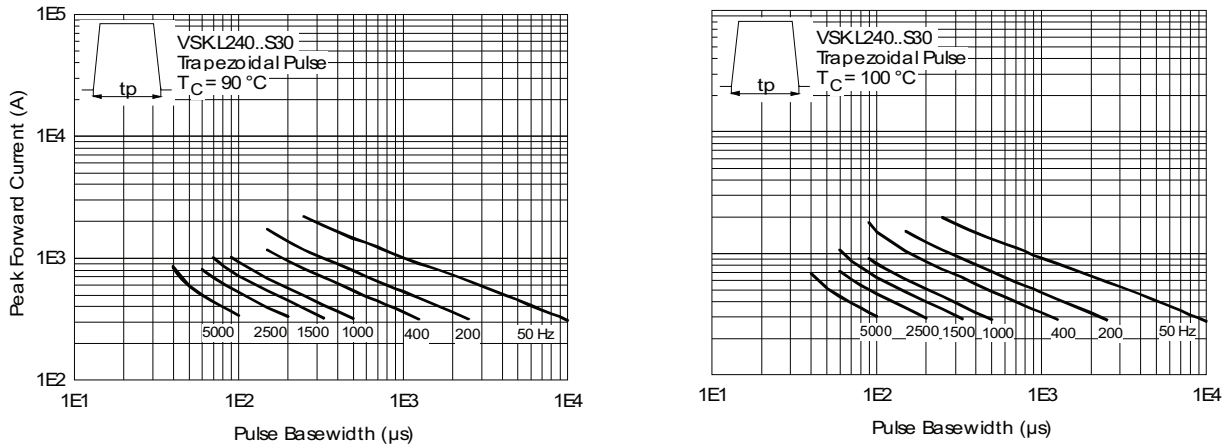

Fig. 26 - Frequency Characteristics

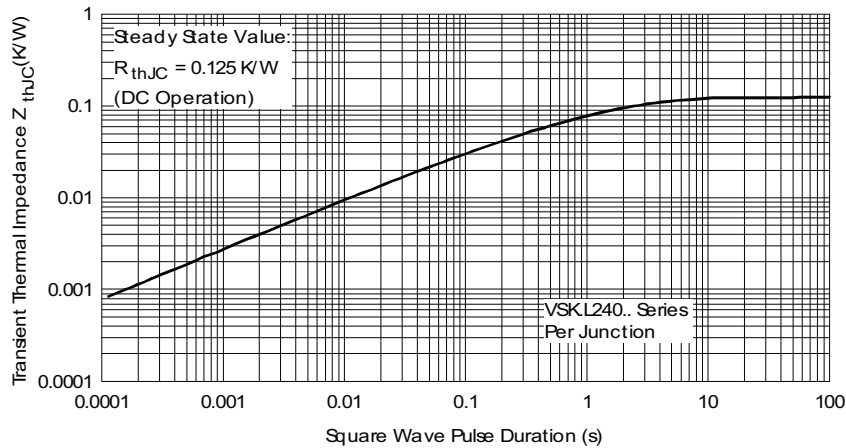

Fig. 27 - Thermal Impedance Z_{thJC} Characteristics

ORDERING INFORMATION TABLE

Device code	VSK	D	L	240	-	25	S30
	①	②	③	④		⑤	⑥

- ① - Module type
- ② - Circuit configuration (see Circuit Configuration table)
- ③ - L = Fast recovery diode
- ④ - Current rating
- ⑤ - Voltage code x 100 = V_{RRM} (see Voltage Ratings table)
- ⑥ - t_{rr} code (see Recovery Characteristics table)

S10 = 1000 ns
S20 = 2000 ns
S30 = 3000 ns



CIRCUIT CONFIGURATION		
CIRCUIT	CIRCUIT CONFIGURATION CODE	CIRCUIT DRAWING
Two diodes doubler circuit	D	<p>VSKD...</p>
Two diodes common cathodes	C	<p>VSKC...</p>
Two diodes common anodes	J	<p>VSKJ...</p>
Single diode	E	<p>VSKE...</p>

LINKS TO RELATED DOCUMENTS	
Dimensions	www.vishay.com/doc?95086

MAGN-A-PAK

DIMENSIONS in millimeters (inches)

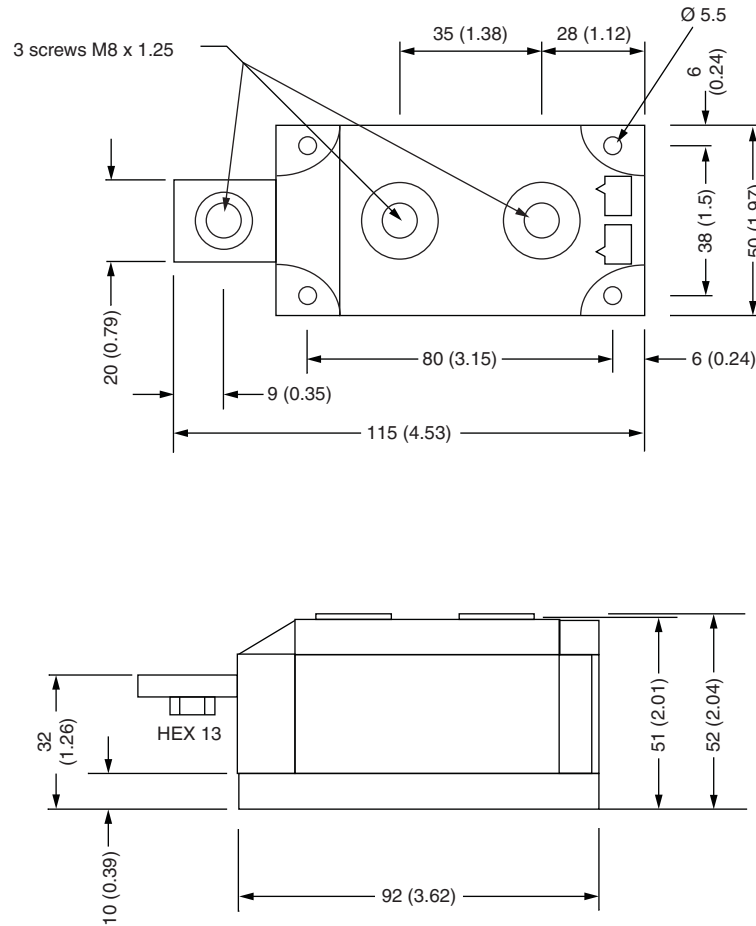

Notes

- Dimensions are nominal
- Full engineering drawings are available on request
- UL identification number for gate and cathode wire: UL 1385
- UL identification number for package: UL 94 V-0



Disclaimer

ALL PRODUCT, PRODUCT SPECIFICATIONS AND DATA ARE SUBJECT TO CHANGE WITHOUT NOTICE TO IMPROVE RELIABILITY, FUNCTION OR DESIGN OR OTHERWISE.

Vishay Intertechnology, Inc., its affiliates, agents, and employees, and all persons acting on its or their behalf (collectively, "Vishay"), disclaim any and all liability for any errors, inaccuracies or incompleteness contained in any datasheet or in any other disclosure relating to any product.

Vishay makes no warranty, representation or guarantee regarding the suitability of the products for any particular purpose or the continuing production of any product. To the maximum extent permitted by applicable law, Vishay disclaims (i) any and all liability arising out of the application or use of any product, (ii) any and all liability, including without limitation special, consequential or incidental damages, and (iii) any and all implied warranties, including warranties of fitness for particular purpose, non-infringement and merchantability.

Statements regarding the suitability of products for certain types of applications are based on Vishay's knowledge of typical requirements that are often placed on Vishay products in generic applications. Such statements are not binding statements about the suitability of products for a particular application. It is the customer's responsibility to validate that a particular product with the properties described in the product specification is suitable for use in a particular application. Parameters provided in datasheets and/or specifications may vary in different applications and performance may vary over time. All operating parameters, including typical parameters, must be validated for each customer application by the customer's technical experts. Product specifications do not expand or otherwise modify Vishay's terms and conditions of purchase, including but not limited to the warranty expressed therein.

Except as expressly indicated in writing, Vishay products are not designed for use in medical, life-saving, or life-sustaining applications or for any other application in which the failure of the Vishay product could result in personal injury or death. Customers using or selling Vishay products not expressly indicated for use in such applications do so at their own risk and agree to fully indemnify and hold Vishay and its distributors harmless from and against any and all claims, liabilities, expenses and damages arising or resulting in connection with such use or sale, including attorneys fees, even if such claim alleges that Vishay or its distributor was negligent regarding the design or manufacture of the part. Please contact authorized Vishay personnel to obtain written terms and conditions regarding products designed for such applications.

No license, express or implied, by estoppel or otherwise, to any intellectual property rights is granted by this document or by any conduct of Vishay. Product names and markings noted herein may be trademarks of their respective owners.

Material Category Policy

Vishay Intertechnology, Inc. hereby certifies that all its products that are identified as RoHS-Compliant fulfill the definitions and restrictions defined under Directive 2011/65/EU of The European Parliament and of the Council of June 8, 2011 on the restriction of the use of certain hazardous substances in electrical and electronic equipment (EEE) - recast, unless otherwise specified as non-compliant.

Please note that some Vishay documentation may still make reference to RoHS Directive 2002/95/EC. We confirm that all the products identified as being compliant to Directive 2002/95/EC conform to Directive 2011/65/EU.