

NOTES:

1. CONNECTOR MATERIAL:
HOUSING:THERMOPLASTIC UL94 V-0
INSERTER:PBT BLACK UL94 V-0
SHIELD:Brass
SHIELD PLATING:NICKEL
CONTACT:COOPER ALLOY
CONTACT PLATING: SELECTIVE GOLD, 30 MICRO-INCHS MIN
IN CONTACT AREA
2. PIN NOT ELECTRICALLY CONNECTED MAYBE OMITTED SEE
ELECTRICAL DRAWING FOR OMITTED PINS
3. RJ45 CAVITIES CONFORM TO FCC RULES AND REGULATION
PART 68.
4. THE PART IS RECOMMENDED FOR WAVE SOLDERING
PROCESS PEAK SOLDERING TEMPERATURE IS
260°C MAX, 10 SECS MAX
5. OPERATING TEMPERATURE T=-40°C TO +85°C.
6. STORAGE TEMPERATURE T=-40°C TO +85°C.
7. ALL CRITICAL DIMENSIONS WITH "M"
8. PACKAGING INFORMATION: 50 PCS/TRAY, 1200 PCS/BOX

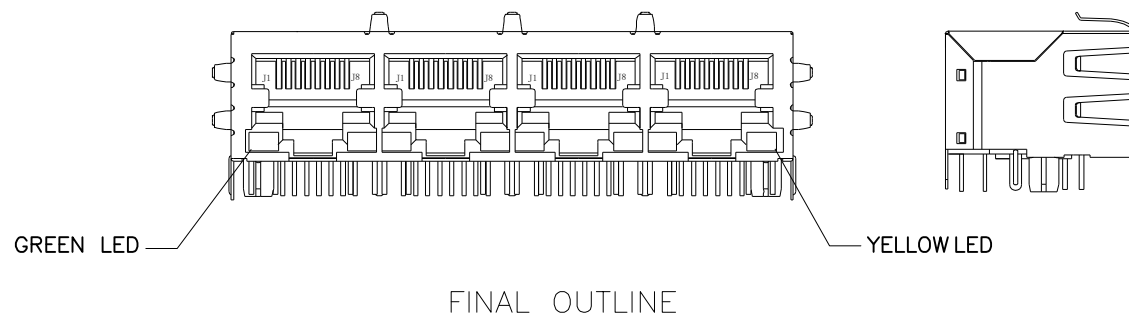
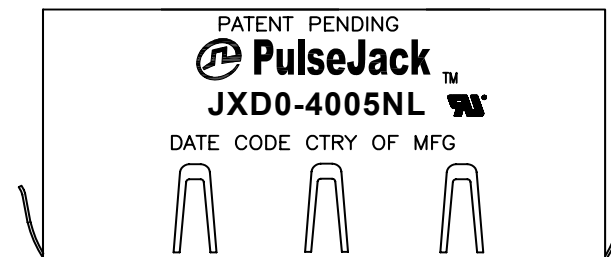

© Copyright, 2015. Pulse Electronics Corp. All rights reserved. Pulse confidential & proprietary. (06/07/16)

PRODUCT DESCRIPTION	TLA DRAWING	PS DRAWING	SHEET	PART NO.	DATASHEET REV.
CONN,RJ45,1X4,100D,1:1,TY	JXD0-4005NL - X1	-	1 OF 3	JXD0-4005NL	P1

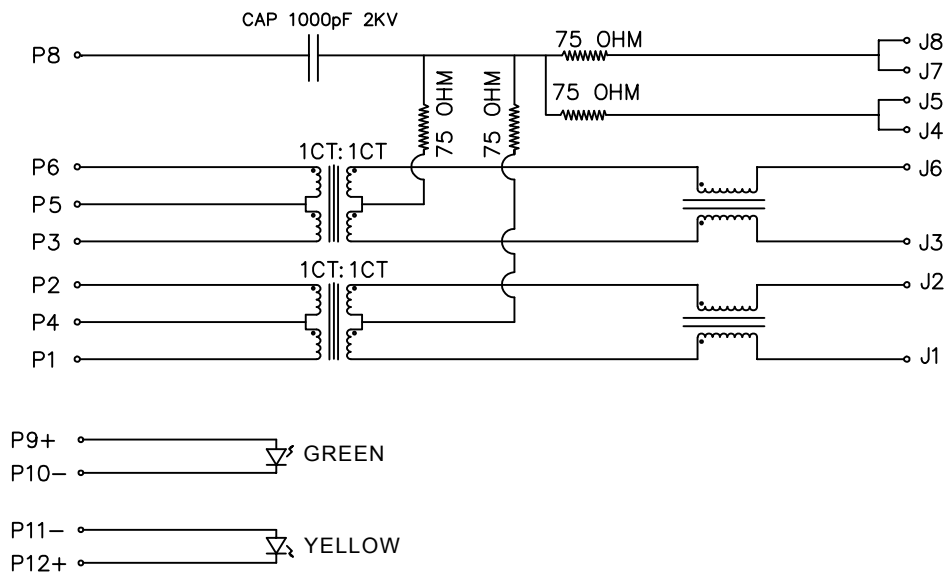

SCHEMATIC

Electronical Specifications:

- 1.0 Turn Ratio @100KHz: (P1~P2):(J1~J2) = 1:1±5%
(P7~P8):(J3~J6) = 1:1±5%
- 2.0 Primary Inductance: 350uH MIN @100KHZ,0.1V 8mA DC BIAS
- 3.0 DC Resistance:(J1~J2):(J3~J6) 1.2 OHMS MAX
- 4.0 Insertion Loss: 1-100MHz -1.2dB MAX
- 5.0 Return Loss: 1-30MHz -16dB MIN
30-60MHz -12dB MIN
60-80MHz -10dB MIN
- 6.0 CROSS TALK: 1-100MHz -30dB MIN
- 7.0 COMMON TO COMMON MODE ATTENUATION: 1-100MHz -30dB MIN
- 8.0 Isolation: PHY Side to Line Side: 1500VAC or 2250VDC

LED SPECIFICATION:

STANDARD LED	WAVELENGTH	Forward V(max)	TYP
GREEN	565nm	2.4V	2.2V
YELLOW	590nm	2.5V	2.1V

*WITH A FORWARD CURRENT OF 20mA

PRODUCT DESCRIPTION	TLA DRAWING	PS DRAWING	SHEET	PART NO.	DATASHEET REV.
CONN,RJ45,1X4,100D,1:1,TY	JXD0-4005NL - X1	-	2 OF 3	JXD0-4005NL	P1

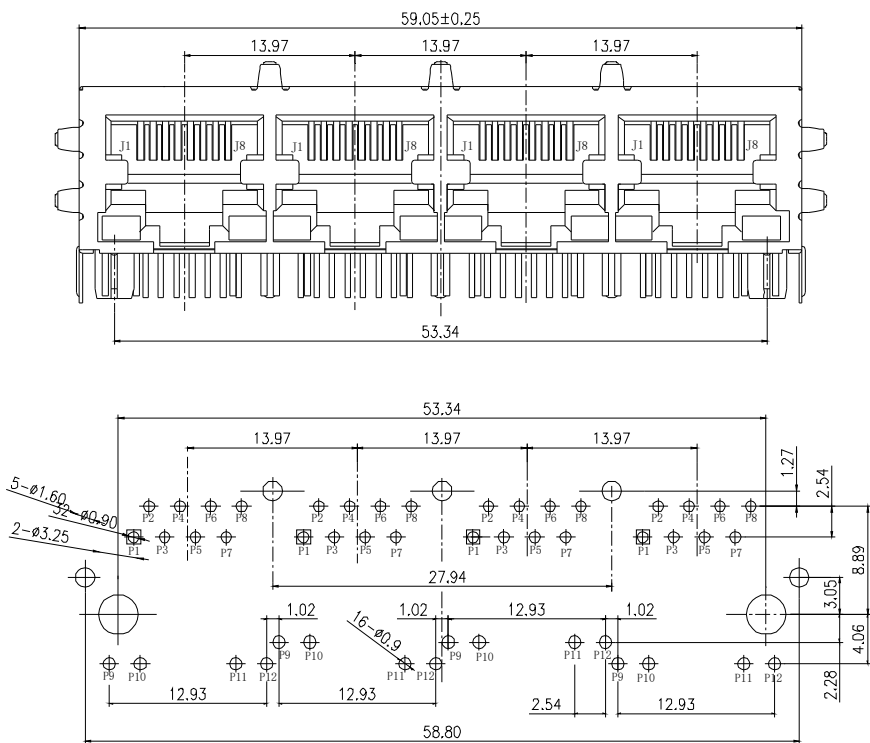

P.C.B RECOMMENDED HOLE LAYOUT SEEN FROM COMPONENT SIDE.

ALL CENTERLINE DIMENSIONS ARE BASIC

DIMENSIONS ARE IN MILLIMETERS [INCHES] WITH THE FOLLOWING TOLERANCES: [INCHES] ARE FOR REFERENCE ONLY.
X.XX= ±0.25 [±.010]

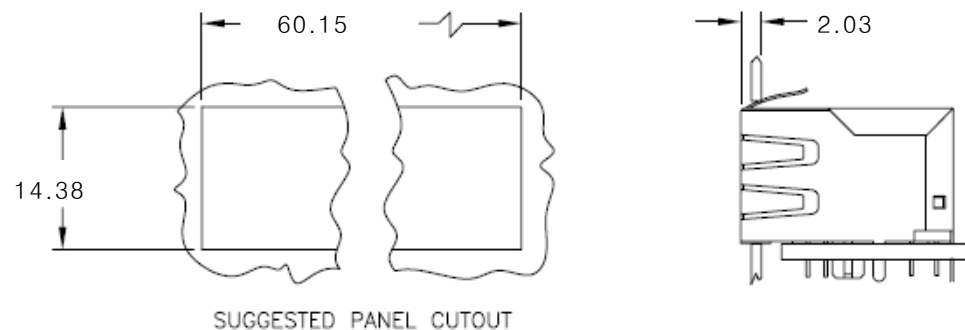
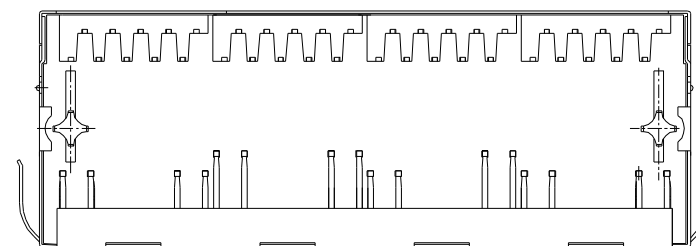
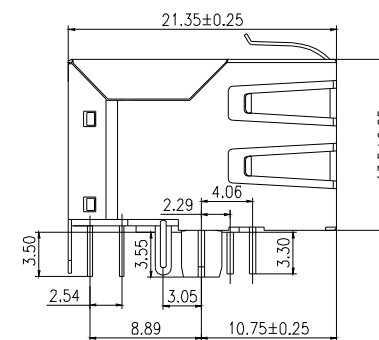

© Copyright, 2015. Pulse Electronics Corp. All rights reserved. Pulse confidential & proprietary. (06/07/16)

PRODUCT DESCRIPTION	TLA DRAWING	PS DRAWING	SHEET	PART NO.	DATASHEET REV.
CONN,RJ45,1X4,100D,1:1,TY	JXD0-4005NL - X1	-	3 OF 3	JXD0-4005NL	P1