

**REPLACEMENT TYPE : KTC4379**
**FEATURES**

- Low Saturation Voltage
- High Speed Switching Time
- Complementary to HEA1666

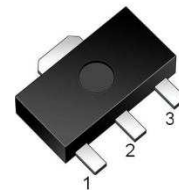

SOT-89

1:BASE 2:COLLECTOR 3:EMITTER

**MAXIMUM RATINGS ( $T_A = 25^\circ\text{C}$  unless otherwise noted)**

Parameter	Symbol	Value	Unit
Collector-Base Voltage	$V_{CBO}$	50	V
Collector-Emitter Voltage	$V_{CEO}$	50	V
Emitter-Base Voltage	$V_{EBO}$	5	V
Collector Current-Continuous	$I_C$	2	A
Collector Power Dissipation	$P_C$	500	mW
Junction Temperature	$T_J$	150	$^\circ\text{C}$
Storage Temperature	$T_{stg}$	-55~150	$^\circ\text{C}$

**ELECTRICAL CHARACTERISTICS ( $T_A=25^\circ\text{C}$  unless otherwise noted)**

Parameter	Symbol	Test conditions	Min	Typ	Max	Unit
Collector-Base Breakdown Voltage	$V_{CBO}$	$I_C=1\text{mA}, I_E=0$	50			V
Collector-Emitter Breakdown Voltage	$V_{CEO}$	$I_C=10\text{mA}, I_B=0$	50			V
Emitter-Base Breakdown Voltage	$V_{EBO}$	$I_E=1\text{mA}, I_C=0$	5			V
Collector Cut-off Current	$I_{CBO}$	$V_{CB}=50\text{V}, I_E=0$			0.1	$\mu\text{A}$
Emitter Cut-off Current	$I_{EBO}$	$V_{EB}=5\text{V}, I_C=0$			0.1	$\mu\text{A}$
DC Current Gain	$h_{FE(1)}$	$V_{CE}=2\text{V}, I_C=500\text{mA}$	70		240	
	$h_{FE(2)}$	$V_{CE}=2\text{V}, I_C=1.5\text{A}$	40			
Collector-Emitter Saturation Voltage	$V_{CE(sat)}$	$I_C=1\text{A}, I_B=50\text{mA}$			0.5	V
Base-Emitter Voltage	$V_{BE}$	$V_{CE}=1\text{A}, I_C=50\text{mA}$			1.2	V
Output Capacitance	$C_{ob}$	$V_{CB}=10\text{V}, I_E=0, f=1\text{MHz}$		30		PF
Transition Frequency	$f_T$	$V_{CE}=2\text{V}, I_C=500\text{mA}$		120		MHz

**CLASSIFICATION OF  $h_{FE}$** 

Rank	O	Y
Range	70-140	120-240
Marking	UO	UY

Typical Characteristics

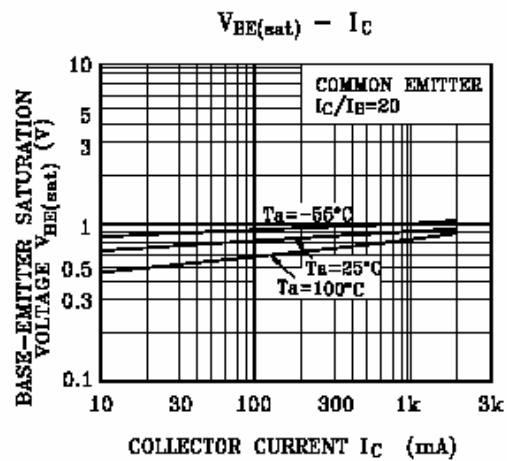
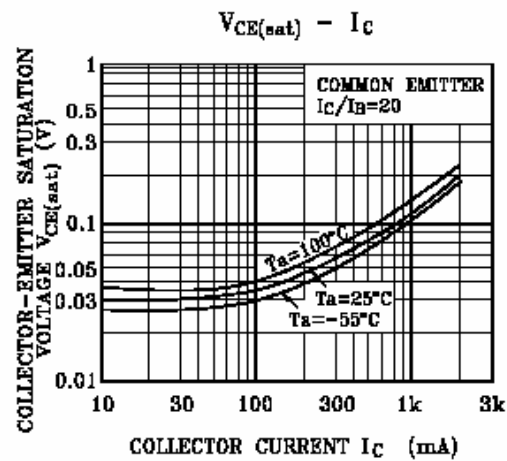
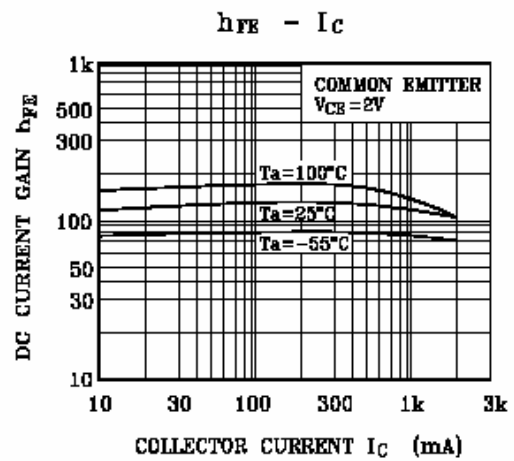
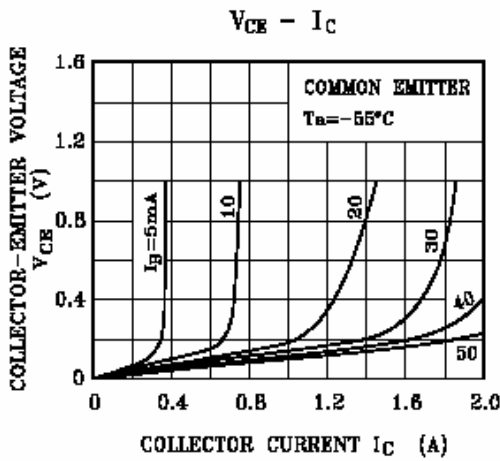
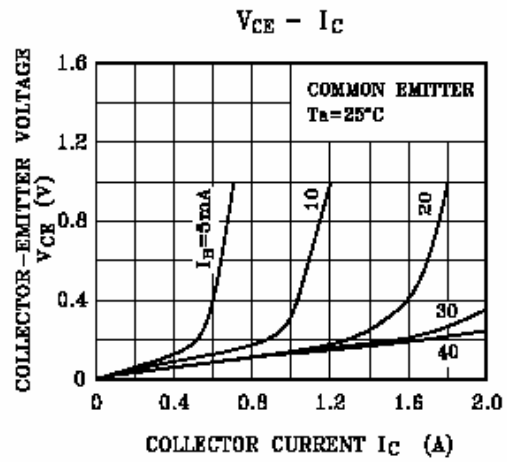
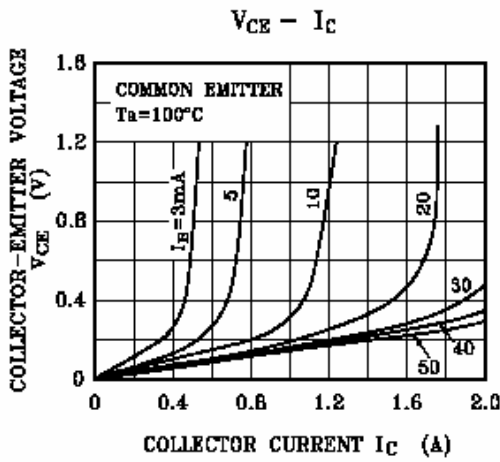

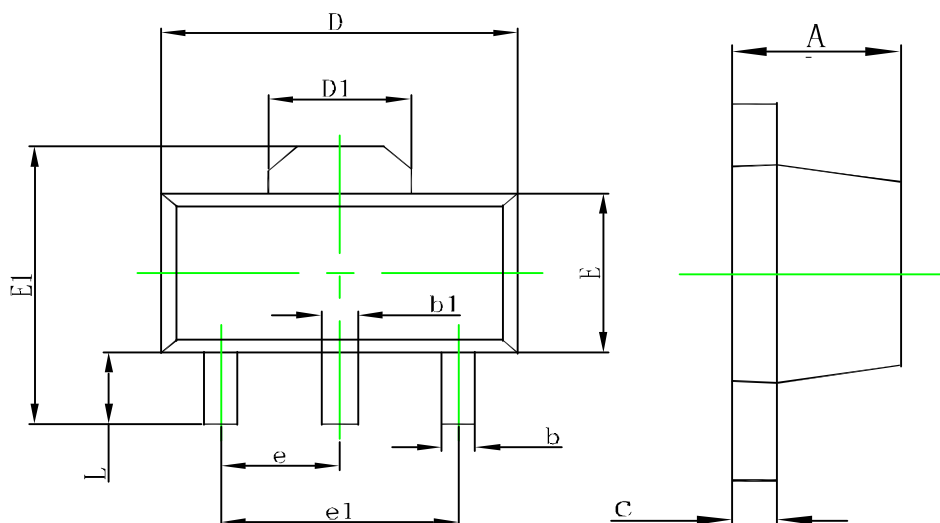
**SOT-89 Package Outline Dimensions**

Symbol	Dimensions In Millimeters		Dimensions In Inches	
	Min.	Max.	Min.	Max.
A	1.400	1.600	0.055	0.063
b	0.320	0.520	0.013	0.020
b1	0.400	0.580	0.016	0.023
c	0.350	0.440	0.014	0.017
D	4.400	4.600	0.173	0.181
D1	1.550REF.		0.061REF.	
E	2.300	2.600	0.091	0.102
E1	3.940	4.250	0.155	0.167
e	1.500TYP.		0.060TYP.	
e1	3.000TYP.		0.118TYP.	
L	0.900	1.200	0.035	0.047

**SOT-89 Tape and Reel**

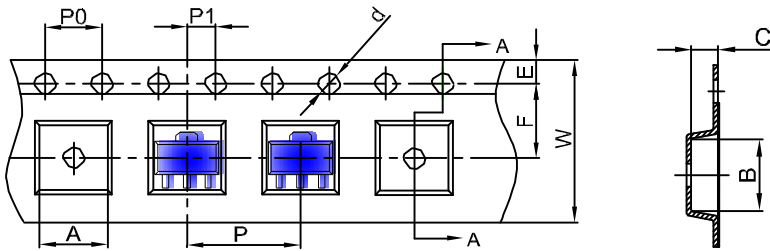

DIMENSIONS ARE IN MILLIMETER										
TYPE	A	B	C	d	E	F	P0	P	P1	W
SOT-89	4.85	4.45	1.85	φ1.50	1.75	5.50	4.00	8.00	2.00	12.00
TOLERANCE	±0.1	±0.1	±0.1	±0.1	±0.1	±0.1	±0.1	±0.1	±0.1	±0.1

**SOT-89 Tape Leader and Trailer**

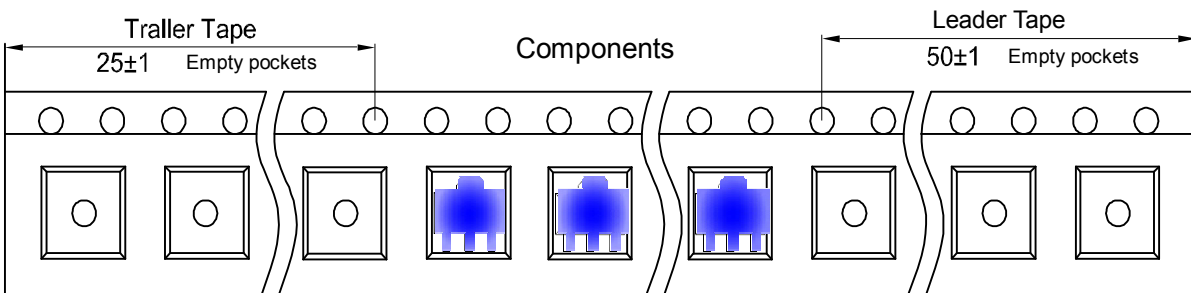

**SOT-89 Reel**

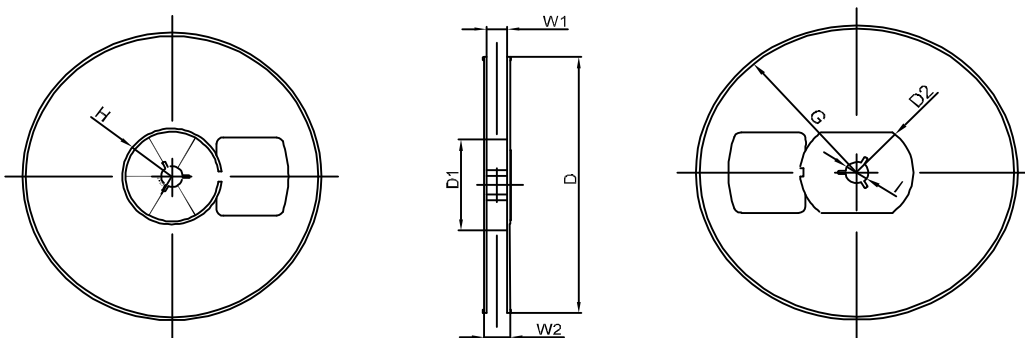

DIMENSIONS ARE IN MILLIMETER								
REEL OPTION	D	D1	D2	G	H	I	W1	W2
7" DIA	φ 180	60.00	R32.00	R86.50	R30.00	φ 13.00	13.20	16.50
TOLERANCE	±2	±1	±1	±1	±1	±1	±1	±1