



H2A1-H470



High Power single chip LED

H2A1-H470 is a InGaN based, high power 470 nm single chip LED in standard hexagonal Aluminum package for general application. Slots in the Aluminum-core PCB allow for easy mounting of standard collimating optics and are also suitable for M3 or M4 mounting screws. Large electrical interconnection pads on the PCB allow for convenient installation.

Specifications

- Structure: InGaN
- Peak Wavelength: 470 nm
- Optical Output Power: typ. 200 mW
- Life Time: > 10.000 hours
- **Lead free product - RoHS compliant**



Absolute Maximum Ratings (T_a=25°C)

Parameter	Symbol	Value	Unit
Power Dissipation, DC	P _D	1000	mW
Forward Current, DC	I _F	500	mA
Pulsed Current (1% duty cycle, 1kHz)	I _{FP}	1000	mA
Reverse Voltage	U _R	-5	V
Operating Temperature	T _{opr}	-30 ... +70	°C
Storage Temperature	T _{stg}	-30 ... +85	°C
Soldering Temperature (max. 1,5 s)	T _{sol}	330	°C

Electro-Optical Characteristics (T_a=25°C)

Parameter	Symbol	Condition	Min.	Typ.	Max.	Unit
Forward Current	I _F		-	350	-	mA
Viewing Angle	φ	I _F = 350 mA		± 75		deg.
CW Output Power	P _O	I _F = 350 mA		200		mW
Peak Wavelength	λ _P	I _F = 350 mA		470		nm
Forward Voltage	U _F	I _F = 350 mA	-	3.3	-	V
Half Width (FWHM)	Δλ	I _F = 350 mA	-	35		nm

Wavelength measurements tolerance is +/- 2%
Output power measurement tolerance is +/- 10%
Voltage measurement tolerance is +/- 2%

Device Materials

Item	Material
foundation	Plastic
Lens	Silicone resin
Electrodes	AgCu
PCB	Al

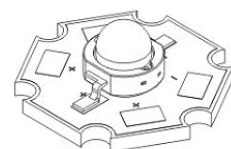



Typical Performance Characteristics

Normalized Output Power vs. Wavelength:

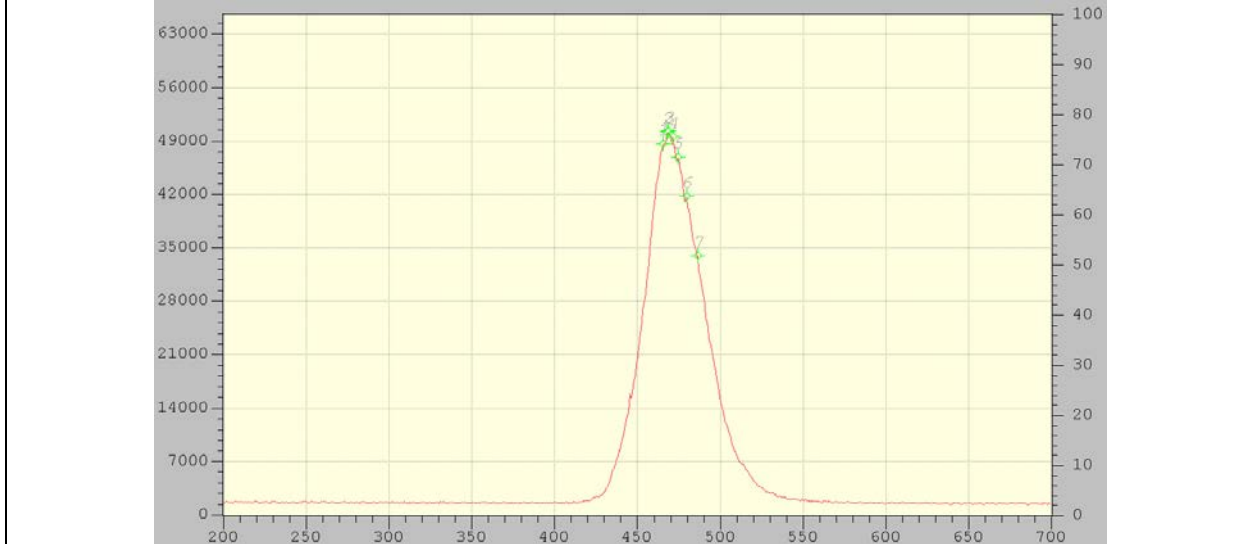

Outline Dimensions

Emitter:

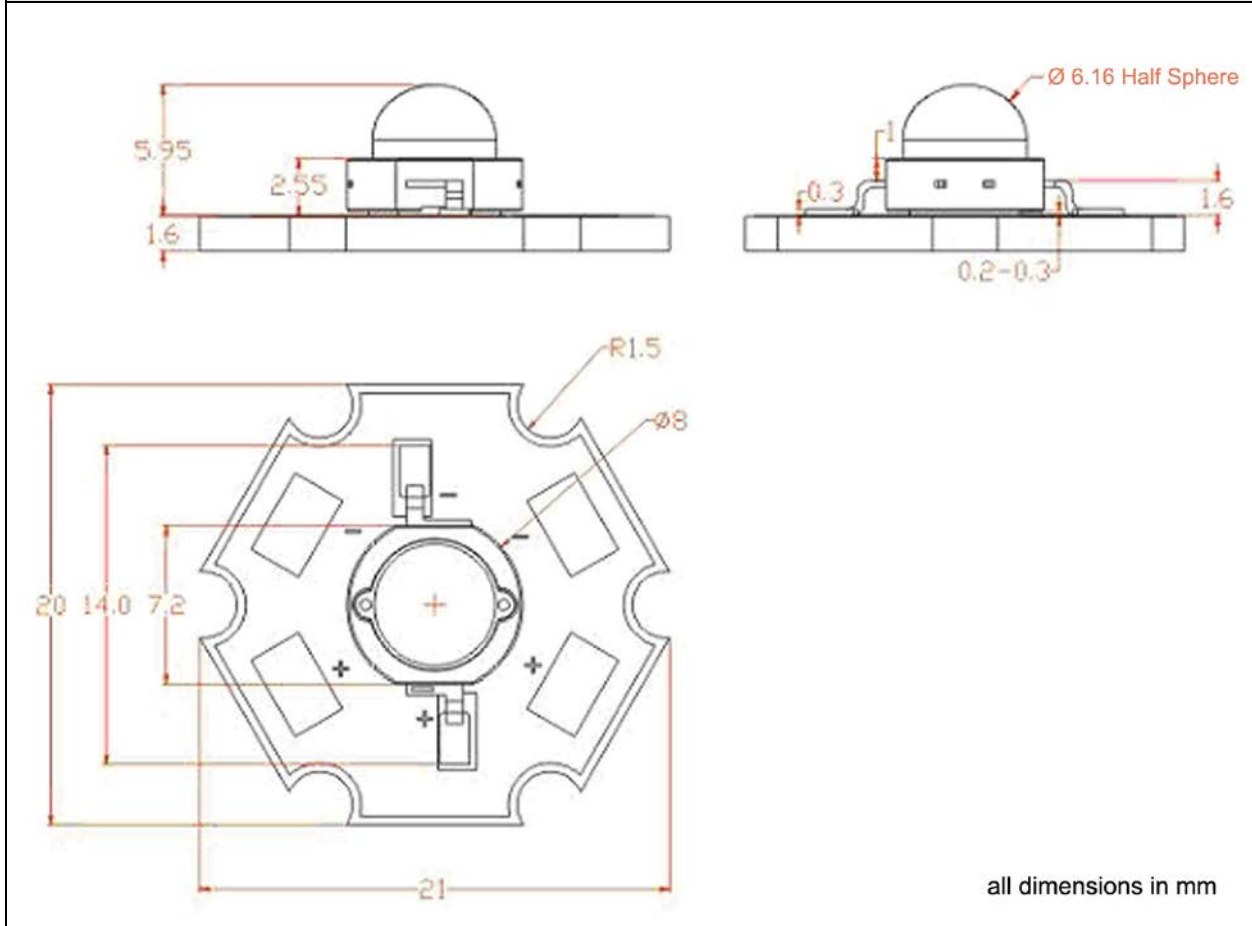



Radiation Pattern (Lambertian lens without optics)

Relative Intensity vs. Angular Displacement

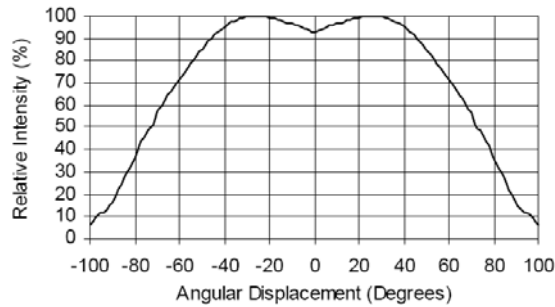

Accessories

Collimating optics, holders, reflectors

- 10158 + 10146, 2° half angle spot optic + optic holder
- 10048 + 10076, 4° half angle spot optic + optic holder
- 10003 + 10043, 6° half angle spot optic + optic holder
- 10003/15 + 10043, 15° half angle spot optic + optic holder
- 10003/25 + 10043, 25° half angle spot optic + optic holder
- CLP17CR, 6° metalized polycarbonate reflector
- CLP23CR, 20° metalized polycarbonate reflector



Static Electricity

LEDs are very sensitive to static Electricity and surge voltage. It is recommended to wear a wristband or an anti-electrostatic glove whenever handling the LEDs

All devices, equipment, and machinery that is used when handling the LEDs must be grounded properly.



Heat Generation

It is advised to operate these LEDs at a reasonable low temperature for long lifetime and stability. High operating temperature will result in premature degradation and shortened lifetime.





Soldering Conditions

Reflow Soldering:

APG2C1 LEDs have a maximum storage temperature of 85°. Therefore it is not possible to use a reflow soldering process for array assembly!

Hot Bar Soldering:

A Hot Bar Soldering process is recommended when soldering APG2C1 emitters. This process will only transfer heat to the leads and avoids overheating the emitter which will damage the device. In order to transfer sufficient heat from the hot bar to the device, following parameters must be carefully considered:

- Amount of flux
- Pressing force of solder tip
- Hot bar temperature

For the standard assembly process, following parameters should be maintained:

- Hot Bar temperature: 330 °C
- Force of Hot Bar: 40 N
- Soldering time: 1.5 s

It is recommended to use a copper nickel-plated hot bar mounted to standard temperature controlled soldering equipment.

Manual Hand Soldering:

For prototype build or small series production runs, it is possible to place and solder the emitters by hand. It is therefore recommended to maintain the following parameters:

- Solder Tip Temperature 330 °C
- Soldering time: < 1.5 s
- Junction temperature must be kept below 70 °C

A visual inspection may be used to check the quality of the solder joint

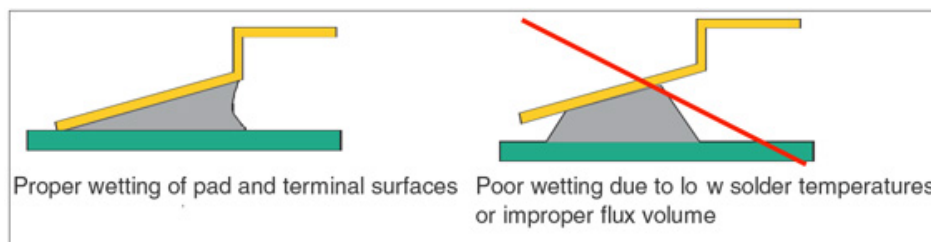

General Soldering Precautions:

- Mechanical stress, shock and vibration must be avoided during soldering
- Only use non corrosive flux.
- Do not apply current to the device until it has cooled down to room temperature after soldering.