

1 - Cathode
2 - Anode
Back of Case - Cathode

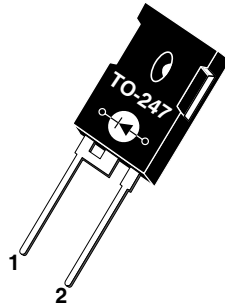

APT100S20B(G) 200V 120A

*G Denotes RoHS Compliant, Pb Free Terminal Finish.

HIGH VOLTAGE SCHOTTKY DIODE

| PRODUCT APPLICATIONS | PRODUCT FEATURES | PRODUCT BENEFITS |
|---|--|---|
| <ul style="list-style-type: none"> • Parallel Diode <ul style="list-style-type: none"> -Switchmode Power Supply -Inverters • Free Wheeling Diode <ul style="list-style-type: none"> -Motor Controllers -Converters • Snubber Diode • Uninterruptible Power Supply (UPS) • 48 Volt Output Rectifiers • High Speed Rectifiers | <ul style="list-style-type: none"> • Ultrafast Recovery Times • Soft Recovery Characteristics • Popular TO-247 Package or Surface Mount D²PAK Package • Low Forward Voltage • High Blocking Voltage • Low Leakage Current | <ul style="list-style-type: none"> • Low Losses • Low Noise Switching • Cooler Operation • Higher Reliability Systems • Increased System Power Density |

MAXIMUM RATINGS

All Ratings: $T_C = 25^\circ\text{C}$ unless otherwise specified.

| Symbol | Characteristic / Test Conditions | APT100S20B(G) | UNIT |
|----------------|--|---------------|------------------|
| V_R | Maximum D.C. Reverse Voltage | 200 | Volts |
| V_{RRM} | Maximum Peak Repetitive Reverse Voltage | | |
| V_{RWM} | Maximum Working Peak Reverse Voltage | | |
| $I_{F(AV)}$ | Maximum Average Forward Current ^① ($T_C = 125^\circ\text{C}$, Duty Cycle = 0.5) | 120 | Amps |
| $I_{F(RMS)}$ | RMS Forward Current (Square wave, 50% duty) ^① | 318 | |
| I_{FSM} | Non-Repetitive Forward Surge Current ($T_J = 45^\circ\text{C}$, 8.3ms) | 1000 | |
| T_J, T_{STG} | Operating and Storage Temperature Range | -55 to 150 | $^\circ\text{C}$ |
| T_L | Lead Temperature for 10 Sec. | 300 | |
| E_{VAL} | Avalanche Energy (2A, 50mH) | 100 | |

STATIC ELECTRICAL CHARACTERISTICS

| Symbol | | MIN | TYP | MAX | UNIT | |
|----------|---|-----|--|------|------|-------|
| V_F | Forward Voltage | | $I_F = 100\text{A}$ | .89 | .95 | Volts |
| | | | $I_F = 200\text{A}$ | 1.06 | | |
| | | | $I_F = 100\text{A}, T_J = 125^\circ\text{C}$ | .76 | | |
| I_{RM} | Maximum Reverse Leakage Current | | $V_R = 200\text{V}$ | | 2 | mA |
| | | | $V_R = 200\text{V}, T_J = 125^\circ\text{C}$ | | 40 | |
| C_T | Junction Capacitance, $V_R = 200\text{V}$ | | 470 | | pF | |

| Symbol | Characteristic | Test Conditions | MIN | TYP | MAX | UNIT |
|-----------|----------------------------------|--|-----|------|-----|------|
| t_{rr} | Reverse Recovery Time | $I_F = 100A, di_F/dt = -200A/\mu s$ $V_R = 133V, T_C = 25^\circ C$ | - | 70 | | ns |
| Q_{rr} | Reverse Recovery Charge | | - | 230 | | nC |
| I_{RRM} | Maximum Reverse Recovery Current | | - | 6 | - | Amps |
| t_{rr} | Reverse Recovery Time | $I_F = 100A, di_F/dt = -200A/\mu s$ $V_R = 133V, T_C = 125^\circ C$ | - | 110 | | ns |
| Q_{rr} | Reverse Recovery Charge | | - | 690 | | nC |
| I_{RRM} | Maximum Reverse Recovery Current | | - | 11 | - | Amps |
| t_{rr} | Reverse Recovery Time | $I_F = 100A, di_F/dt = -700A/\mu s$ $V_R = 133V, T_C = 125^\circ C$ | - | 95 | | ns |
| Q_{rr} | Reverse Recovery Charge | | - | 1750 | | nC |
| I_{RRM} | Maximum Reverse Recovery Current | | - | 32 | | Amps |

THERMAL AND MECHANICAL CHARACTERISTICS

| Symbol | Characteristic / Test Conditions | MIN | TYP | MAX | UNIT |
|-----------------|-------------------------------------|-----|------|-----|--------------|
| $R_{\theta JC}$ | Junction-to-Case Thermal Resistance | | | .18 | $^\circ C/W$ |
| W_T | Package Weight | | 0.22 | | oz |
| | | | 5.9 | | g |
| Torque | Maximum Mounting Torque | | | 10 | lb•in |
| | | | | 1.1 | N•m |

Microsemi reserves the right to change, without notice, the specifications and information contained herein.

① Continuous current limited by package lead temperature.

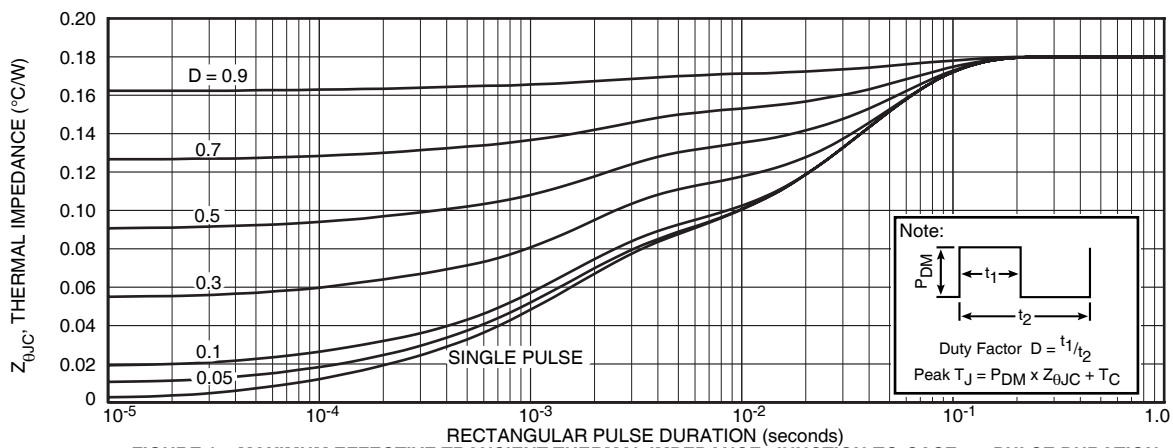
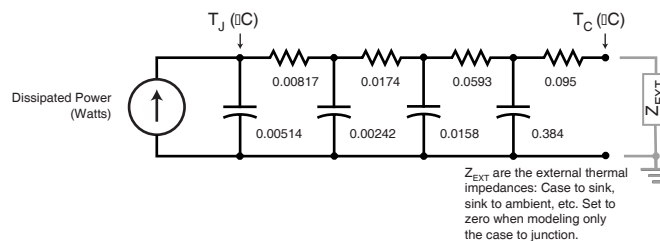

FIGURE 1a. MAXIMUM EFFECTIVE TRANSIENT THERMAL IMPEDANCE, JUNCTION-TO-CASE vs. PULSE DURATION



Z_{EXT} are the external thermal impedances: Case to sink, sink to ambient, etc. Set to zero when modeling only the case to junction.

FIGURE 1b. TRANSIENT THERMAL IMPEDANCE MODEL

TYPICAL PERFORMANCE CURVES

APT100S20B(G)

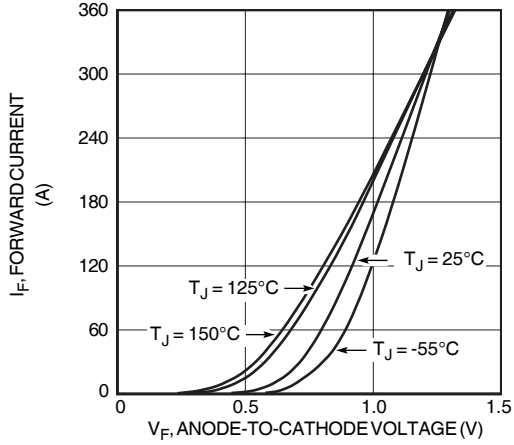

Figure 2. Forward Current vs. Forward Voltage

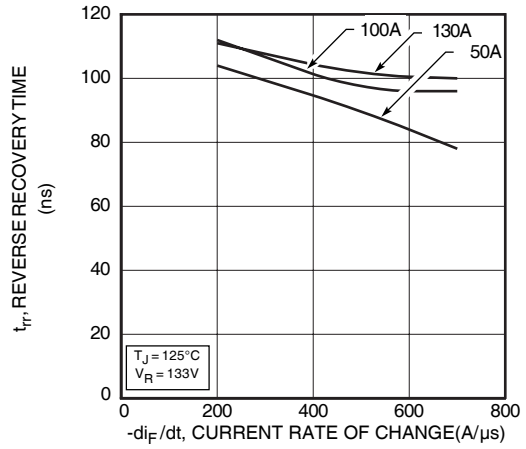

Figure 3. Reverse Recovery Time vs. Current Rate of Change

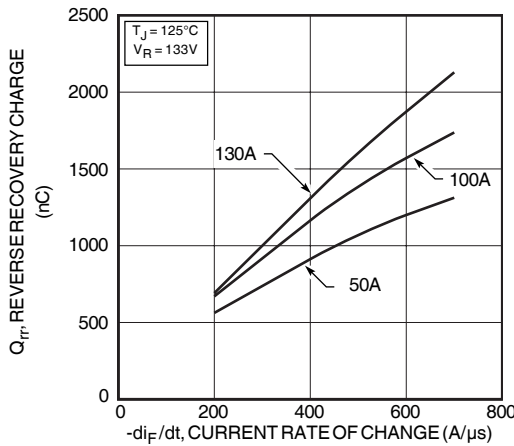

Figure 4. Reverse Recovery Charge vs. Current Rate of Change

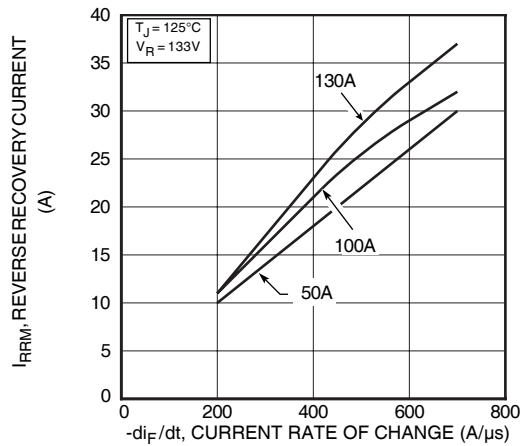

Figure 5. Reverse Recovery Current vs. Current Rate of Change

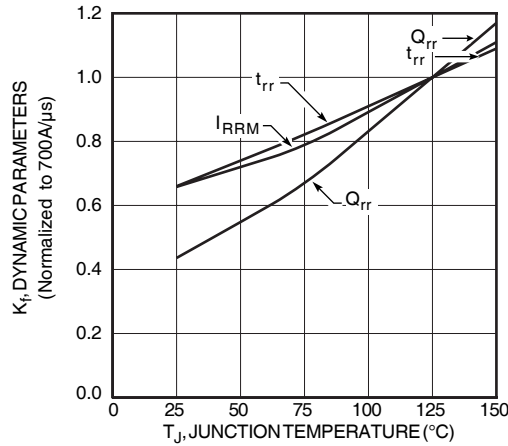

Figure 6. Dynamic Parameters vs. Junction Temperature

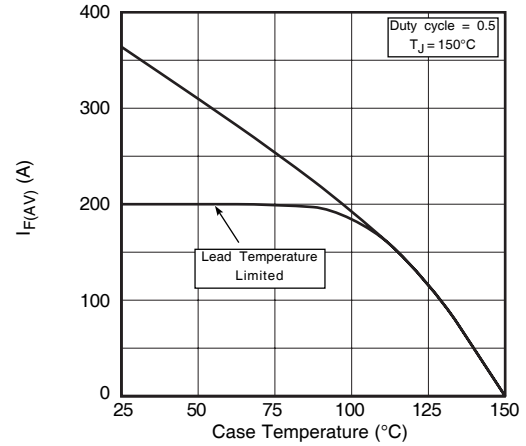

Figure 7. Maximum Average Forward Current vs. Case Temperature

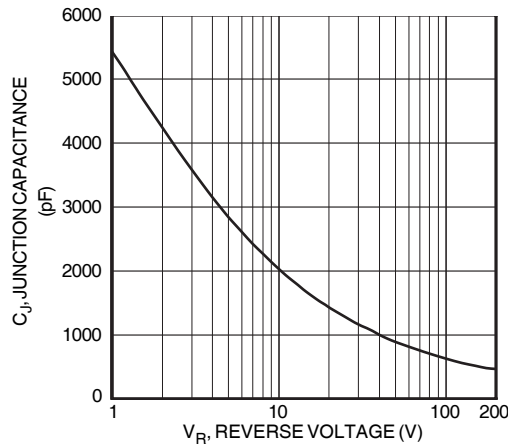

Figure 8. Junction Capacitance vs. Reverse Voltage

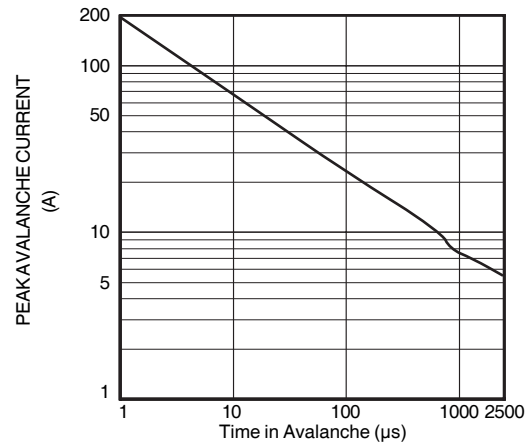

Figure 9. Single Pulse UIS SOA

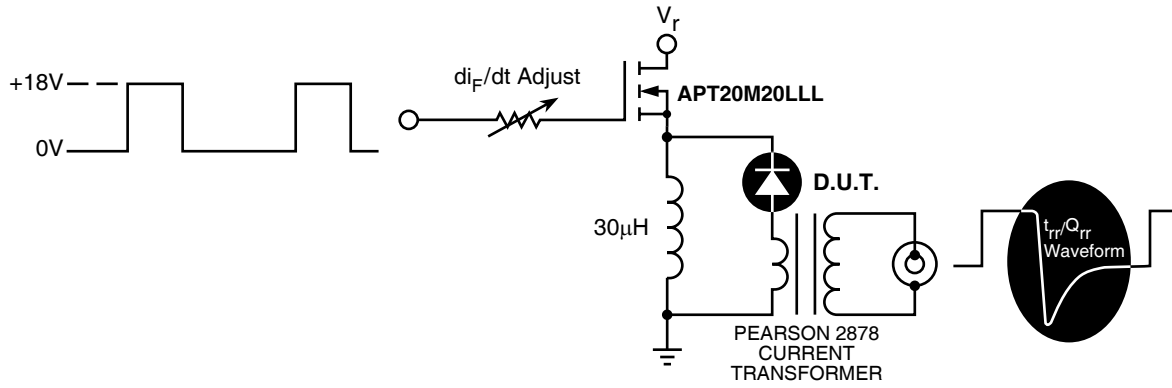

Figure 9. Diode Test Circuit

- 1 I_F - Forward Conduction Current
- 2 di_F/dt - Rate of Diode Current Change Through Zero Crossing.
- 3 I_{RRM} - Maximum Reverse Recovery Current.
- 4 t_{rr} - Reverse Recovery Time, measured from zero crossing where diode current goes from positive to negative, to the point at which the straight line through I_{RRM} and $0.25 \cdot I_{RRM}$ passes through zero.
- 5 Q_{rr} - Area Under the Curve Defined by I_{RRM} and t_{rr} .

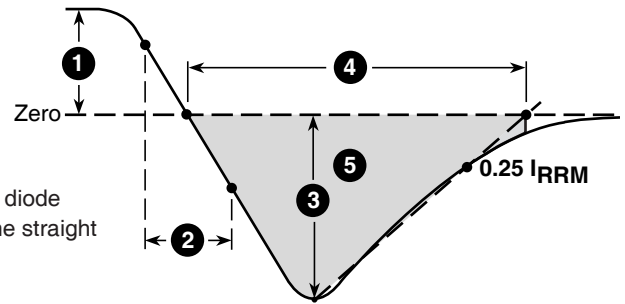
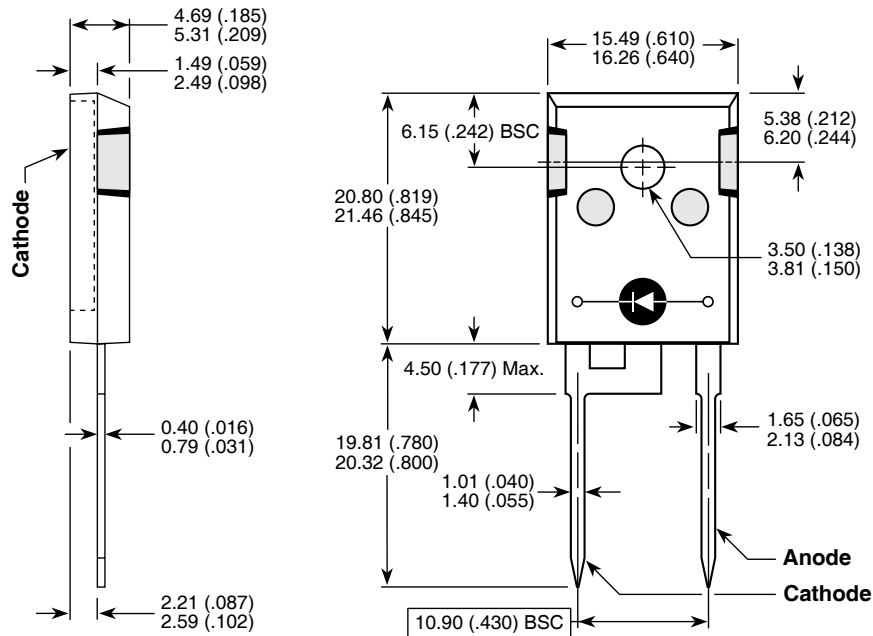

Figure 10, Diode Reverse Recovery Waveform and Definitions

TO-247 Package Outline

e1 SAC: Tin, Silver, Copper



Dimensions in Millimeters and (Inches)