



SB5100L

LOW VF SCHOTTKY BARRIER RECTIFIERS

VOLTAGE 100 Volt **CURRENT** 5 Ampere

FEATURES

- Plastic package has Underwriters Laboratory Flammability Classification 94V-O utilizing Flame Retardant Epoxy Molding Compound.
- For use in low voltage, high frequency inverters, free wheeling, and polarity protection applications .
- Lead free in compliance with EU RoHS 2011/65/EU directive

MECHANICAL DATA

- Case: DO-201AD Molded plastic
- Terminals: Axial leads, solderable per MIL-STD-750, Method 2026
- Polarity: Color band denotes cathode
- Weight: 0.0403 ounces, 1.142 grams

DO-201AD Unit : inch(mm)

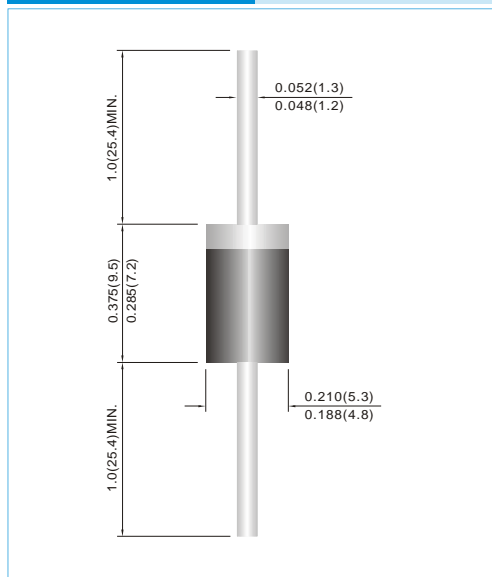

MAXIMUM RATINGS(T_A=25°C unless otherwise noted)

PARAMETER	SYMBOL	VALUE	UNIT
Maximum repetitive peak reverse voltage	V _{RRM}	100	V
Maximum rms voltage	V _{RMS}	70	V
Maximum average forward rectified current	I _{F(AV)}	5	A
Peak forward surge current 8.3ms single half sine-wave superimposed on rated load	I _{FSM}	250	A
Typical Thermal Resistance	R _{θJA}	45	°C/W
Operating junction temperature range	T _J	-55 to + 150	°C
Storage temperature range	T _{STG}	-55 to + 150	°C

ELECTRICAL CHARACTERISTICS(T_A=25°C unless otherwise noted)

PARAMETER	SYMBOL	TEST CONDITIONS	TYP.	MAX.	UNIT	
Breakdown voltage	V _{BR}	I _R =0.5mA T _J =25°C	100	-	V	
Instantaneous forward voltage	V _F	I _F =1A T _J =25°C	0.44	-	V	
		I _F =3A T _J =25°C	0.58	-		
		I _F =5A T _J =25°C	0.68	0.70		
		I _F =1A T _J =125°C	0.35	-	V	
I _F =3A T _J =125°C	0.49	-				
I _F =5A T _J =125°C	0.56	0.6				
Reverse current	I _R	V _R =70V T _J =25°C	10	-	μA	
		V _R =100V	T _J =25°C	-	50	μA
			T _J =100°C	-	10	mA
			T _J =125°C	-	50	mA



SB5100L

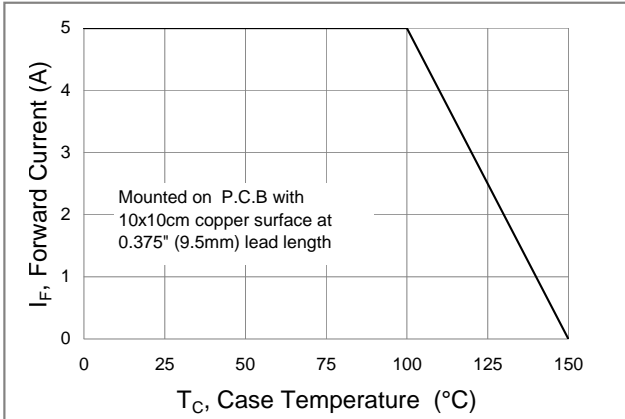

Fig.1 Forward Current Derating Curve

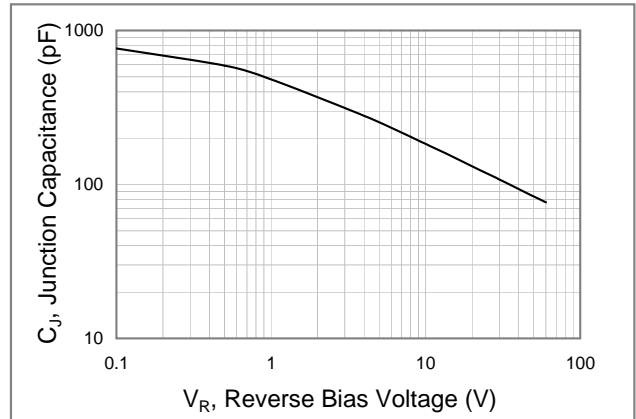

Fig.2 Typical Junction Capacitance

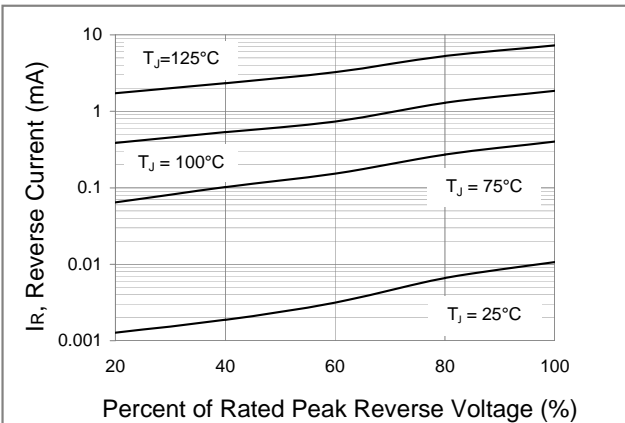

Fig.3 Typical Reverse Characteristics

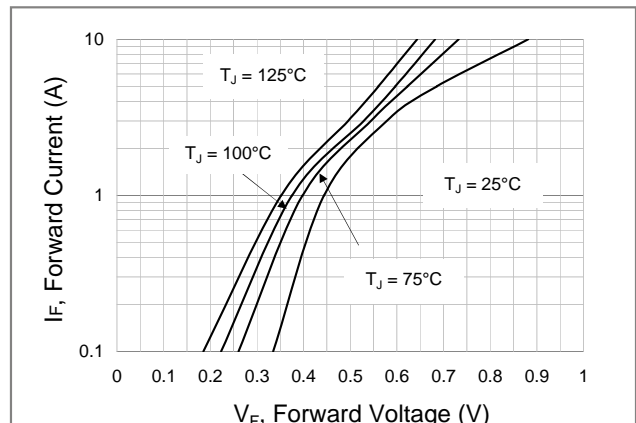

Fig.4 Typical Forward Characteristics

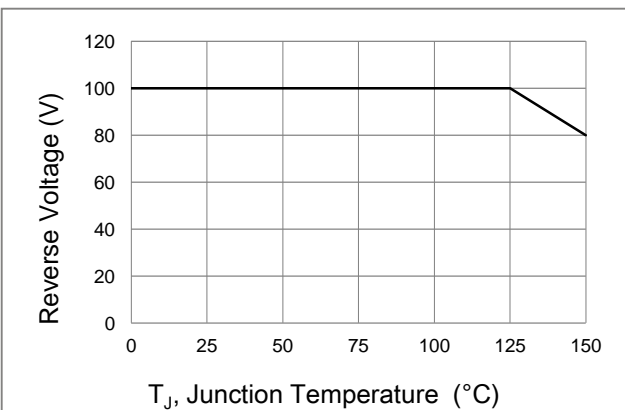

Fig.5 Operating Temperature Derating Curve



SB5100L

Part No_packing code_Version

SB5100L_AY_00001
 SB5100L_AY_10001
 SB5100L_B0_00001
 SB5100L_B0_10001
 SB5100L_R2_00001
 SB5100L_R2_10001

For example :

RB500V-40_R2_00001

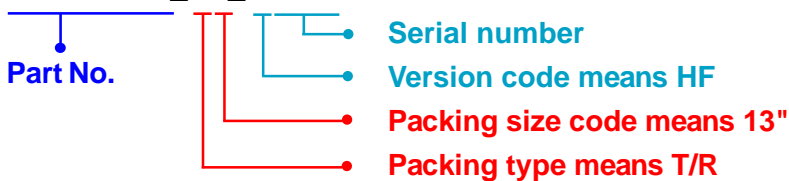

Packing Code XX				Version Code XXXXX		
Packing type	1 st Code	Packing size code	2 nd Code	HF or RoHS	1 st Code	2 nd ~5 th Code
Tape and Ammunition Box (T/B)	A	N/A	0	HF	0	serial number
Tape and Reel (T/R)	R	7"	1	RoHS	1	serial number
Bulk Packing (B/P)	B	13"	2			
Tube Packing (T/P)	T	26mm	X			
Tape and Reel (Right Oriented) (TRR)	S	52mm	Y			
Tape and Reel (Left Oriented) (TRL)	L	PANASERT T/B CATHODE UP (PBCU)	U			
FORMING	F	PANASERT T/B CATHODE DOWN (PBCD)	D			



SB5100L

Disclaimer

- Reproducing and modifying information of the document is prohibited without permission from Panjit International Inc..
- Panjit International Inc. reserves the rights to make changes of the content herein the document anytime without notification. Please refer to our website for the latest document.
- Panjit International Inc. disclaims any and all liability arising out of the application or use of any product including damages incidentally and consequentially occurred.
- Panjit International Inc. does not assume any and all implied warranties, including warranties of fitness for particular purpose, non-infringement and merchantability.
- Applications shown on the herein document are examples of standard use and operation. Customers are responsible in comprehending the suitable use in particular applications. Panjit International Inc. makes no representation or warranty that such applications will be suitable for the specified use without further testing or modification.
- The products shown herein are not designed and authorized for equipments requiring high level of reliability or relating to human life and for any applications concerning life-saving or life-sustaining, such as medical instruments, transportation equipment, aerospace machinery et cetera. Customers using or selling these products for use in such applications do so at their own risk and agree to fully indemnify Panjit International Inc. for any damages resulting from such improper use or sale.
- Since Panjit uses lot number as the tracking base, please provide the lot number for tracking when complaining.