

"High Frequency Ceramic Solutions"

NFC antenna with ferrite shielding feature for over-metal/battery/rugged/industrial/ home/automotive and extended reading distance environments.

P/N NFC1AT80A01N7

Applications: Lock Access, Pairing, Data Communications, Payment systems, RFID

Detail Specification: 1/7/2016

Page 1 of 5

For optimized reading distance and speed, other inductance values¹ may be selected, go to: www.johansontechnology.com/antennas

General Specifications	
Part Number	NFC1AT80A01N7
Frequency (MHz)	13.56
Reading Distance ² (mm)	>40 EMVCO >20 Card (Avg)
Inductance @ 13.56MHz	1.7 ±10% µH
Quality Factor @ 13.56 MHz	>30

¹Depending on design and end product environment

²Reading distance measured using QP3000 and NXP-PN65N

Part Number Explanation				
P/N	Packing	Bulk (loose)	Suffix = S	eg. NFC1AT80A01N7S
Suffix	Style	Trays	Suffix = E	eg. NFC1AT80A01N7E

Mechanical Dimensions		
	In	mm
L	1.969 ± 0.012	50.00 ± 0.30
W	1.181 ± 0.012	30.00 ± 0.30
A	0.256 ± 0.012	6.50 ± 0.30
B	0.354 ± 0.008	9.00 ± 0.20
T	0.015 Max.	0.38 Max.
a	0.177 ± 0.012	4.50 ± 0.30
b	0.118 ± 0.012	3.00 ± 0.30
c	0.039 ± 0.012	1.00 ± 0.30
d	0.039 ± 0.012	1.00 ± 0.30
e	0.039 ± 0.012	1.00 ± 0.30

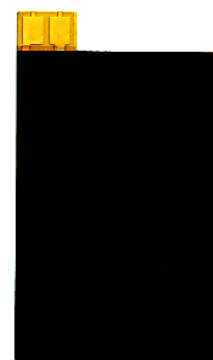
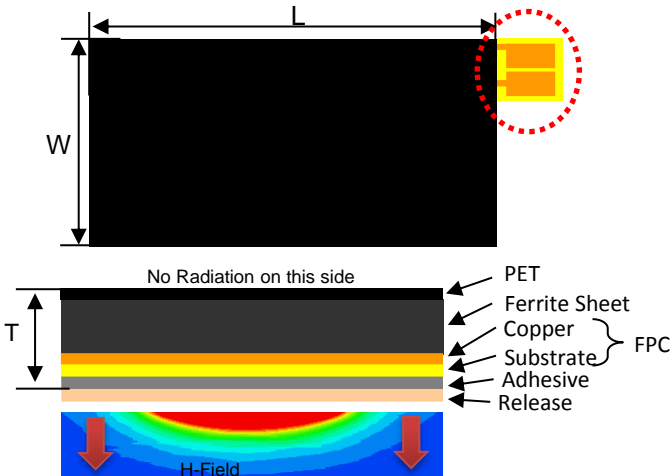
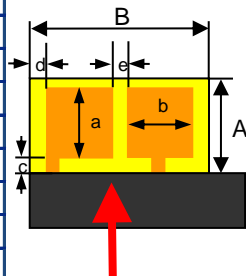

- Applications**
- Data Communications
 - Lock entry systems
 - Payment systems
 - RFID Tags reader/writer
 - Instant, High Data Rate transfers
 - Contactless smart cards
 - Transit Access systems
 - Security

Terminal/Contact Pads' Configuration	
No.	Function
1	Feed
2	Feed

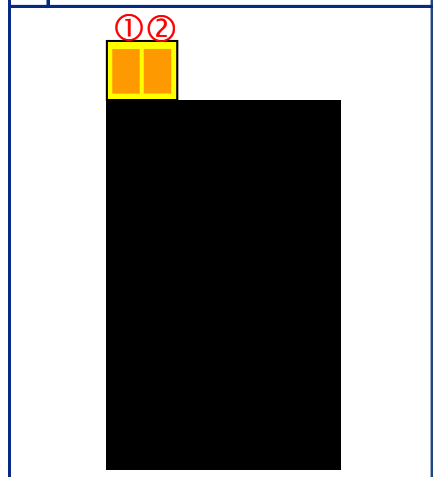

*Feed 1/2 interchangeable



www.johansontechnology.com
4001 Calle Tecate • Camarillo, CA 93012 • TEL 805.389.1166 FAX 805.389.1821

Ver 1.1 2014 Johanson Technology, Inc. All Rights Reserved

"High Frequency Ceramic Solutions"

NFC antenna with ferrite shielding feature for over-metal/battery/rugged/industrial/ home/automotive and extended reading distance environments.

P/N NFC1AT80A01N7

Applications: Lock Access, Pairing, Data Communications, Payment systems, RFID

Detail Specification: 1/7/2016

Page 2 of 5

For optimized reading distance and speed, other inductance values¹ may be selected, go to: www.johansontechnology.com/antennas

Typical Electrical Characteristics (T=25 °C) without metal plane

Antenna Inductance (uH)

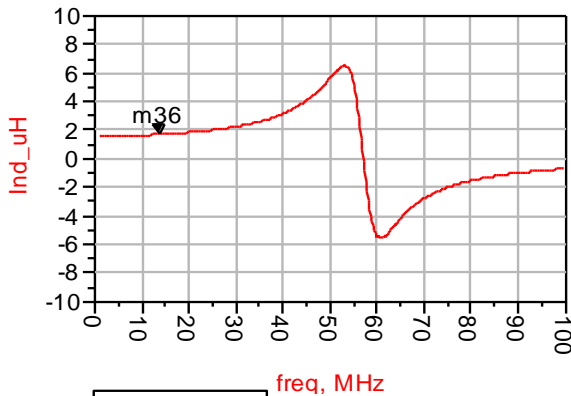

m36
freq=13.56MHz
Ind_uH=1.701

Features

- Can be mounted on top of metal
- Available in various inductance values depending on environment
- No custom antenna layout design needed
- Near field inductive coupling
- Ferromagnetic material for fast, instant coupling
- Shape, dimensions and matching circuit design for easy integration of all 13.56MHz NFC applications
- Thin profile

Antenna Impedance (Ohms)

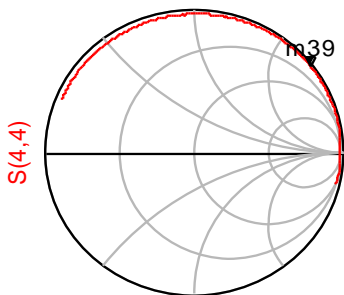

freq (1.000MHz to 100.0MHz)

m39
freq=13.56MHz
S(4,4)=0.988 / 38.062
impedance = 2.865 + j144.90

Radiation Direction (H Field $\geq 1.5A/m$)

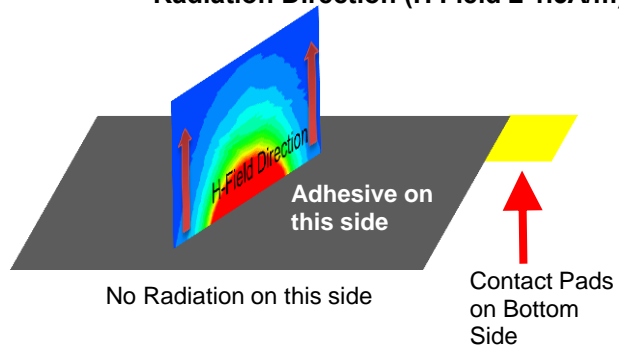

¹Depending on design and end product environment

Johanson Technology, Inc. reserves the right to make design changes without notice. Please confirm the specifications and delivery conditions when placing your order. All sales are subject to Johanson Technology, Inc. terms and conditions.

"High Frequency Ceramic Solutions"

NFC antenna with ferrite shielding feature for over-metal/battery/rugged/industrial/ home/automotive and extended reading distance environments.

P/N NFC1AT80A01N7

Applications: Lock Access, Pairing, Data Communications, Payment systems, RFID

Detail Specification: 1/7/2016

Page 3 of 5

For optimized reading distance and speed, other inductance values¹ may be selected, go to: www.johansontechnology.com/antennas

Antenna Matching Application Note

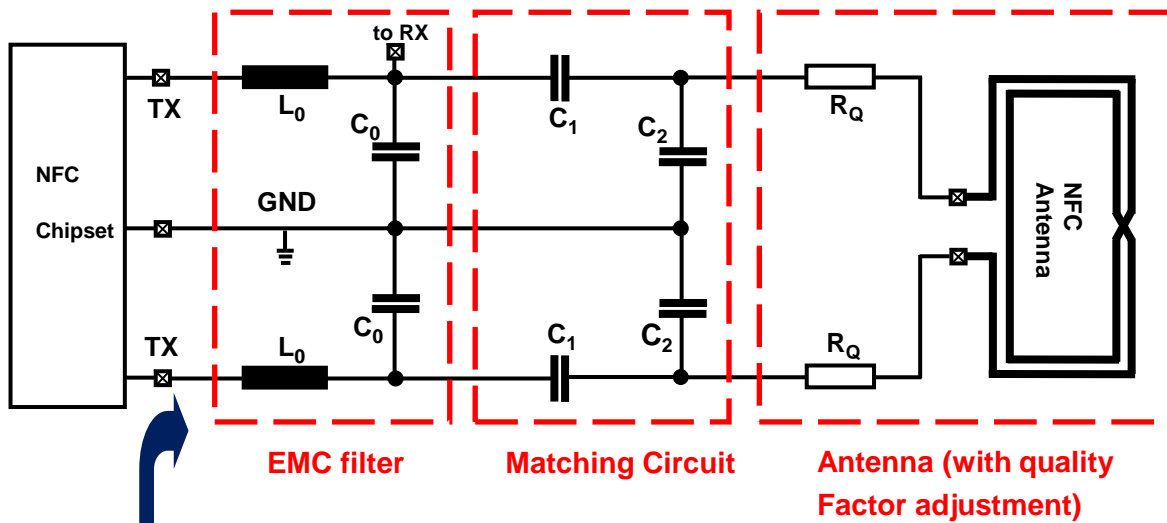

Matching resistance R_{match} at 13.56MHz

Component	Note
L_0	The EMC filter is used to reduce harmonics of the 13.56 MHz carriers and perform as an impedance transformer
C_0	
C_1	The matching circuit elements C_1 and C_2 must be tuned to get the required matching resistance R_{match} ($X_{match}=0$) at the I/O pins of NFC IC
C_2	
R_q	The quality factor damping resistors RQ are used to obtain a certain pulse shape as required by the standard. Normally, RQ is chosen to make the antenna $Q < 35$

Let us help you tune your antenna for proper operation and maximum readout distance!

Details here: www.johansontechnology.com/ipc-antenna-services

Contact our RF Engineers here: <http://www.johansontechnology.com/ask-a-question>

¹Depending on design and end product environment

Johanson Technology, Inc. reserves the right to make design changes without notice. Please confirm the specifications and delivery conditions when placing your order. All sales are subject to Johanson Technology, Inc. terms and conditions.



www.johansontechnology.com

4001 Calle Tecate • Camarillo, CA 93012 • TEL 805.389.1166 FAX 805.389.1821

Ver 1.1

2014 Johanson Technology, Inc. All Rights Reserved

"High Frequency Ceramic Solutions"

NFC antenna with ferrite shielding feature for over-metal/battery/rugged/industrial/ home/automotive and extended reading distance environments.

P/N NFC1AT80A01N7

Applications: Lock Access, Pairing, Data Communications, Payment systems, RFID

Detail Specification: 1/7/2016

Page 4 of 5

For optimized reading distance and speed, other inductance values¹ may be selected, go to: www.johansontechnology.com/antennas

Cable Recommendation

When deciding what type of cable is best for your application, there are a few key factors to keep in mind. While a larger gauge cable provides lower losses, they are typically more rigid and difficult to bend. The opposite is true for thinner gauge wires in that they are more flexible at the cost of increased loss. **For this reason, we feel that the 1.13 mm micro coax cable strikes the best balance between performance, flexibility, and even cost.**

We recommend a minimum cable length of 10cm. This helps to reduce stress that the cable experiences when connecting to the main PCB. And while there isn't a maximum length, keep in mind that increased cable length does contribute to increased loss.

Cable Soldering

We recommend directly soldering the RF cable onto the NFC antenna pads

1. Strip RF cable exposing roughly 2mm of each layer
2. Solder center conductor to one of the feeds (the two are interchangeable)
3. Solder the braided shield to the remaining feed (the two are interchangeable)
4. Ensure solid solder joints between cable and corresponding NFC feeds



¹Depending on design and end product environment

Johanson Technology, Inc. reserves the right to make design changes without notice. Please confirm the specifications and delivery conditions when placing your order. All sales are subject to Johanson Technology, Inc. terms and conditions.



www.johansontechnology.com

4001 Calle Tecate • Camarillo, CA 93012 • TEL 805.389.1166 FAX 805.389.1821

Ver 1.1

2014 Johanson Technology, Inc. All Rights Reserved

"High Frequency Ceramic Solutions"

NFC antenna with ferrite shielding feature for over-metal/battery/rugged/industrial/ home/automotive and extended reading distance environments.

P/N NFC1AT80A01N7

Applications: Lock Access, Pairing, Data Communications, Payment systems, RFID

Detail Specification: 1/7/2016

Page 5 of 5

For layout positioning review assistance, contact our Applications Team at:

www.johansontechnology.com/component/techquestion

For more antennas and download measured S-parameters, go to:

www.johansontechnology.com/antennas

RoHS Compliance

www.johansontechnology.com/technical-notes/rohs-compliance.html

MSL Info

www.johansontechnology.com/technical-notes/msl-rating.html

Packaging information

www.johansontechnology.com/ipcpackaging.html

Soldering Information

www.johansontechnology.com/ipcsoldering-profile

Recommended Storage Condition and Max Shelf Life

www.johansontechnology.com/ipcstorage-shelflife

Why use a Ferrite Shielded NFC antenna Vs a regular flex PCB NFC antenna?

- When a metal-content object (i.e. battery, plate, GND PCB, LCD display) is placed near, above underneath the NFC antenna, the magnetic field will generate undesired EM current on metal plate, which are called eddy currents which will not permit communication unless customization is done
- These eddy currents will absorb power, weaken the E-field and lead to detuning of the antenna, rendering it non-operational
- Most of the time it is necessary to "load" or "shield" the antenna with ferrite or other mechanically precise metals for proper operation in metallic environments/layouts

End Product Examples

Payment Terminal	Tablets/Notebooks
Transit access receivers	Lock/Security Systems
Smartphones	In-store reward tags
Wearables/Fitness Reader	Vehicle entry locks



Johanson Technology, Inc. reserves the right to make design changes without notice. Please confirm the specifications and delivery conditions when placing your order. All sales are subject to Johanson Technology, Inc. terms and conditions.

JOHANSON
TECHNOLOGY 

www.johansontechnology.com

4001 Calle Tecate • Camarillo, CA 93012 • TEL 805.389.1166 FAX 805.389.1821

Ver 1.1

2014 Johanson Technology, Inc. All Rights Reserved