

# NewJRC SAW FILTER

## NSVS1103

Application

**314.35MHz R.K.E.**

Electrical Specification: (Table 1)

The device characteristics are measured in the circuit shown in Fig.1.

Table 1. Electrical Specifications

Item		Spec.	Typ.
Input and Output Impedance		50Ω	-
Nominal Center Frequency (f0)		314.35MHz	-
Insertion Loss	313.85~314.85MHz	3.0dB max.	2.0dB
Response Variation	313.85~314.85MHz	1.5dB max.	0.8dB
Input and Output VSWR	313.85~314.85MHz	2.5 max.	1.8
Out of Band Rejection (Relative to Through Level)	292.95 MHz	50dB min.	60dB
	335.75 MHz	40dB min.	45dB

(Operating Temperature Range: -40~+85°C)

Maximum Rating: (Table 2)

Table 2. Maximum Ratings

Item	Rating
Maximum Input Power	+20dBm
Maximum DC Voltage	7.5V
Operating Temperature Range	-40~+85°C
Storage Temperature	-45~+90°C

Mechanical Specifications: (Fig.2)

Package is designed as small as 3.0x3.0x1.15[mm<sup>3</sup>] for SMD (Surface Mount Device) type.

**Notice:**

This part is electrostatic discharge sensitive and may be damaged by improper handling.

*New Japan Radio Co., Ltd.*

<http://www.njr.co.jp/products/device/index.html>

(Japanese)

<http://www.njr.com/products/device/index.html>

(English)

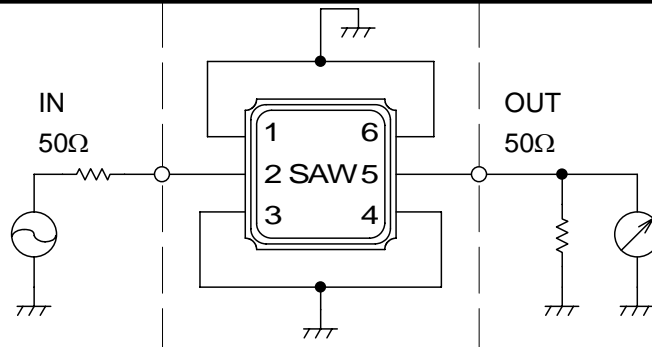
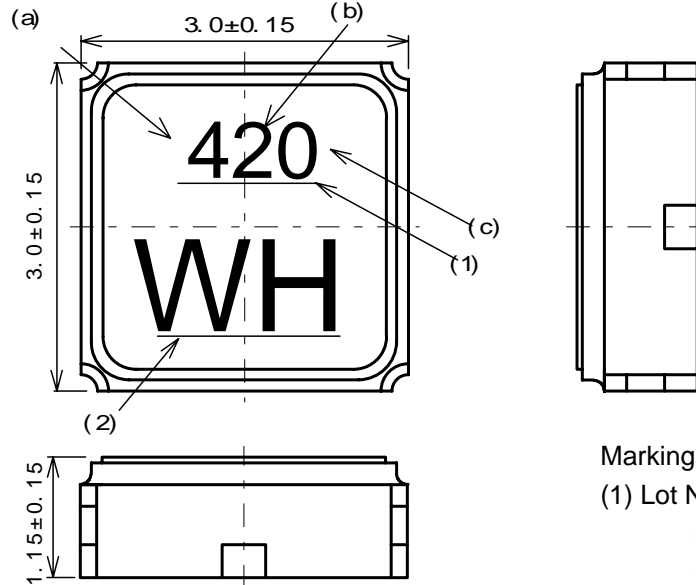

Fig.1 Measuring circuit



Marking

(1) Lot Number

(a) Year

(b) Month

\*Oct.--- X

Nov.--- Y

Dec.--- Z

(c) Date

1-9--- 0

10-19--- 1

20-31--- 2

(2) Part Number Mark

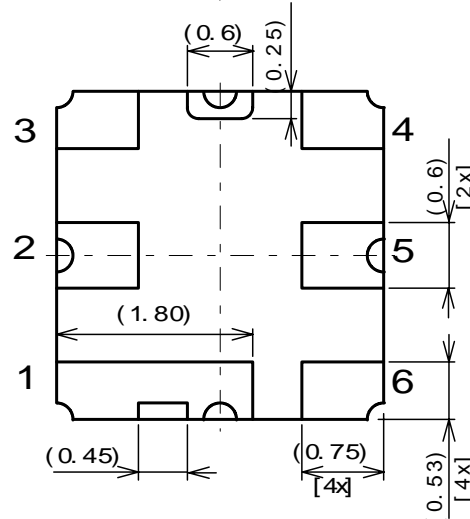

Fig.2 Package dimensions (in mm)

Pin no.	Connection
1	GND
2	IN/OUT
3	GND
4	GND
5	OUT/IN
6	GND

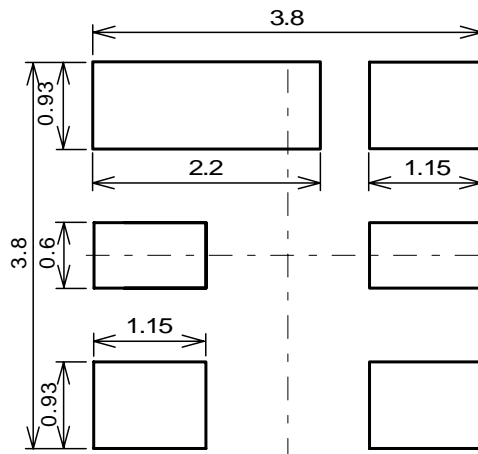

Fig.3 Desirable land area (in mm)

**Notice**

1. Use this component within operating temperature range. It might not be satisfied with electrical specification without operating temperature range. When it is used less than  $-40^{\circ}\text{C}$  or more than  $+85^{\circ}\text{C}$ , it might be a cause of degradation or destruction of the component. Even if it endures during a short time, it causes degradation of qualification.
2. When soldering iron is used, solder with the temperature at the tip of soldering iron:  $350^{\circ}\text{C}$  max., the time of soldering: 10 seconds max., the power of soldering iron: 30W max..
3. Notice that the allowed time of soldering with soldering iron is accumulated time, when soldering is repeated.
4. As rapid temperature change for cleaning after reflow soldering might be a cause of destruction clean this component after confirming that temperature of this component goes down to room temperature.
5. Confirm that there are not any influence for qualification to this component in mounting on PCB when this component is cleaned.
6. As it might be a cause of degradation or destruction to apply static electricity to this component, do not apply static electricity or excessive voltage while assembling and measuring. And do not transport this component with bare hand.
7. As it might be a cause of degradation or destruction to apply D.C. voltage between each terminal, apply D.C. voltage 7.5V max. in actual circuit.

**Note**

1. This specification specifies the quality of this component as a single unit. Make sure that this component is evaluated and confirmed against this specification when it is mounted to your products.
2. The information contained herein may be changed without prior notice. It is therefore advisable to contact New Japan Radio Company before proceeding with the design of equipment incorporating this product.
3. The products are designed to be used with ordinary electronic equipment (data and communications equipment, office equipment, audio-video equipment, measuring instruments, etc). New Japan Radio Company does not assume any liability for the case using the products with the application required high reliability or safety extremely (such as space equipment, sea-bottom equipment, medical equipment etc). When intending to use any our product please contact our sales representatives in advance.

### FREQUENCY CHARACTERISTICS

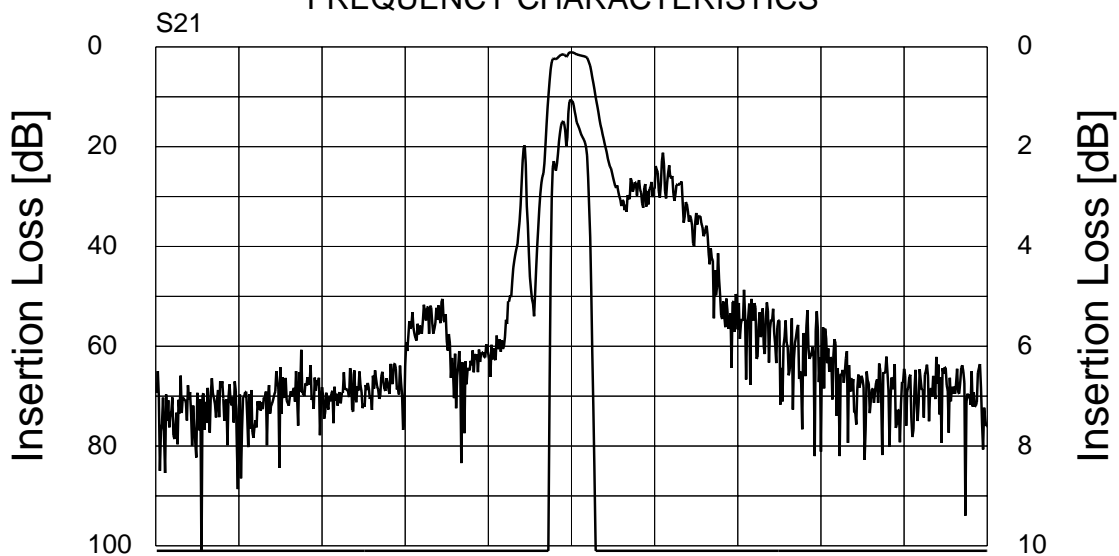

CH1 : center 314.35 span 100  
 CH2 : center 314.35 span 100

S11

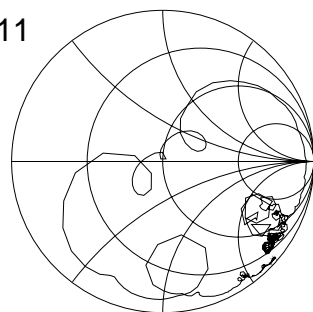

S22

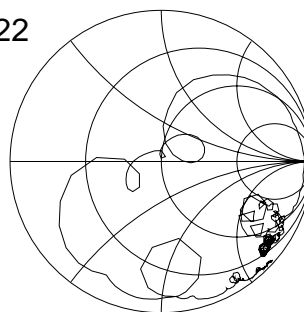

S11

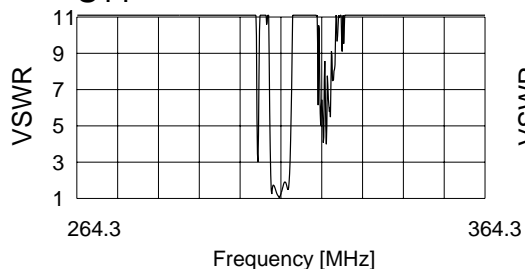

S22

