

1.1GHz Prescaler With Stand-By Mode

The MC12083 is a ÷2 prescaler for low power frequency division of a 1.1GHz high frequency input signal. On-chip output termination provides output current to drive a 2pF (typical) high impedance load. If additional drive is required for the prescaler output, an external resistor can be added parallel from the OUT Pin to GND to increase the output power. Care must be taken not to exceed the maximum allowable current through the output.

Stand-By mode is featured to reduce current drain to 250µA typical when the stand-by pin SB is switched LOW disabling the prescaler.

- 1.1GHz Toggle Frequency
- Supply Voltage 2.7V to 5.5V
- Low Power 4.5mA Typical at $V_{CC} = 2.7V$
- Operating Temperature -40 to +85°C
- On-Chip Termination

Pinout: 8-Lead Plastic (Top View)

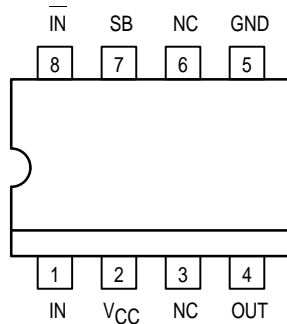

A LOW on the Stand-By Pin 7 disables the device.

MC12083

MECL PLL COMPONENTS

÷2
PRESCALER
WITH STAND-BY MODE

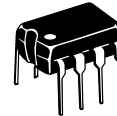

P SUFFIX
8-LEAD PLASTIC PACKAGE
CASE 626-05



D SUFFIX
8-LEAD PLASTIC SOIC PACKAGE
CASE 751-05

MAXIMUM RATINGS

Symbol	Parameter	Value	Unit
V_{CC}	Power Supply Voltage, Pin 2	-0.5 to +7.0	VDC
T_A	Operating Temperature Range	-40 to +85	°C
T_{stg}	Storage Temperature Range	-65 to +150	°C
I_O	Maximum Output Current, Pin 4	10.0	mA



ELECTRICAL CHARACTERISTICS ($V_{CC} = 2.7$ to $5.5V$; $T_A = -40$ to $+85^\circ C$)

Symbol	Parameter	Min	Typ	Max	Unit
f_t	Toggle Frequency (Sine Wave)	0.1	1.4	1.1	GHz
I_{CC}	Supply Current Output (Pin 2) $V_{CC} = 3.0V$ $V_{CC} = 5.5V$		4.4 4.8	6.5 6.5	mA
I_{SB}	Standby Current $V_{CC} = 3.0V$ $V_{CC} = 5.5V$		250 500	350 600	μA
V_{IH}	Standby Input HIGH (SB)	2.0		V_{CC}	V
V_{IL}	Standby Input LOW (SB)	GND		0.8	V
V_{OUT}	Output Voltage Swing (Note 1.) 2pF Load @ 500MHz Input 2pF Load @ 750MHz Input 2pF Load @ 1100MHz Input	700 600 400	800 700 450		mV _{PP}
V_{IN}	Input Voltage Sensitivity 100–250MHz 250–400MHz 400–1100MHz	400 200 100		1000 1000 1000	mV _{PP}

1. Assume 2pF load, $V_{CC} = 2.7V$, V_{IN} = minimum specification for each frequency band, $T_A = 85^\circ C$

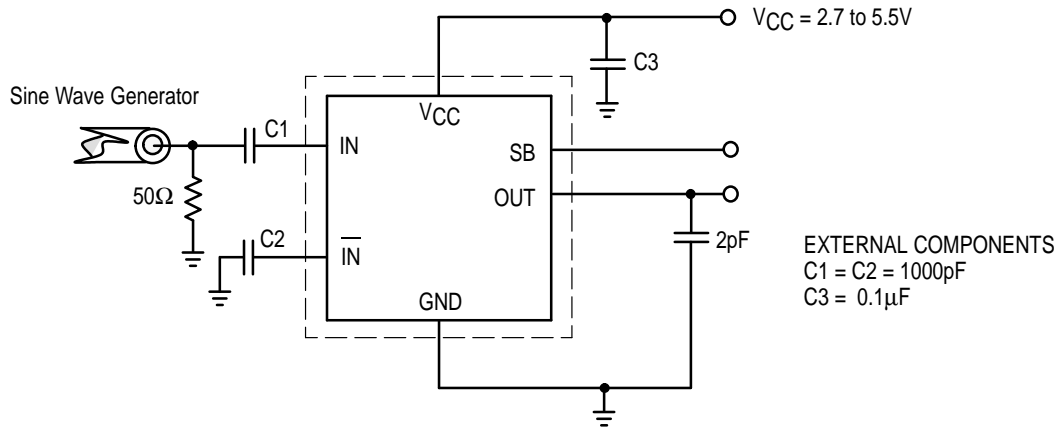

Figure 1. AC Test Circuit

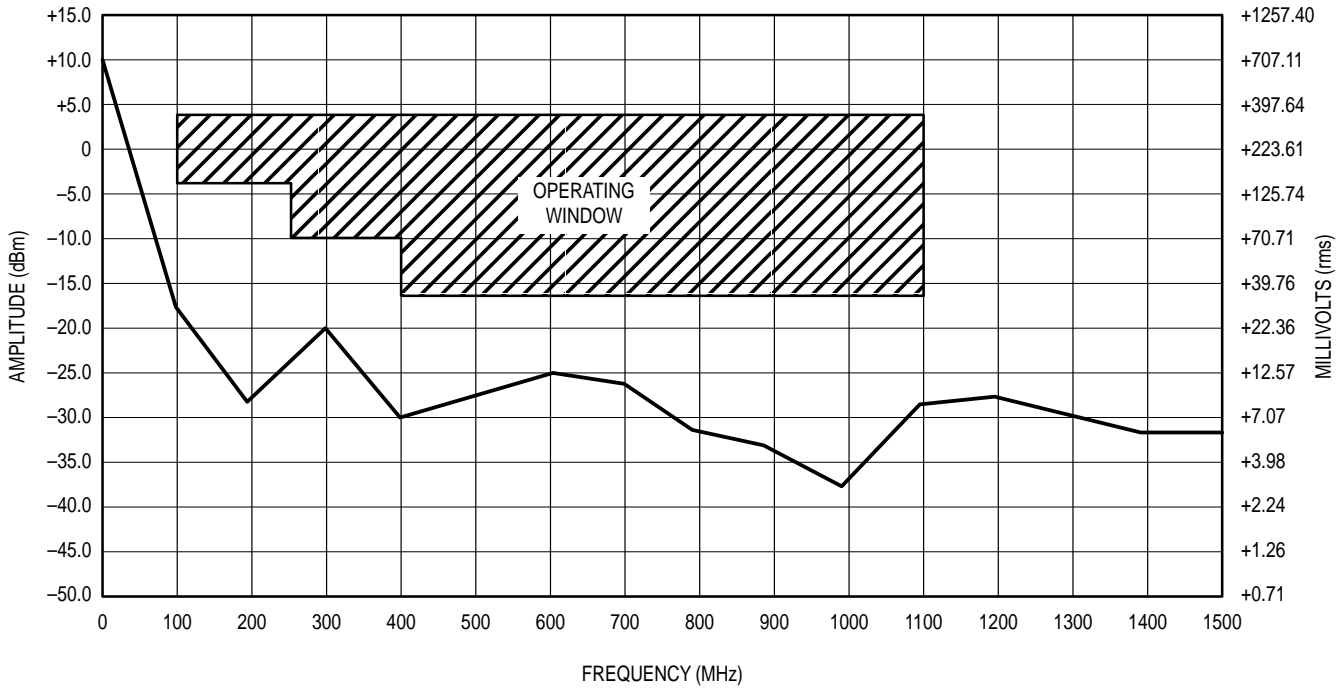

Figure 2. Input Signal Amplitude versus Input Frequency
 Divide Ratio = 2; VCC = 2.7V; TA = 25°C; Output Loaded With 2pF

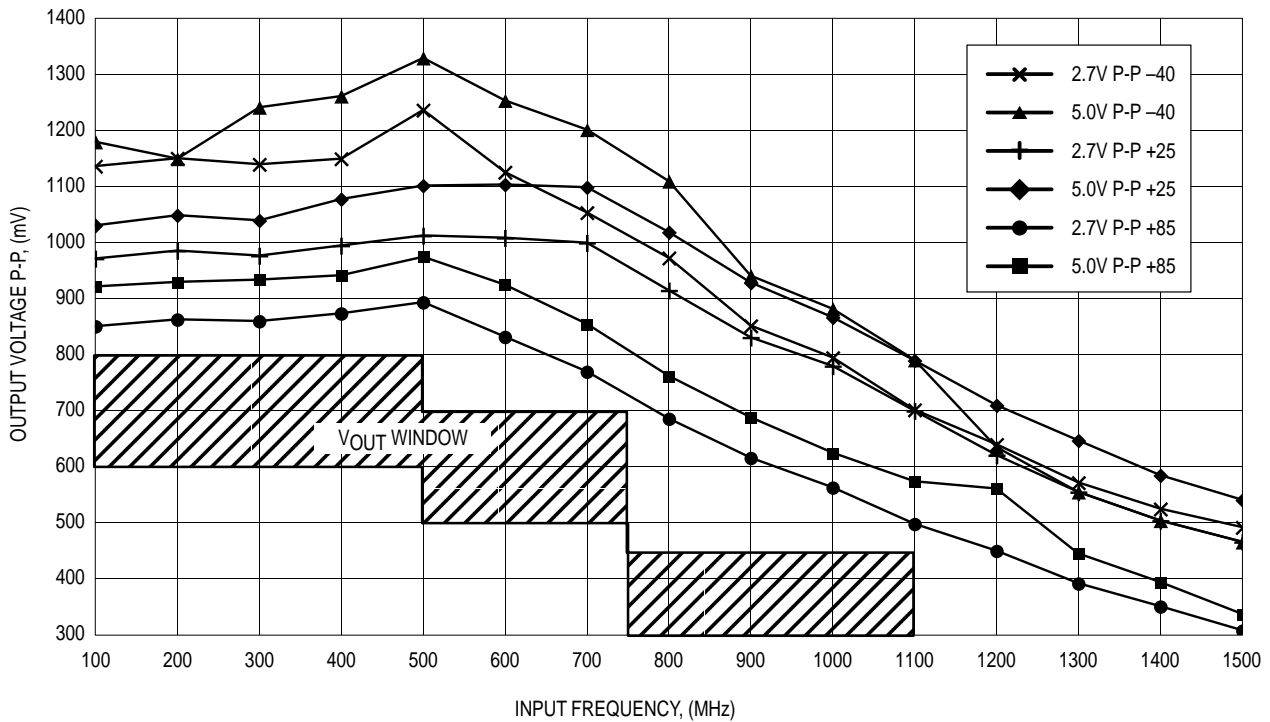
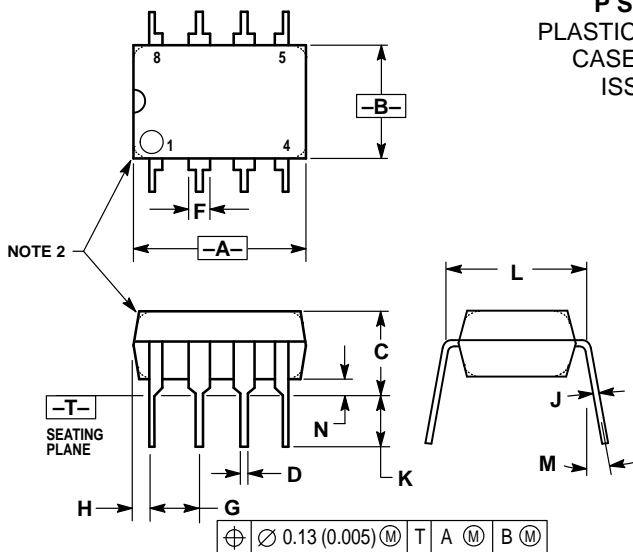

Figure 3. 12083 Output Peak-to-Peak at 2pF Load

OUTLINE DIMENSIONS

P SUFFIX
PLASTIC PACKAGE
CASE 626-05
ISSUE K



- NOTES:
1. DIMENSION L TO CENTER OF LEAD WHEN FORMED PARALLEL.
 2. PACKAGE CONTOUR OPTIONAL (ROUND OR SQUARE CORNERS).
 3. DIMENSIONING AND TOLERANCING PER ANSI Y14.5M, 1982.

DIM	MILLIMETERS		INCHES	
	MIN	MAX	MIN	MAX
A	9.40	10.16	0.370	0.400
B	6.10	6.60	0.240	0.260
C	3.94	4.45	0.155	0.175
D	0.38	0.51	0.015	0.020
F	1.02	1.78	0.040	0.070
G	2.54 BSC		0.100 BSC	
H	0.76	1.27	0.030	0.050
J	0.20	0.30	0.008	0.012
K	2.92	3.43	0.115	0.135
L	7.62 BSC		0.300 BSC	
M	10°		10°	
N	0.76	1.01	0.030	0.040

D SUFFIX
PLASTIC SOIC PACKAGE
CASE 751-05
ISSUE R

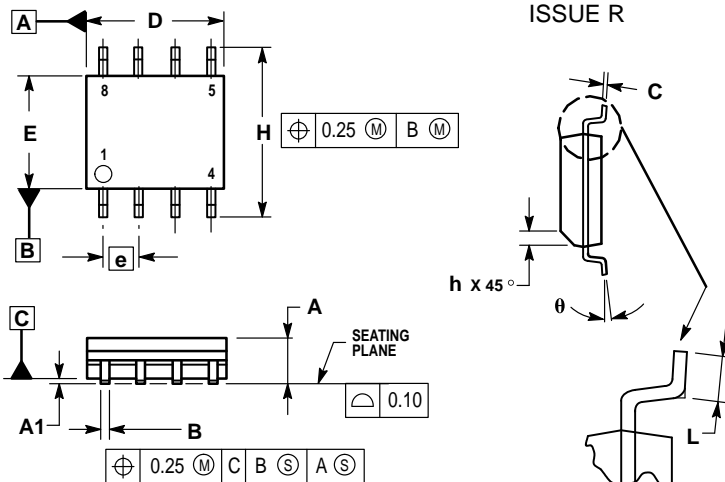

- NOTES:
1. DIMENSIONING AND TOLERANCING PER ASME Y14.5M, 1994.
 2. DIMENSIONS ARE IN MILLIMETERS.
 3. DIMENSION D AND E DO NOT INCLUDE MOLD PROTRUSION.
 4. MAXIMUM MOLD PROTRUSION 0.15 PER SIDE.
 5. DIMENSION B DOES NOT INCLUDE MOLD PROTRUSION. ALLOWABLE DAMBAR PROTRUSION SHALL BE 0.127 TOTAL IN EXCESS OF THE B DIMENSION AT MAXIMUM MATERIAL CONDITION.

DIM	MILLIMETERS	
	MIN	MAX
A	1.35	1.75
A1	0.10	0.25
B	0.35	0.49
C	0.18	0.25
D	4.80	5.00
E	3.80	4.00
e	1.27 BSC	
H	5.80	6.20
h	0.25	0.50
L	0.40	1.25
θ	0° 7°	

Motorola reserves the right to make changes without further notice to any products herein. Motorola makes no warranty, representation or guarantee regarding the suitability of its products for any particular purpose, nor does Motorola assume any liability arising out of the application or use of any product or circuit, and specifically disclaims any and all liability, including without limitation consequential or incidental damages. "Typical" parameters which may be provided in Motorola data sheets and/or specifications can and do vary in different applications and actual performance may vary over time. All operating parameters, including "Typicals" must be validated for each customer application by customer's technical experts. Motorola does not convey any license under its patent rights nor the rights of others. Motorola products are not designed, intended, or authorized for use as components in systems intended for surgical implant into the body, or other applications intended to support or sustain life, or for any other application in which the failure of the Motorola product could create a situation where personal injury or death may occur. Should Buyer purchase or use Motorola products for any such unintended or unauthorized application, Buyer shall indemnify and hold Motorola and its officers, employees, subsidiaries, affiliates, and distributors harmless against all claims, costs, damages, and expenses, and reasonable attorney fees arising out of, directly or indirectly, any claim of personal injury or death associated with such unintended or unauthorized use, even if such claim alleges that Motorola was negligent regarding the design or manufacture of the part. Motorola and $\text{\textcircled{M}}$ are registered trademarks of Motorola, Inc. Motorola, Inc. is an Equal Opportunity/Affirmative Action Employer.

How to reach us:

USA/EUROPE/Locations Not Listed: Motorola Literature Distribution; P.O. Box 5405; Denver, Colorado 80217. 303-675-2140 or 1-800-441-2447

JAPAN: Nippon Motorola Ltd.; Tatsumi-SPD-JLDC, 6F Seibu-Butsuryu-Center, 3-14-2 Tatsumi Koto-Ku, Tokyo 135, Japan. 81-3-3521-8315

Mfax™: RMFAX0@email.sps.mot.com – TOUCHTONE 602-244-6609
INTERNET: http://Design-NET.com

ASIA/PACIFIC: Motorola Semiconductors H.K. Ltd.; 8B Tai Ping Industrial Park, 51 Ting Kok Road, Tai Po, N.T., Hong Kong. 852-26629298