

PNP Transistors

2SB1181

■ Features

- High breakdown voltage and high current.
- Low collector-emitter saturation voltage $V_{CE(sat)}$
- Good h_{FE} linearity.
- Complementary to 2SD1733

■ Absolute Maximum Ratings $T_a = 25^\circ\text{C}$

Parameter	Symbol	Rating	Unit	
Collector - Base Voltage	V_{CBO}	-80	V	
Collector - Emitter Voltage	V_{CEO}	-80		
Emitter - Base Voltage	V_{EBO}	-5		
Collector Current - Continuous	I_C	-1	A	
Collector current -Pulse	I_{CP}	-2		
Collector Power Dissipation	P_C	$T_c=25^\circ\text{C}$	10	W
		$T_a = 25^\circ\text{C}$	1	
Junction Temperature	T_J	150	$^\circ\text{C}$	
Storage Temperature range	T_{stg}	-55 to 150		

■ Electrical Characteristics $T_a = 25^\circ\text{C}$

Parameter	Symbol	Test Conditions	Min	Typ	Max	Unit
Collector- base breakdown voltage	V_{CBO}	$I_C = -100 \mu\text{A}$, $I_E = 0$	-80			V
Collector- emitter breakdown voltage	V_{CEO}	$I_C = -1 \text{ mA}$, $I_B = 0$	-80			
Emitter - base breakdown voltage	V_{EBO}	$I_E = -100 \mu\text{A}$, $I_C = 0$	-5			
Collector-base cut-off current	I_{CBO}	$V_{CB} = -60\text{V}$, $I_E = 0$			-1	μA
Emitter cut-off current	I_{EBO}	$V_{EB} = -4\text{V}$, $I_C = 0$			-1	
Collector-emitter saturation voltage	$V_{CE(sat)}$	$I_C = -500 \text{ mA}$, $I_B = -50 \text{ mA}$			-0.4	V
Base - emitter saturation voltage	$V_{BE(sat)}$	$I_C = -500 \text{ mA}$, $I_B = -50 \text{ mA}$			-1.2	
DC current gain	h_{FE}	$V_{CE} = -3\text{V}$, $I_C = -100 \text{ mA}$	120		390	
Collector output capacitance	C_{ob}	$V_{CB} = -10\text{V}$, $I_E = 0$, $f = 1\text{MHz}$		25		pF
Transition frequency	f_T	$V_{CE} = -10\text{V}$, $I_E = 50 \text{ mA}$, $f = 100\text{MHz}$		100		MHz

■ Classification of h_{fe}

Type	2SB1181-Q	2SB1181-R
Range	120-270	180-390

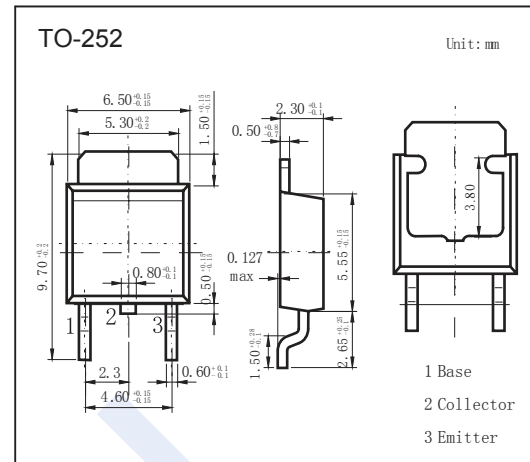

PNP Transistors 2SB1181

■ Typical Characteristics

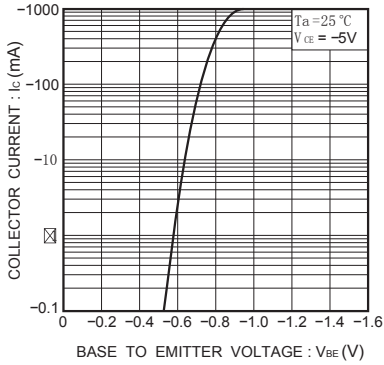

Fig.1 Grounded emitter propagation characteristics

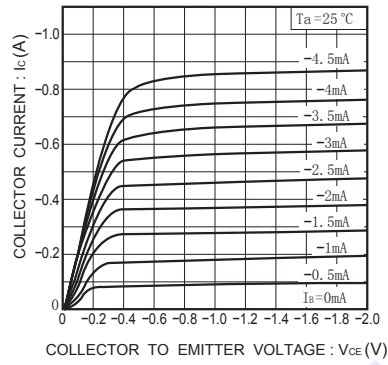

Fig.2 Grounded emitter output characteristics

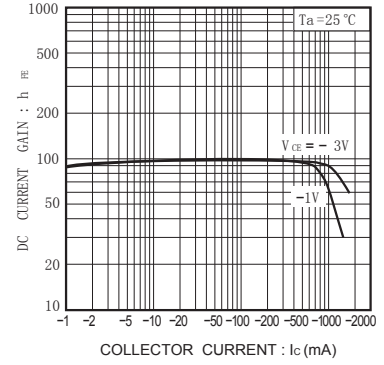

Fig.3 DC current gain vs. collector current

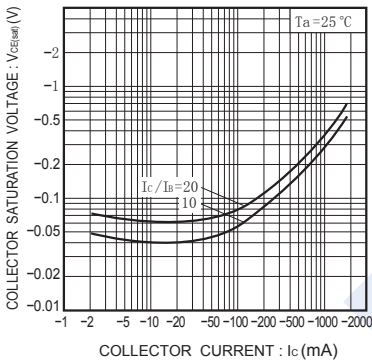

Fig.4 Collector-emitter saturation voltage vs. collector current

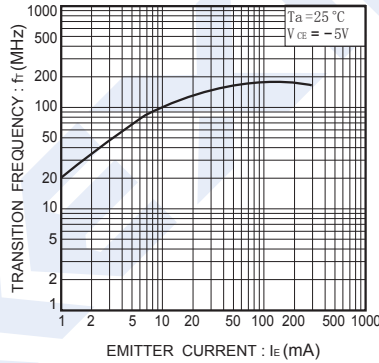

Fig.5 Gain bandwidth product vs. emitter current

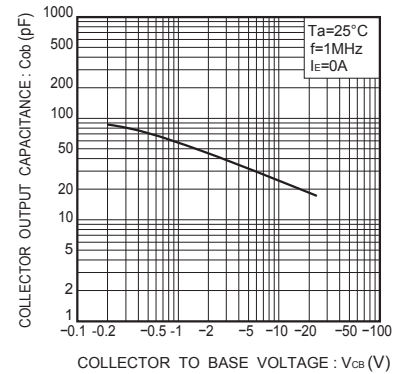

Fig.6 Collector output capacitance vs. collector-base voltage