

KEMET Part Number: LDEIC2220KA0N00
(DEIC2220KA0N00)

Film, Metallized PEN Stacked, Commercial Grade, LDE, 0.022 uF, 10%, 250 V, 120 V, 125C, 1812, 2.2mm

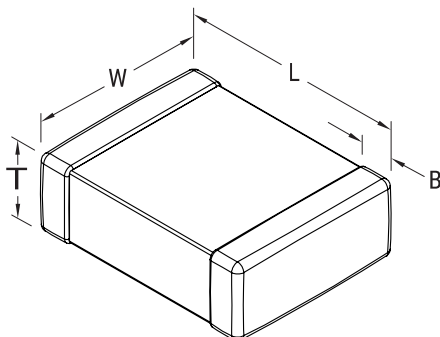

Dimensions	
Chip Size	1812
L	4.7mm +0.3/-0.2mm
W	3.3mm +/-0.3mm
T	2.2mm MAX
B	0.5mm +0.5/-0.3mm

Packaging Specifications	
Packaging:	T&R
Packaging Quantity:	3000

General Information	
Dielectric:	Metallized PEN Stacked
Style:	SMD Chip
Series:	LDE
RoHS:	Yes
Approvals:	AEC-Q200
AEC-Q200:	Yes

Specifications	
Capacitance:	0.022 uF
Capacitance Tolerance:	10%
Voltage DC:	250 VDC
Voltage AC:	120 V
Temperature Range:	-55/+125C
Rated Temperature:	125C
Dissipation Factor:	0.8% 1kHz
Insulation Resistance:	1 GOhms
Max dVdt:	100 V