

DS28E36 Evaluation System

Evaluates: DS28E36 and DS2476

General Description

The DS28E36 evaluation system (EV system) provides the hardware and software necessary to evaluate the DS28E36 and DS2476. The EV system consists of five DS28E36/DS2476 devices in a 6-pin TDFN package, a DS9121AQ+ evaluation TDFN socket board, and a DS9481P-300# USB-to-I²C/1-Wire[®] adapter. The evaluation software runs on Windows[®] 10, Windows 8, and Windows 7 operating systems (64- and 32-bit versions). The EV system provides a handy user interface to exercise the features of the DS28E36 and DS2476.

EV System Contents

QTY	DESCRIPTION
5	Includes five DS28E36Q+ DeepCover Secure Authenticators (6-pin TDFN)
5	DS2476Q+ DeepCover Secure Coprocessor (6-pin TDFN)
1	DS9121AQ+ socket board (6-pin TDFN)
1	DS9481P-300# USB-to-I ² C/1-Wire Adapter
1	USB Type-A to USB Mini Type-B cable

Ordering Information appears at end of data sheet.

Features

- Demonstrates the Features of the DS28E36 DeepCover[®] Secure Authenticator
- Demonstrates the Features of the DS2476 DeepCover Secure Coprocessor
- I²C and 1-Wire Communication is Logged to Aid Firmware Designers Understanding of the DS2476 and DS28E36
- I²C/1W-USB Adapter Creates a Virtual COM Port on Any PC
- Fully Compliant with USB Specification v2.0
- Software Runs on Windows 10, Windows 8, and Windows 7 for Both 64-Bit and 32-Bit Versions
- 3.3V ±3% 1-Wire Operating Voltage
- Convenient On-Board Test Points and TDFN Socket
- Evaluation Software Available by Request
- Proven PCB Layout
- Fully Assembled and Tested

DS28E36 EV System

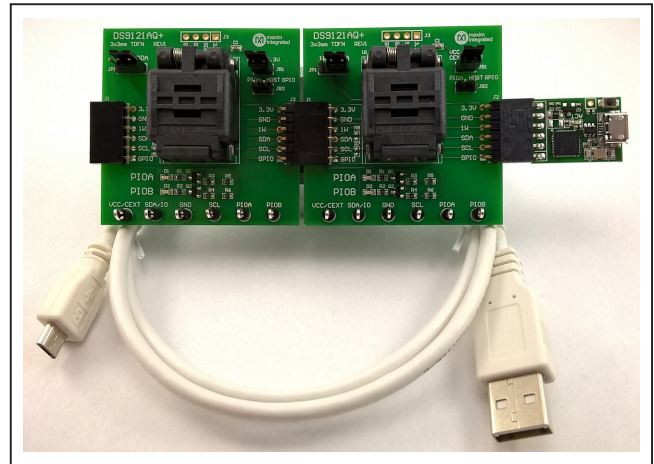

Figure 1. DS28E36EV with USB Cable

1-Wire and DeepCover are registered trademarks of Maxim Integrated Products, Inc.

Windows is a registered trademark and registered service mark of Microsoft Corporation.

Quick Start

This section is intended to give the DS28E36 evaluator a list of recommended equipment and instructions on how to set up a Windows-based computer for the evaluation software.

Recommended Equipment

- DS28E36 EV system USB-to-I²C adapter with DS2476 secure coprocessor (included)
- DS9120AQ+ TDFN socket board (included)
- Five DS28E36Q+ (included, respectively)
- Five DS2476Q+ (included)
- USB Type A to Micro-USB Type B cable (included)
- Computer with a Windows 10, Windows 8, or Windows 7 operating system (64- or 32-bit) and a spare USB 2.0 or higher port
- Download [DS28E36 EV kit software \(light version\)](#) or request full [DS28E36 EV kit developer software](#).

Note: In the following sections, software-related items are identified by **bolding**. Text in bold refers to items directly from the EV system software. Text in **bold and underlined** refers to items from the Windows operating system.

Hardware Setup and Driver Installation Quick Start Procedure

The EV system is fully assembled and tested. The following steps were performed on a Windows 7 PC to set up the DS28E36EVKIT hardware/software:

- 1) Obtain and unpack the zip of **DS28E36_EVKIT_REV_1_6_Light_version.zip** or newer version.
- 2) In a file viewer, double click on **DS28E36_Installer.msi** to begin the installation ([Figure 2](#)).
- 3) The Setup Wizard opens. Click on **Next**, as shown in [Figure 3](#).
- 4) Read and check the box for the license agreement and click on **Next** again to install to the selected folder ([Figure 4](#)).

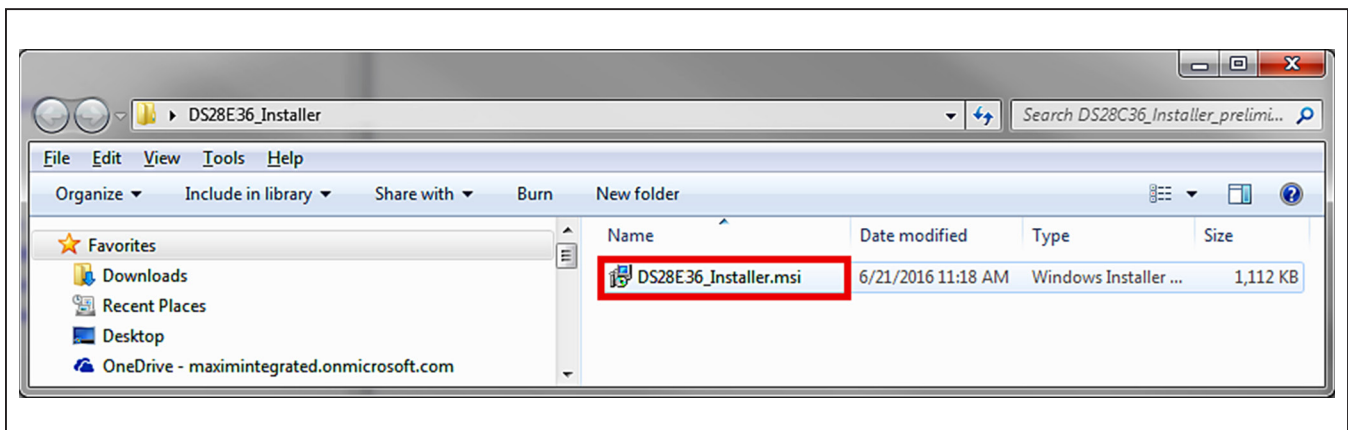

Figure 2. File Viewer

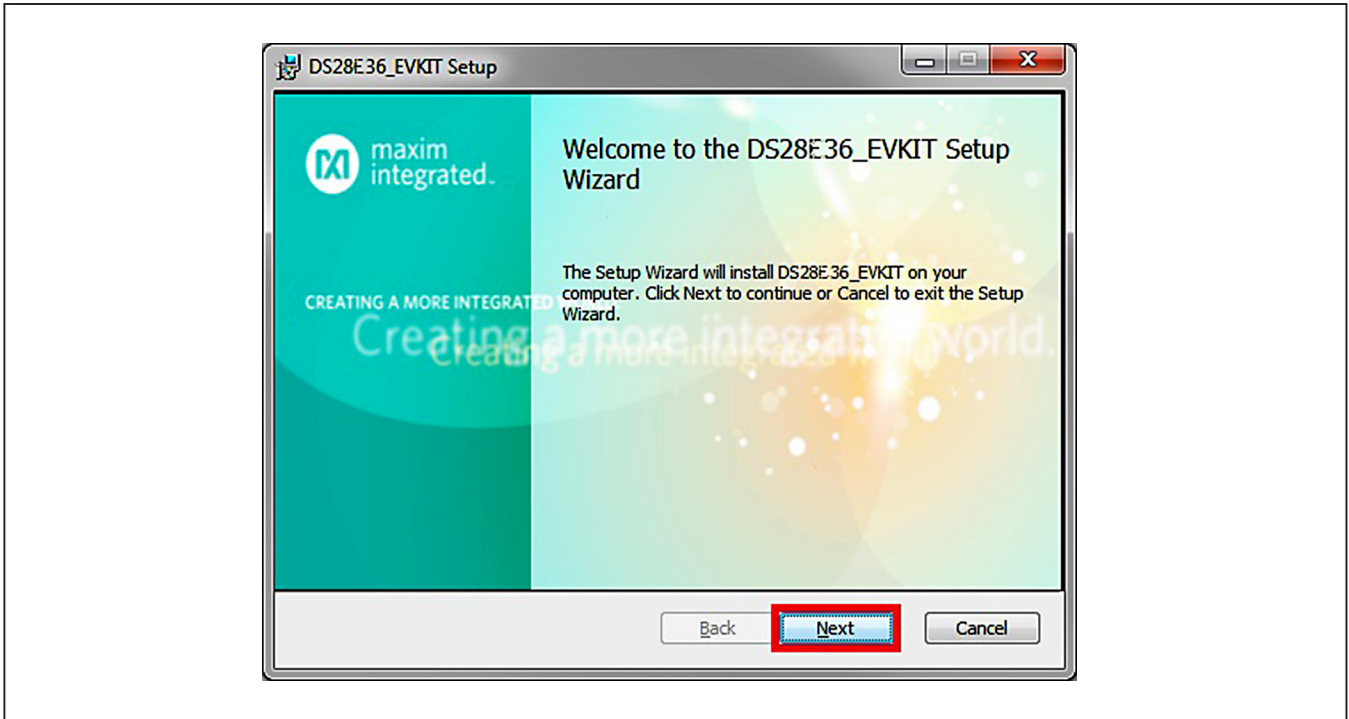

Figure 3. DS28E36 Setup Wizard

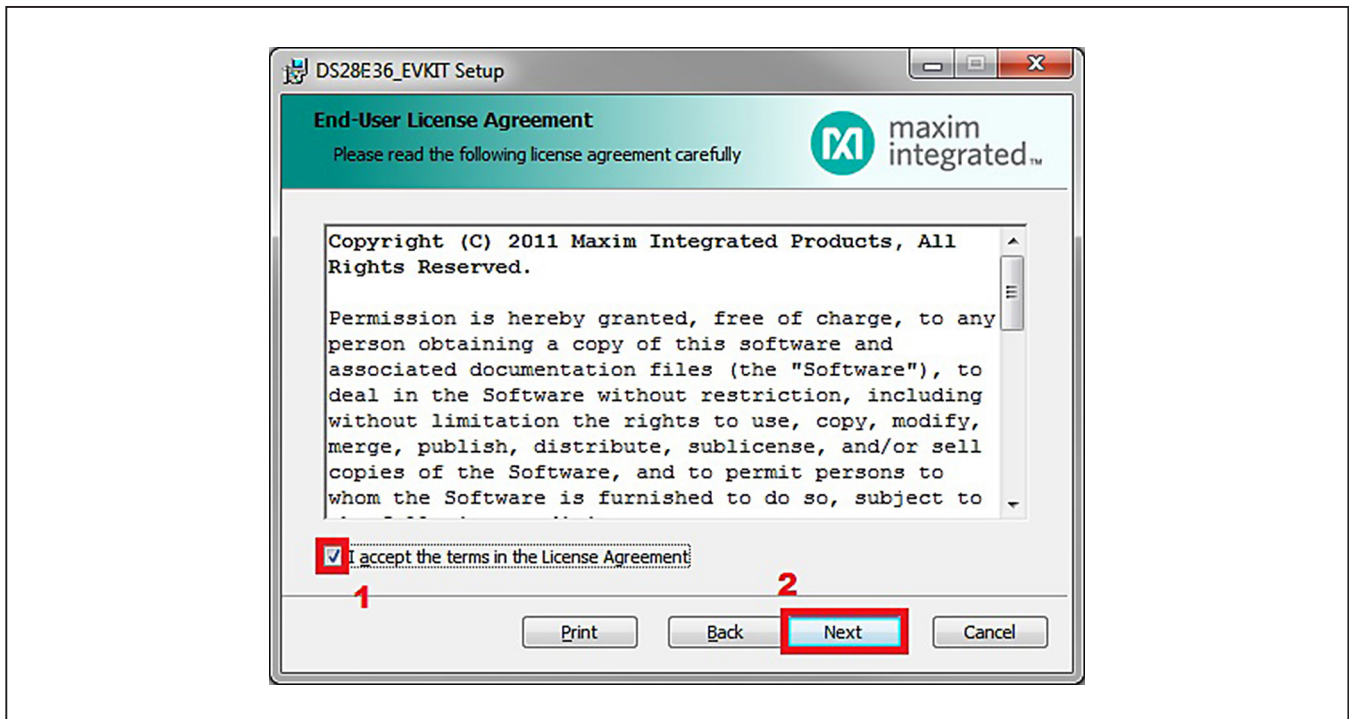

Figure 4. License Agreement Setup Wizard

- 5) Click the **Next** button to install to the default folder (Figure 5).
- 6) Unplug all Maxim adapters and click the **Install** button (Figure 6).
- 7) When the **Windows Security** window appears, click the **Install** button (Figure 7).
- 8) Click the **Finish** button to exit the Setup Wizard (Figure 8).

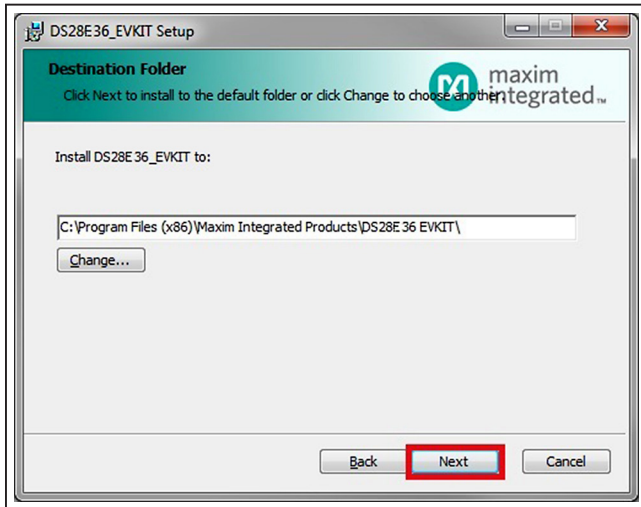

Figure 5. Install Folder Location

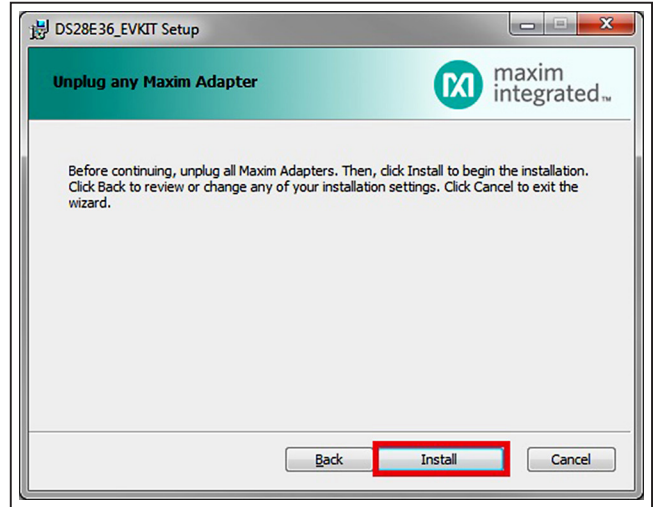

Figure 6. Installation

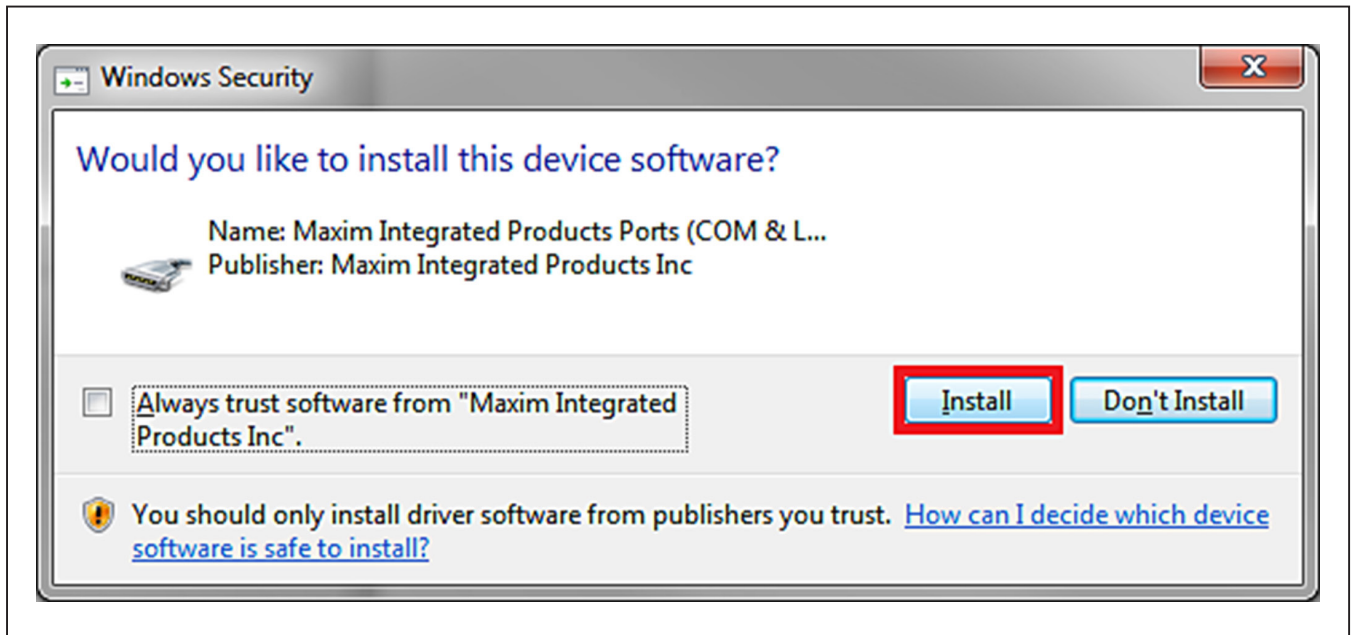

Figure 7. Windows Security Window

DS28E36 Evaluation System

Evaluates: DS28E36 and DS2476

- 9) Plug in the DS9481P-300# to the PC with both DS9120AQ+ socket boards by doing the following:
 - a) Open the first burn-in socket and insert a DS2476Q+ into one of the cavities, as shown in [Figure 9](#). **Note:** The plus (+) on the package must be on the opposite side of the marker in the socket.
 - b) Open the second burn-in socket and insert a DS28E36Q+ into one of the cavities, following the same orientation shown in [Figure 9](#).
 - c) Close both burn-in sockets.
 - d) Connect the first DS9121AQ J2, 6-pin female socket into the DS9481P-300#, 6-pin male plug, as shown in [Figure 10](#).
 - e) Connect the second DS9121AQ J2, 6-pin female socket into the 1st DS9121AQ J1, 6-pin male plug. ([Figure 10](#)).

- f) For the first socket board with DS2476, configure the jumpers JP1 to use SDA and JB1 to use 3.3V. With the DS28E36, configure the jumpers to JP1 to use 1W and do not populate JB1 ([Figure 10](#)).
- g) Plug the DS28E36 EV kit into the PC using a USB Type-A to Micro-USB Type-B cable.

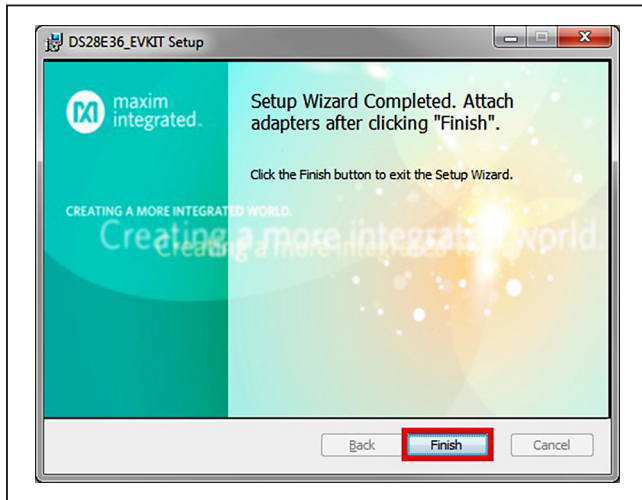

Figure 8. Finish Setup Wizard

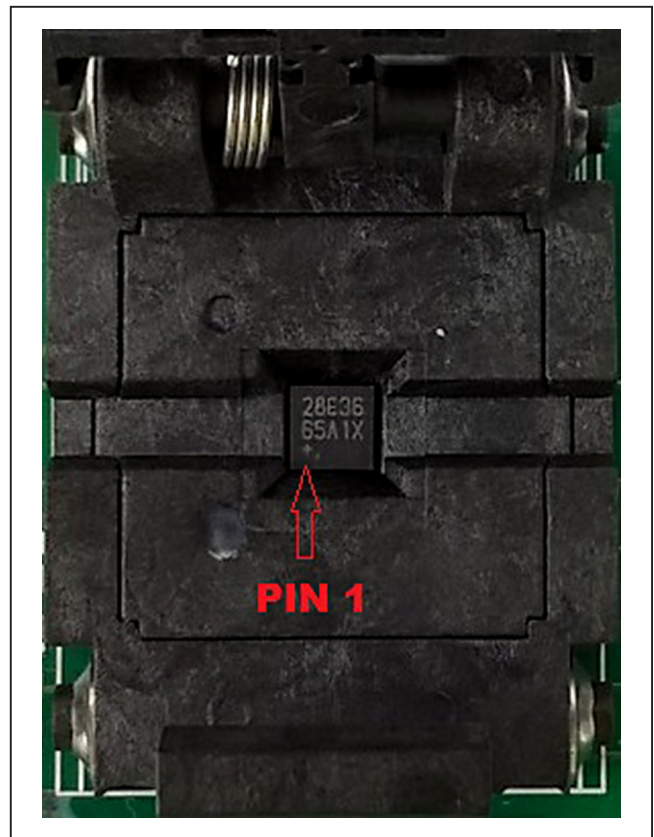

Figure 9. Orientation of the DS28E36 and DS2476 in the Burn-In Socket

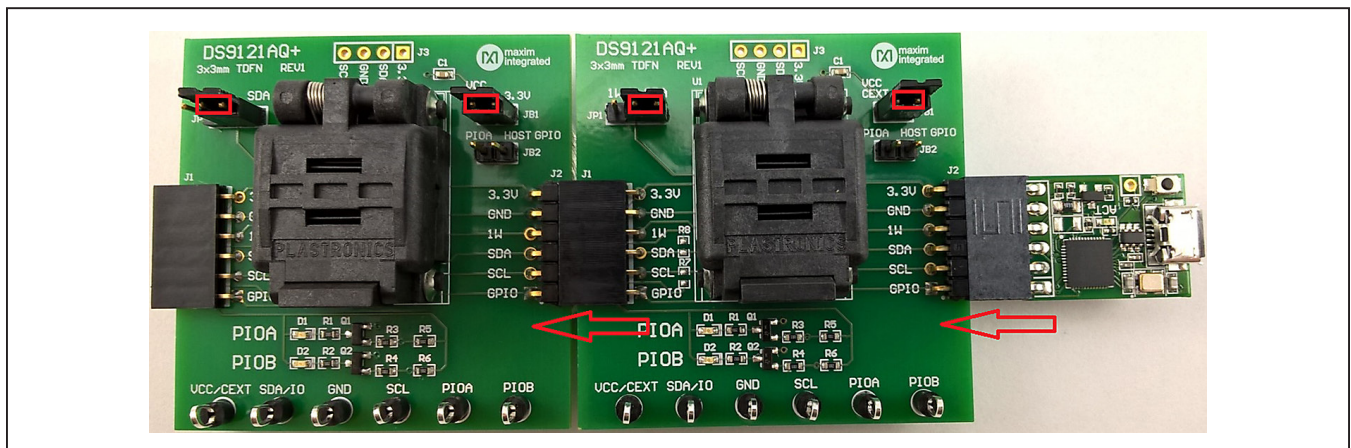

Figure 10. DS9481QA-300 and DS9121AQ

- 10) The device driver now automatically installs and a pop-up window appears when complete (Figure 11).
- 11) Open the **DS28E36 EVKIT** from the start menu → **All Programs** → **Maxim Integrated** → **DS28E36 EVKIT (Light Version)**.

- 12) The DS28E36 EVKIT program opens automatically (Figure 13), finding the COM port and the DS28E36/DS2476.

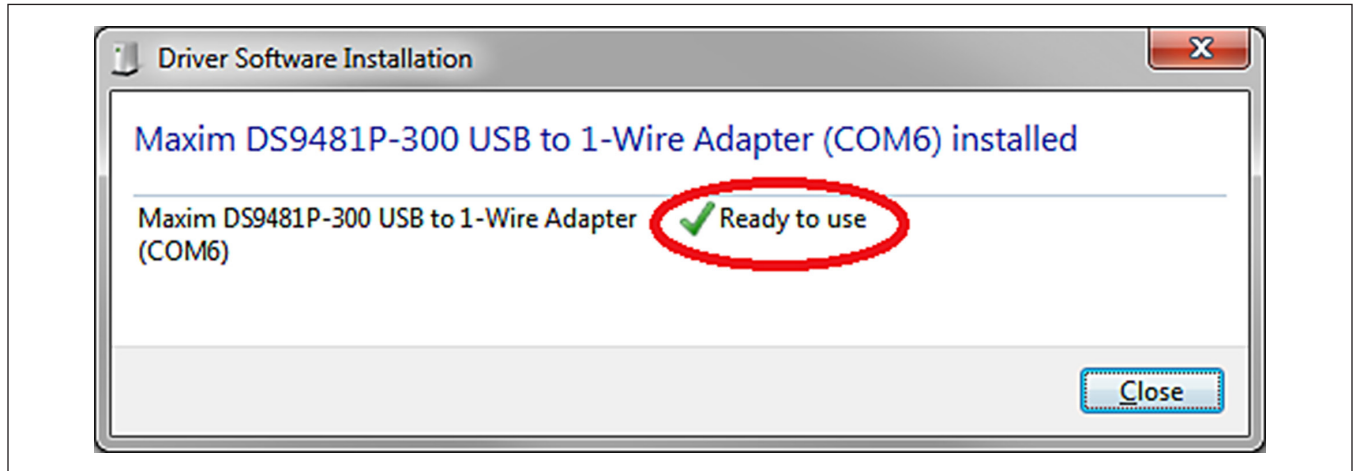

Figure 11. Driver Software Installation Notice

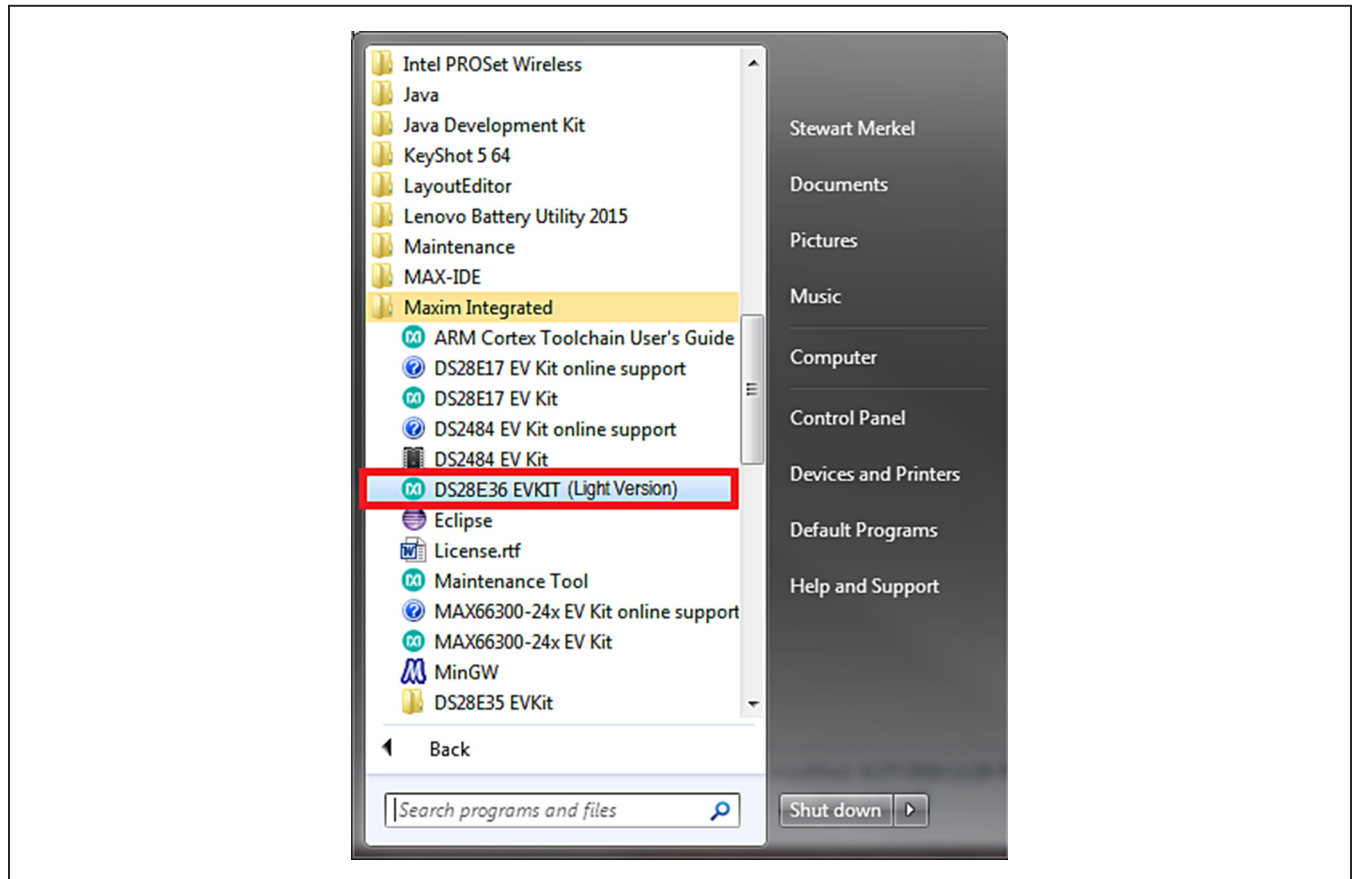

Figure 12. Open DS28E36 EVKIT Program

Detailed Description of Software

The DS28E36 evaluation program user interface (Figure 13) has four tabs, **General Commands**, **SHA2 Commands**, **ECDSA Commands**, and **Other Coprocessor Commands**. The **Setup** section is used to make the device selections that apply to the **General Commands**, **SHA2 Commands**, **ECDSA Commands**, and **Other Coprocessor Commands** tabs. Here is a summary of the function for each tab of the full developer software:

- General Commands is used as the main tool to evaluate the DS28E36/DS2476 general functions to write or read from the user memory pages, crypto-related memory pages, decrement counter, RNG, and protection registers.

- SHA2 Commands is used to evaluate the DS28E36/DS2476 symmetric (SHA-256) security function commands.
- ECDSA Commands is used to evaluate the DS28E36/DS2476 integrated asymmetric (ECC-P256) security function commands.
- Other Coprocessor Commands is used to evaluate the DS2476 coprocessor that computes any required HMACs or ECDSA signatures with its additional command set to do any operations on the DS28E36. Note: Grayed out when DS28E36 is selected.

All tabs include a communications **Log** area consisting of an I²C Log or 1-Wire Log output.

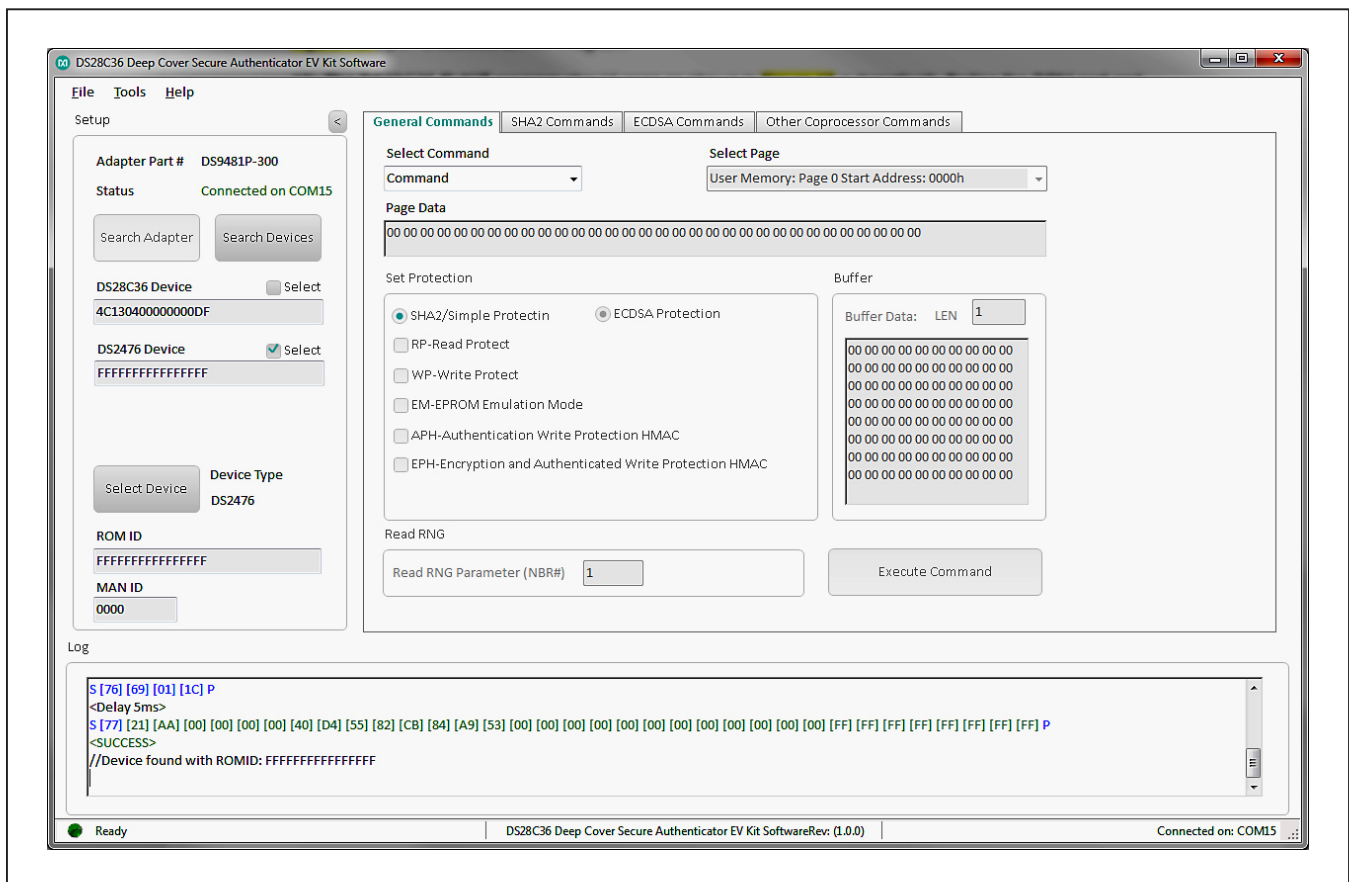

Figure 13. DS28E36 EVKIT Developer Software (Note: The light version is similar, but includes fewer features)

Ordering Information

PART	TYPE
DS28E36EVKIT#	EV System

#Denotes RoHS compliant.

DS9481P-300 Bill of Materials

Designator	Quantity	Description	Manufacturer	Part Number
C1, C2, C4, C7, C9, C11, C12	7	1uF Ceramic Capacitor (0402)	TDK Corporation	C1005X5R0J105M050BB
C3, C8, C13	3	0.1uF Ceramic Capacitor (0402)	TDK Corporation	C1005X5R0J104K050BA
C5, C6	2	10pF Ceramic Capacitor (0603)	TDK Corporation	C1608C0G1H100D080AA
C10	1	10pF Ceramic Capacitor (0402)	MURATA	GRM1555C1H100J
CN1	1	USB Micro B Connector	FCI	10103594-0001LF
D1	1	Orange LED (0603)	Panasonic	LNJ826W83RA
FB1, FB2	2	Ferrite (0603)	Murata Electronics North	BLM18KG221SN1D
J1	1	PMOD Receptacle	Samtec	SSW-106-02-T-S-RA
Q1	1	N-Channel MOSFET (SOT-23)	Diodes Inc.	2N7002-7
Q2	1	P-Channel MOSFET (SOT-23)	International Rectifier	PMV65XP,215
R1	1	10Ω Resistor (0603)	Vishay Dale	CRCW060310R0JNEA
R2	1	1.5kΩ Resistor (0402)	Vishay Dale	CRCW04021K50JNED
R3, R6, R7	3	100kΩ 1% Resistor (0402)	Vishay Dale	CRCW0402100KFKED
R4	1	32.4kΩ 1% Resistor (0402)	Vishay Dale	CRCW040232K4FKED
R5	1	4.7kΩ Resistor (0402)	Panasonic	ERJ-2GEJ472X
R8	1	1kΩ Resistor (0402)	Vishay Dale	CRCW04021K00JNED
R9	1	2.2kΩ Resistor (0402)	Panasonic	ERJ-2GEJ222X
R10	1	499Ω Resistor (0402)	Vishay Dale	CRCW0402499RFKED
R11	1	4.99Ω 1% 1/8W Resistor (0805)	Vishay Dale	CRCW08054R99FKEA
R12	1	680Ω Resistor (0402)	Panasonic	ERJ-2GEJ681X
R13, R14	2	1.74kΩ Resistor (0402)	Panasonic Electronic Co	ERJ-2RKF1741X
RT1	1	PTC Fuse (1206)	Bourns Inc.	MF-NSMF012-2
S1	1	Tactile Switch	Omron Electronics Inc	B3U-1000P
U1	1	Security Token Microcontroller with RTC and USB	Maxim Integrated	MAXQ1010-A01+
U2	1	High PSRR, Low-Dropout, 150mA Linear Regulator	Maxim Integrated	MAX8891EXK33+
U3	1	Dual High-Speed Differential ESD-Protection IC	Maxim Integrated	MAX3207EAUT+
U4	1	40ns Single-Supply Comparator	Maxim Integrated	MAX9140AAXK+
U5	1	4 Channel +/- 30kv ESD Protector	Maxim Integrated	MAX13204EALT+
X1	1	12MHz Crystal	EPSON	FA-238V 12.0000MB-K3
X2	1	Do Not Populate (3.20x1.50mm)		

DS9481P-300 Schematics

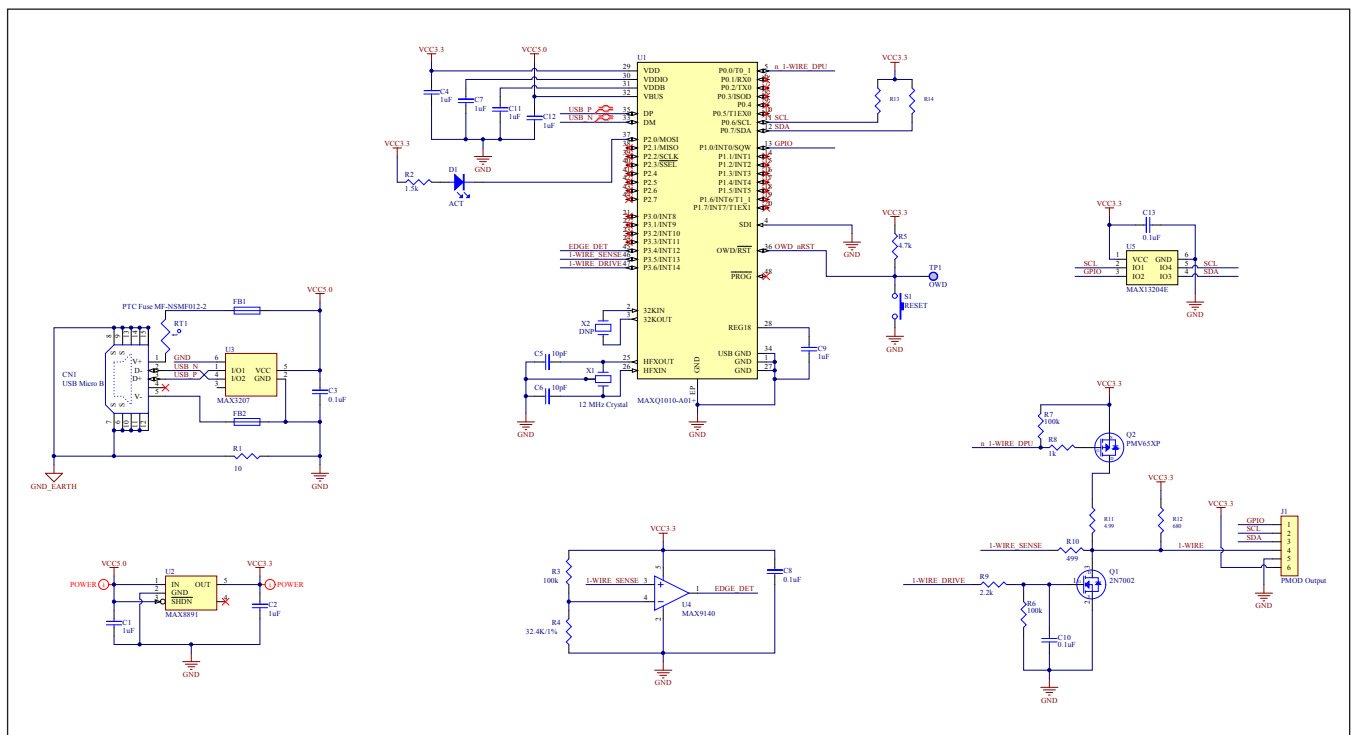

DS9481P-300 PCB Layout

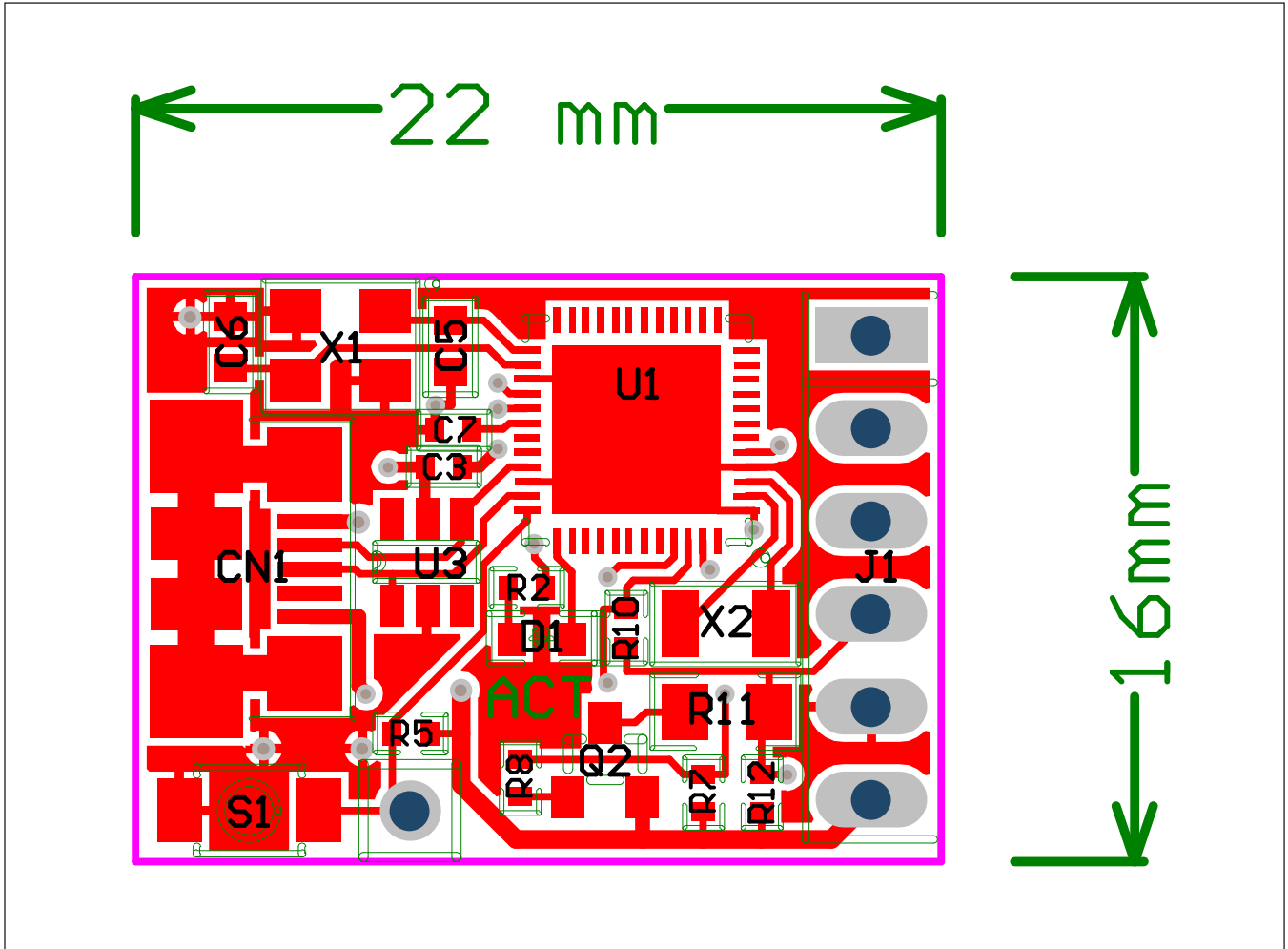

DS9121AQ Bill of Materials

Designator	Quantity	Description	Manufacture Name	Part Number
J3	1	4 Pin 100mil Female Connector	Samtec	SSQ-104-02-T-S-RA
R3, R4	2	RES 3.3K OHM 1/10W 1% 0603 SMD	Panasonic Electronic Components	ERJ-3EKF3301V
R1, R2, R5, R6	4	RES SMD 1K OHM 1% 1/10W 0603, RES SMD 10K OHM 1% 1/10W 0603	Panasonic Electronic Components	ERJ-3EKF1002V
R7, R8	2	RES SMD 10K OHM 1% 1/10W 0603	Panasonic Electronic Components	ERJ-3EKF1002V
C1	1	MOSFET N-CH 50V 200MA SOT-23	Kemet	C0603C104K8RACTU
Q1, Q2	2	MOSFET N-CH 50V 200MA SOT-23	ON SEMICONDUCTOR	BSS138LT1G
D1, D2	2	LED INGAN GREEN CLEAR 0603 SMD	Dialight	598-8081-107F
J1	1	CONN HEADER FEMALE 6POS .1" GOLD	TE Connectivity	9-146285-0
J2	1	CONN HEADER FEMALE 6POS .1" GOLD	TE Connectivity	9-146285-0
JP1	1	HDR, BRKWAY, .100 3POS VERT, 0.318"	Tyco Electronics	9-146276-0
U1	1	TDFN, 3MM, x2, CLAMHELL, BURNIN	PLASTRONICS	06QN10T23030
JB1, JB2	2	JUMPER BLOCK, .100 2POS VERT, 0.318"	Tyco Electronics	22-28-4363
Pack Out	3	SHUNT+, LP W/HANDLE 2 POS 30AU	Tyco Electronics	881545-2

DS9121AQ Schematics

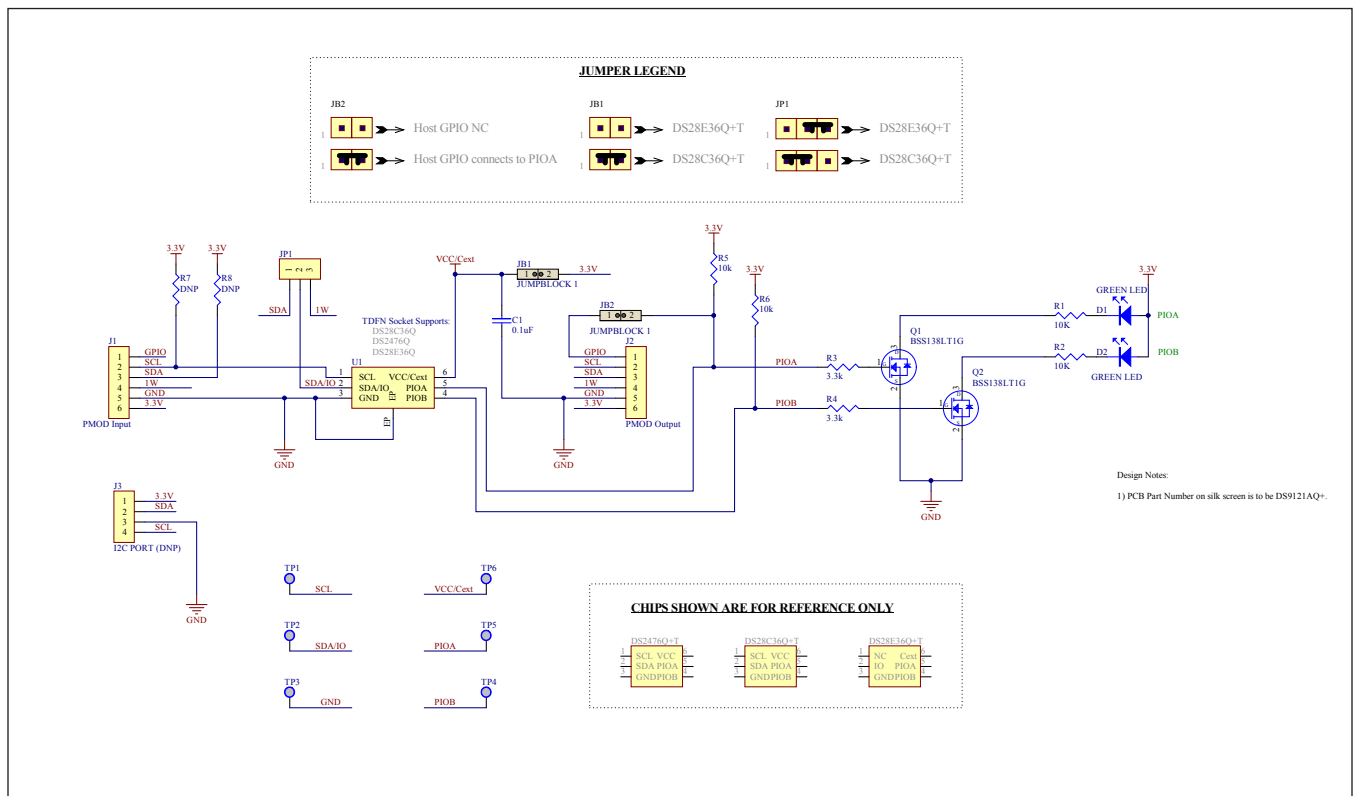

DS9121AQ PCB Layout

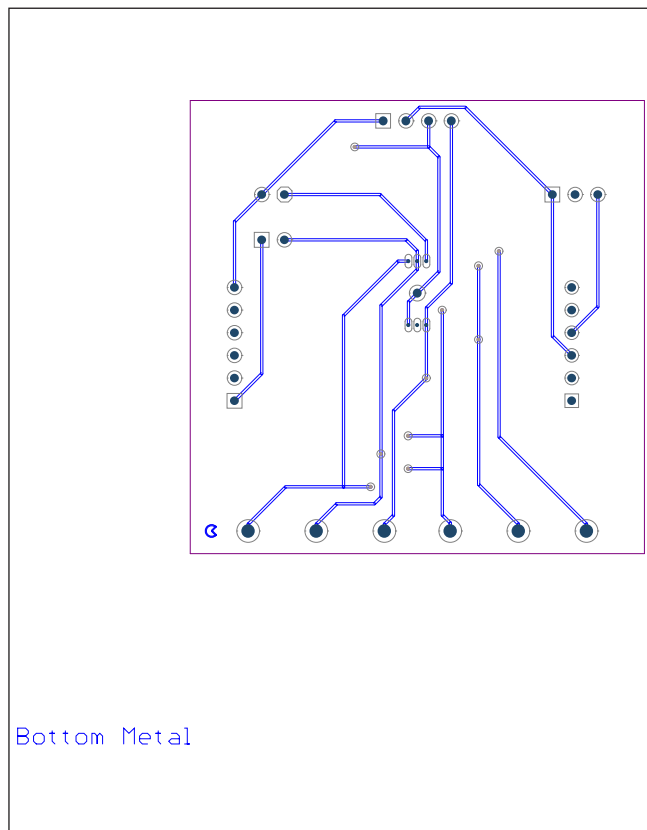
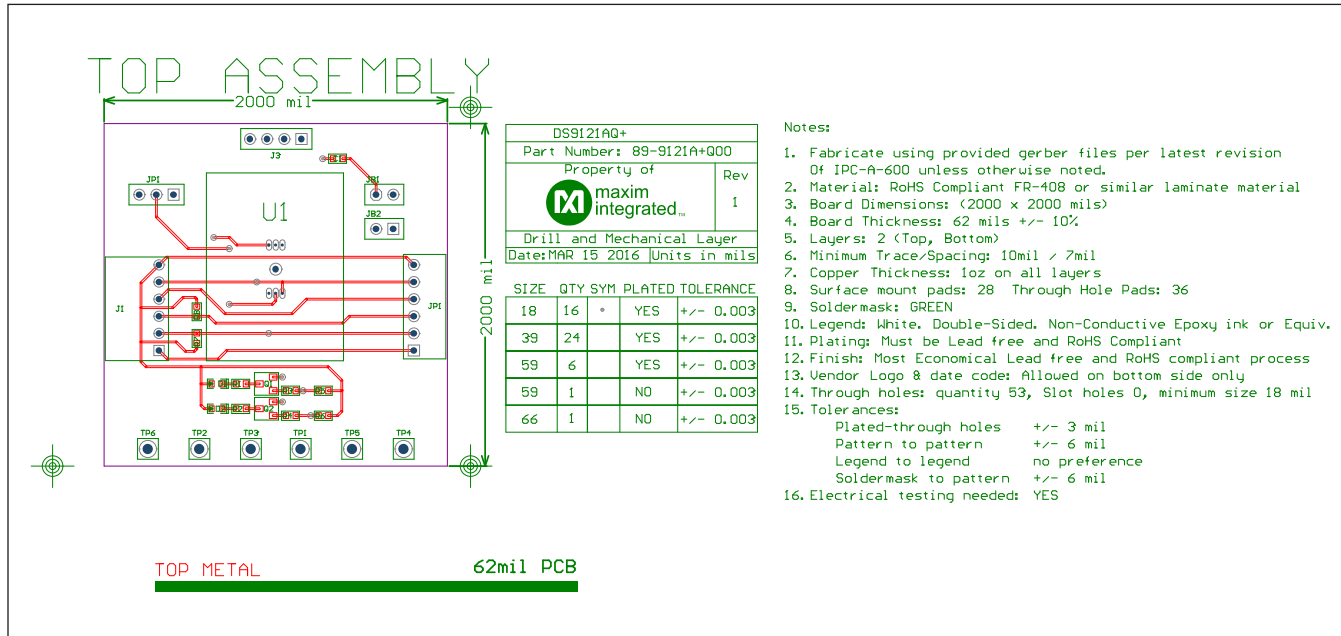

Revision History

REVISION NUMBER	REVISION DATE	DESCRIPTION	PAGES CHANGED
0	12/17	Initial release	—
0.1		Updated broken hyperlinks	2

For pricing, delivery, and ordering information, please contact Maxim Direct at 1-888-629-4642, or visit Maxim Integrated's website at www.maximintegrated.com.

Maxim Integrated cannot assume responsibility for use of any circuitry other than circuitry entirely embodied in a Maxim Integrated product. No circuit patent licenses are implied. Maxim Integrated reserves the right to change the circuitry and specifications without notice at any time.