

Features

- High Performance, Low Power AVR[®] 8-Bit Microcontroller
- Advanced RISC Architecture
 - 120 Powerful Instructions – Most Single Clock Cycle Execution
 - 32 x 8 General Purpose Working Registers
 - Fully Static Operation
 - Up to 20 MIPS Throughput at 20 MHz
- High Endurance Non-volatile Memory segments
 - 1K Bytes of In-System Self-programmable Flash program memory
 - 64 Bytes EEPROM
 - 64 Bytes Internal SRAM
 - Write/Erase cycles: 10,000 Flash/100,000 EEPROM
 - Data retention: 20 years at 85°C/100 years at 25°C (see [page 6](#))
 - Programming Lock for Self-Programming Flash & EEPROM Data Security
- Peripheral Features
 - One 8-bit Timer/Counter with Prescaler and Two PWM Channels
 - 4-channel, 10-bit ADC with Internal Voltage Reference
 - Programmable Watchdog Timer with Separate On-chip Oscillator
 - On-chip Analog Comparator
- Special Microcontroller Features
 - debugWIRE On-chip Debug System
 - In-System Programmable via SPI Port
 - External and Internal Interrupt Sources
 - Low Power Idle, ADC Noise Reduction, and Power-down Modes
 - Enhanced Power-on Reset Circuit
 - Programmable Brown-out Detection Circuit
 - Internal Calibrated Oscillator
- I/O and Packages
 - 8-pin PDIP/SOIC: Six Programmable I/O Lines
 - 20-pad MLF: Six Programmable I/O Lines
- Operating Voltage:
 - 1.8 - 5.5V for ATtiny13V
 - 2.7 - 5.5V for ATtiny13
- Speed Grade
 - ATtiny13V: 0 - 4 MHz @ 1.8 - 5.5V, 0 - 10 MHz @ 2.7 - 5.5V
 - ATtiny13: 0 - 10 MHz @ 2.7 - 5.5V, 0 - 20 MHz @ 4.5 - 5.5V
- Industrial Temperature Range
- Low Power Consumption
 - Active Mode:
 - 1 MHz, 1.8V: 240µA
 - Power-down Mode:
 - < 0.1µA at 1.8V



8-bit AVR[®] Microcontroller with 1K Bytes In-System Programmable Flash

ATtiny13
ATtiny13V

Summary

Not recommended for new designs. Use ATtiny13A.

Rev. 2535IS-AVR-05/08



1. Pin Configurations

Figure 1-1. Pinout ATtiny13/ATtiny13V

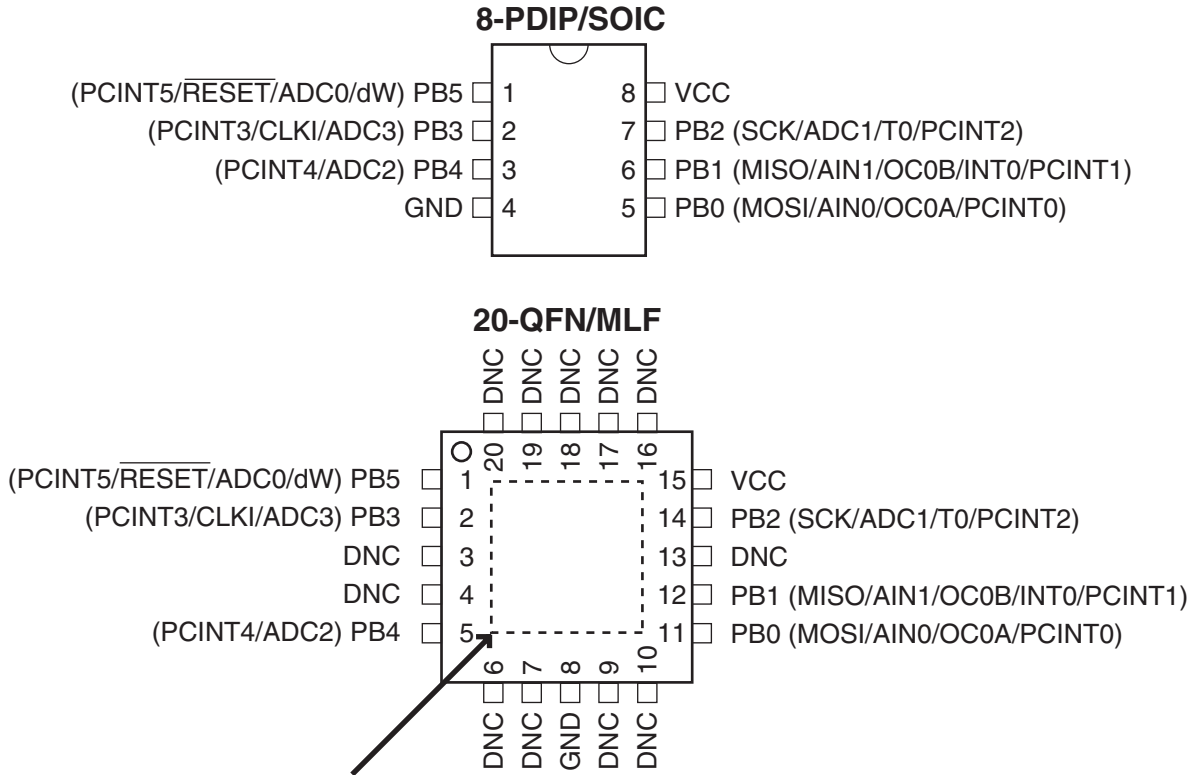

NOTE: Bottom pad should be soldered to ground.
DNC: Do Not Connect

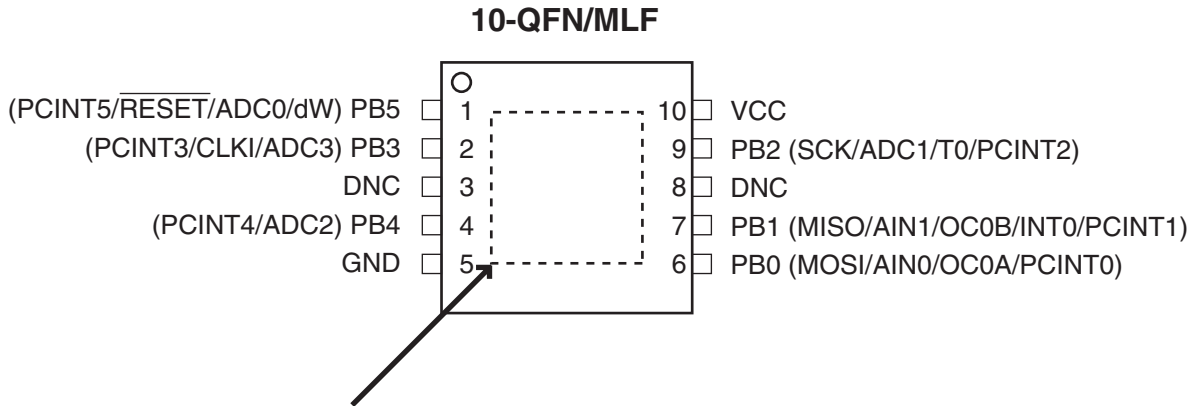

NOTE: Bottom pad should be soldered to ground.
DNC: Do Not Connect

1.1 Pin Descriptions

1.1.1 VCC

Digital supply voltage.

1.1.2 GND

Ground.

1.1.3 Port B (PB5:PB0)

Port B is a 6-bit bi-directional I/O port with internal pull-up resistors (selected for each bit). The Port B output buffers have symmetrical drive characteristics with both high sink and source capability. As inputs, Port B pins that are externally pulled low will source current if the pull-up resistors are activated. The Port B pins are tri-stated when a reset condition becomes active, even if the clock is not running.

Port B also serves the functions of various special features of the ATtiny13 as listed on [page 54](#).

1.1.4 $\overline{\text{RESET}}$

Reset input. A low level on this pin for longer than the minimum pulse length will generate a reset, even if the clock is not running. The minimum pulse length is given in [Table 18-1 on page 115](#). Shorter pulses are not guaranteed to generate a reset.

The reset pin can also be used as a (weak) I/O pin.

2. Overview

The ATtiny13 is a low-power CMOS 8-bit microcontroller based on the AVR enhanced RISC architecture. By executing powerful instructions in a single clock cycle, the ATtiny13 achieves throughputs approaching 1 MIPS per MHz allowing the system designer to optimize power consumption versus processing speed.

2.1 Block Diagram

Figure 2-1. Block Diagram

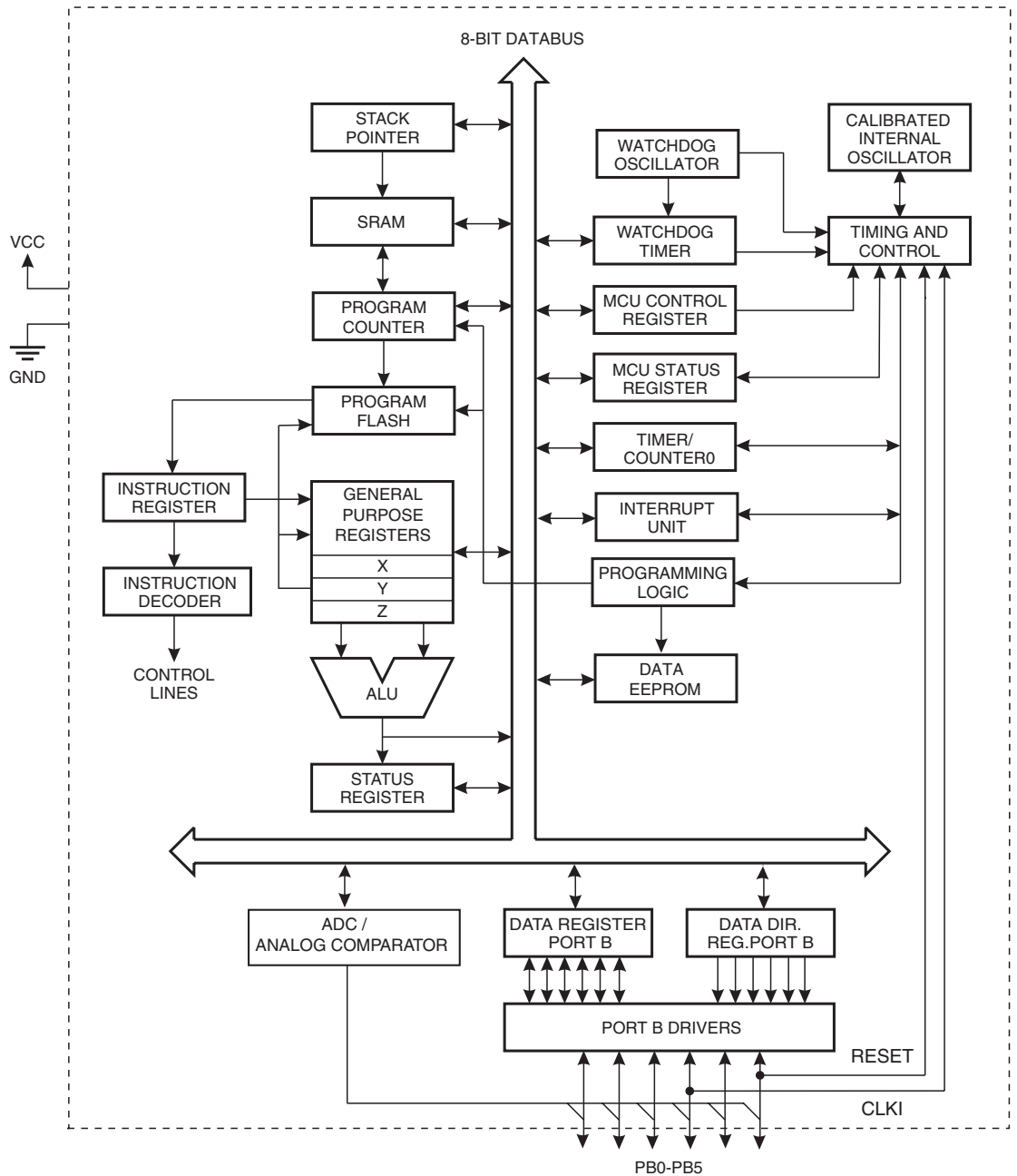

The AVR core combines a rich instruction set with 32 general purpose working registers. All 32 registers are directly connected to the Arithmetic Logic Unit (ALU), allowing two independent registers to be accessed in one single instruction executed in one clock cycle. The resulting architecture is more code efficient while achieving throughputs up to ten times faster than conventional CISC microcontrollers.

The ATtiny13 provides the following features: 1K byte of In-System Programmable Flash, 64 bytes EEPROM, 64 bytes SRAM, 6 general purpose I/O lines, 32 general purpose working registers, one 8-bit Timer/Counter with compare modes, Internal and External Interrupts, a 4-channel, 10-bit ADC, a programmable Watchdog Timer with internal Oscillator, and three software selectable power saving modes. The Idle mode stops the CPU while allowing the SRAM, Timer/Counter, ADC, Analog Comparator, and Interrupt system to continue functioning. The Power-down mode saves the register contents, disabling all chip functions until the next Interrupt or Hardware Reset. The ADC Noise Reduction mode stops the CPU and all I/O modules except ADC, to minimize switching noise during ADC conversions.

The device is manufactured using Atmel's high density non-volatile memory technology. The On-chip ISP Flash allows the Program memory to be re-programmed In-System through an SPI serial interface, by a conventional non-volatile memory programmer or by an On-chip boot code running on the AVR core.

The ATtiny13 AVR is supported with a full suite of program and system development tools including: C Compilers, Macro Assemblers, Program Debugger/Simulators, and Evaluation kits.

3. About

3.1 Resources

A comprehensive set of drivers, application notes, data sheets and descriptions on development tools are available for download at <http://www.atmel.com/avr>.

3.2 Code Examples

This documentation contains simple code examples that briefly show how to use various parts of the device. These code examples assume that the part specific header file is included before compilation. Be aware that not all C compiler vendors include bit definitions in the header files and interrupt handling in C is compiler dependent. Please confirm with the C compiler documentation for more details.

3.3 Data Retention

Reliability Qualification results show that the projected data retention failure rate is much less than 1 PPM over 20 years at 85°C or 100 years at 25°C.

4. Register Summary

Address	Name	Bit 7	Bit 6	Bit 5	Bit 4	Bit 3	Bit 2	Bit 1	Bit 0	Page
0x3F	SREG	I	T	H	S	V	N	Z	C	page 9
0x3E	Reserved	–	–	–	–	–	–	–	–	
0x3D	SPL	SPI[7:0]								page 11
0x3C	Reserved	–								
0x3B	GIMSK	–	INT0	PCIE	–	–	–	–	–	page 46
0x3A	GIFR	–	INTF0	PCIF	–	–	–	–	–	page 47
0x39	TIMSK0	–	–	–	–	OCIE0B	OCIE0A	TOIE0	–	page 74
0x38	TIFR0	–	–	–	–	OCF0B	OCF0A	TOV0	–	page 75
0x37	SPMCSR	–	–	–	CTPB	RFLB	PGWRT	PGERS	SELF-	page 97
0x36	OCR0A	Timer/Counter – Output Compare Register A								page 74
0x35	MCUCR	–	PUD	SE	SM1	SM0	–	ISC01	ISC00	page 32
0x34	MCUSR	–	–	–	–	WDRF	BORF	EXTRF	PORF	page 41
0x33	TCCR0B	FOC0A	FOC0B	–	–	WGM02	CS02	CS01	CS00	page 72
0x32	TCNT0	Timer/Counter (8-bit)								page 73
0x31	OSCCAL	Oscillator Calibration Register								page 27
0x30	Reserved	–								
0x2F	TCCR0A	COM0A1	COM0A0	COM0B1	COM0B0	–	–	WGM01	WGM00	page 69
0x2E	DWDR	DWDR[7:0]								page 96
0x2D	Reserved	–								
0x2C	Reserved	–								
0x2B	Reserved	–								
0x2A	Reserved	–								
0x29	OCR0B	Timer/Counter – Output Compare Register B								page 74
0x28	GTCCR	TSM	–	–	–	–	–	–	PSR10	page 77
0x27	Reserved	–								
0x26	CLKPR	CLKPCE	–	–	–	CLKPS3	CLKPS2	CLKPS1	CLKPS0	page 28
0x25	Reserved	–								
0x24	Reserved	–								
0x23	Reserved	–								
0x22	Reserved	–								
0x21	WDTCR	WDTIF	WDTIE	WDP3	WDCE	WDE	WDP2	WDP1	WDP0	page 41
0x20	Reserved	–								
0x1F	Reserved	–								
0x1E	EEARL	–	–	EEPROM Address Register						page 20
0x1D	EEDR	EEPROM Data Register								page 20
0x1C	EECR	–	–	EEDM1	EEDM0	EERIE	EEMPE	EEPE	EERE	page 21
0x1B	Reserved	–								
0x1A	Reserved	–								
0x19	Reserved	–								
0x18	PORTB	–	–	PORTB5	PORTB4	PORTB3	PORTB2	PORTB1	PORTB0	page 56
0x17	DDRB	–	–	DDB5	DDB4	DDB3	DDB2	DDB1	DDB0	page 56
0x16	PINB	–	–	PINB5	PINB4	PINB3	PINB2	PINB1	PINB0	page 57
0x15	PCMSK	–	–	PCINT5	PCINT4	PCINT3	PCINT2	PCINT1	PCINT0	page 47
0x14	DIDR0	–	–	ADC0D	ADC2D	ADC3D	ADC1D	AIN1D	AIN0D	page 80, page 94
0x13	Reserved	–								
0x12	Reserved	–								
0x11	Reserved	–								
0x10	Reserved	–								
0x0F	Reserved	–								
0x0E	Reserved	–								
0x0D	Reserved	–								
0x0C	Reserved	–								
0x0B	Reserved	–								
0x0A	Reserved	–								
0x09	Reserved	–								
0x08	ACSR	ACD	ACBG	ACO	ACI	ACIE	–	ACIS1	ACIS0	page 79
0x07	ADMUX	–	REFS0	ADLAR	–	–	–	MUX1	MUX0	page 91
0x06	ADCSRA	ADEN	ADSC	ADATE	ADIF	ADIE	ADPS2	ADPS1	ADPS0	page 92
0x05	ADCH	ADC Data Register High Byte								page 93
0x04	ADCL	ADC Data Register Low Byte								page 93
0x03	ADCSRB	–	ACME	–	–	–	ADTS2	ADTS1	ADTS0	page 94
0x02	Reserved	–								
0x01	Reserved	–								
0x00	Reserved	–								



- Notes:
1. For compatibility with future devices, reserved bits should be written to zero if accessed. Reserved I/O memory addresses should never be written.
 2. I/O Registers within the address range 0x00 - 0x1F are directly bit-accessible using the SBI and CBI instructions. In these registers, the value of single bits can be checked by using the SBIS and SBIC instructions. Some of the Status Flags are cleared by writing a logical one to them. Note that, unlike most other AVR's, the CBI and SBI instructions will only operate on the specified bit, and can therefore be used on registers containing such Status Flags. The CBI and SBI instructions work with registers 0x00 to 0x1F only.

5. Instruction Set Summary

Mnemonics	Operands	Description	Operation	Flags	#Clocks
ARITHMETIC AND LOGIC INSTRUCTIONS					
ADD	Rd, Rr	Add two Registers	$Rd \leftarrow Rd + Rr$	Z,C,N,V,H	1
ADC	Rd, Rr	Add with Carry two Registers	$Rd \leftarrow Rd + Rr + C$	Z,C,N,V,H	1
ADIW	Rd,K	Add Immediate to Word	$RdH:RdL \leftarrow RdH:RdL + K$	Z,C,N,V,S	2
SUB	Rd, Rr	Subtract two Registers	$Rd \leftarrow Rd - Rr$	Z,C,N,V,H	1
SUBI	Rd, K	Subtract Constant from Register	$Rd \leftarrow Rd - K$	Z,C,N,V,H	1
SBC	Rd, Rr	Subtract with Carry two Registers	$Rd \leftarrow Rd - Rr - C$	Z,C,N,V,H	1
SBCI	Rd, K	Subtract with Carry Constant from Reg.	$Rd \leftarrow Rd - K - C$	Z,C,N,V,H	1
SBIW	Rd,K	Subtract Immediate from Word	$RdH:RdL \leftarrow RdH:RdL - K$	Z,C,N,V,S	2
AND	Rd, Rr	Logical AND Registers	$Rd \leftarrow Rd \bullet Rr$	Z,N,V	1
ANDI	Rd, K	Logical AND Register and Constant	$Rd \leftarrow Rd \bullet K$	Z,N,V	1
OR	Rd, Rr	Logical OR Registers	$Rd \leftarrow Rd \vee Rr$	Z,N,V	1
ORI	Rd, K	Logical OR Register and Constant	$Rd \leftarrow Rd \vee K$	Z,N,V	1
EOR	Rd, Rr	Exclusive OR Registers	$Rd \leftarrow Rd \oplus Rr$	Z,N,V	1
COM	Rd	One's Complement	$Rd \leftarrow 0xFF - Rd$	Z,C,N,V	1
NEG	Rd	Two's Complement	$Rd \leftarrow 0x00 - Rd$	Z,C,N,V,H	1
SBR	Rd,K	Set Bit(s) in Register	$Rd \leftarrow Rd \vee K$	Z,N,V	1
CBR	Rd,K	Clear Bit(s) in Register	$Rd \leftarrow Rd \bullet (\text{OxFF} - K)$	Z,N,V	1
INC	Rd	Increment	$Rd \leftarrow Rd + 1$	Z,N,V	1
DEC	Rd	Decrement	$Rd \leftarrow Rd - 1$	Z,N,V	1
TST	Rd	Test for Zero or Minus	$Rd \leftarrow Rd \bullet Rd$	Z,N,V	1
CLR	Rd	Clear Register	$Rd \leftarrow Rd \oplus Rd$	Z,N,V	1
SER	Rd	Set Register	$Rd \leftarrow 0xFF$	None	1
BRANCH INSTRUCTIONS					
RJMP	k	Relative Jump	$PC \leftarrow PC + k + 1$	None	2
IJMP		Indirect Jump to (Z)	$PC \leftarrow Z$	None	2
RCALL	k	Relative Subroutine Call	$PC \leftarrow PC + k + 1$	None	3
ICALL		Indirect Call to (Z)	$PC \leftarrow Z$	None	3
RET		Subroutine Return	$PC \leftarrow STACK$	None	4
RETI		Interrupt Return	$PC \leftarrow STACK$	I	4
CPSE	Rd,Rr	Compare, Skip if Equal	if (Rd = Rr) $PC \leftarrow PC + 2$ or 3	None	1/2/3
CP	Rd,Rr	Compare	$Rd - Rr$	Z, N,V,C,H	1
CPC	Rd,Rr	Compare with Carry	$Rd - Rr - C$	Z, N,V,C,H	1
CPI	Rd,K	Compare Register with Immediate	$Rd - K$	Z, N,V,C,H	1
SBRC	Rr, b	Skip if Bit in Register Cleared	if (Rr(b)=0) $PC \leftarrow PC + 2$ or 3	None	1/2/3
SBRS	Rr, b	Skip if Bit in Register is Set	if (Rr(b)=1) $PC \leftarrow PC + 2$ or 3	None	1/2/3
SBIC	P, b	Skip if Bit in I/O Register Cleared	if (P(b)=0) $PC \leftarrow PC + 2$ or 3	None	1/2/3
SBIS	P, b	Skip if Bit in I/O Register is Set	if (P(b)=1) $PC \leftarrow PC + 2$ or 3	None	1/2/3
BRBS	s, k	Branch if Status Flag Set	if (SREG(s) = 1) then $PC \leftarrow PC + k + 1$	None	1/2
BRBC	s, k	Branch if Status Flag Cleared	if (SREG(s) = 0) then $PC \leftarrow PC + k + 1$	None	1/2
BRREQ	k	Branch if Equal	if (Z = 1) then $PC \leftarrow PC + k + 1$	None	1/2
BRNE	k	Branch if Not Equal	if (Z = 0) then $PC \leftarrow PC + k + 1$	None	1/2
BRCS	k	Branch if Carry Set	if (C = 1) then $PC \leftarrow PC + k + 1$	None	1/2
BRCC	k	Branch if Carry Cleared	if (C = 0) then $PC \leftarrow PC + k + 1$	None	1/2
BRSH	k	Branch if Same or Higher	if (C = 0) then $PC \leftarrow PC + k + 1$	None	1/2
BRLO	k	Branch if Lower	if (C = 1) then $PC \leftarrow PC + k + 1$	None	1/2
BRMI	k	Branch if Minus	if (N = 1) then $PC \leftarrow PC + k + 1$	None	1/2
BRPL	k	Branch if Plus	if (N = 0) then $PC \leftarrow PC + k + 1$	None	1/2
BRGE	k	Branch if Greater or Equal, Signed	if (N \oplus V = 0) then $PC \leftarrow PC + k + 1$	None	1/2
BRLT	k	Branch if Less Than Zero, Signed	if (N \oplus V = 1) then $PC \leftarrow PC + k + 1$	None	1/2
BRHS	k	Branch if Half Carry Flag Set	if (H = 1) then $PC \leftarrow PC + k + 1$	None	1/2
BRHC	k	Branch if Half Carry Flag Cleared	if (H = 0) then $PC \leftarrow PC + k + 1$	None	1/2
BRTS	k	Branch if T Flag Set	if (T = 1) then $PC \leftarrow PC + k + 1$	None	1/2
BRTC	k	Branch if T Flag Cleared	if (T = 0) then $PC \leftarrow PC + k + 1$	None	1/2
BRVS	k	Branch if Overflow Flag is Set	if (V = 1) then $PC \leftarrow PC + k + 1$	None	1/2
BRVC	k	Branch if Overflow Flag is Cleared	if (V = 0) then $PC \leftarrow PC + k + 1$	None	1/2
BRIE	k	Branch if Interrupt Enabled	if (I = 1) then $PC \leftarrow PC + k + 1$	None	1/2
BRID	k	Branch if Interrupt Disabled	if (I = 0) then $PC \leftarrow PC + k + 1$	None	1/2
BIT AND BIT-TEST INSTRUCTIONS					
SBI	P,b	Set Bit in I/O Register	$I/O(P,b) \leftarrow 1$	None	2
CBI	P,b	Clear Bit in I/O Register	$I/O(P,b) \leftarrow 0$	None	2
LSL	Rd	Logical Shift Left	$Rd(n+1) \leftarrow Rd(n), Rd(0) \leftarrow 0$	Z,C,N,V	1
LSR	Rd	Logical Shift Right	$Rd(n) \leftarrow Rd(n+1), Rd(7) \leftarrow 0$	Z,C,N,V	1
ROL	Rd	Rotate Left Through Carry	$Rd(0) \leftarrow C, Rd(n+1) \leftarrow Rd(n), C \leftarrow Rd(7)$	Z,C,N,V	1

Mnemonics	Operands	Description	Operation	Flags	#Clocks
ROR	Rd	Rotate Right Through Carry	$Rd(7) \leftarrow C, Rd(n) \leftarrow Rd(n+1), C \leftarrow Rd(0)$	Z,C,N,V	1
ASR	Rd	Arithmetic Shift Right	$Rd(n) \leftarrow Rd(n+1), n=0..6$	Z,C,N,V	1
SWAP	Rd	Swap Nibbles	$Rd(3..0) \leftarrow Rd(7..4), Rd(7..4) \leftarrow Rd(3..0)$	None	1
BSET	s	Flag Set	$SREG(s) \leftarrow 1$	SREG(s)	1
BCLR	s	Flag Clear	$SREG(s) \leftarrow 0$	SREG(s)	1
BST	Rr, b	Bit Store from Register to T	$T \leftarrow Rr(b)$	T	1
BLD	Rd, b	Bit load from T to Register	$Rd(b) \leftarrow T$	None	1
SEC		Set Carry	$C \leftarrow 1$	C	1
CLC		Clear Carry	$C \leftarrow 0$	C	1
SEN		Set Negative Flag	$N \leftarrow 1$	N	1
CLN		Clear Negative Flag	$N \leftarrow 0$	N	1
SEZ		Set Zero Flag	$Z \leftarrow 1$	Z	1
CLZ		Clear Zero Flag	$Z \leftarrow 0$	Z	1
SEI		Global Interrupt Enable	$I \leftarrow 1$	I	1
CLI		Global Interrupt Disable	$I \leftarrow 0$	I	1
SES		Set Signed Test Flag	$S \leftarrow 1$	S	1
CLS		Clear Signed Test Flag	$S \leftarrow 0$	S	1
SEV		Set Twos Complement Overflow	$V \leftarrow 1$	V	1
CLV		Clear Twos Complement Overflow	$V \leftarrow 0$	V	1
SET		Set T in SREG	$T \leftarrow 1$	T	1
CLT		Clear T in SREG	$T \leftarrow 0$	T	1
SEH		Set Half Carry Flag in SREG	$H \leftarrow 1$	H	1
CLH		Clear Half Carry Flag in SREG	$H \leftarrow 0$	H	1
DATA TRANSFER INSTRUCTIONS					
MOV	Rd, Rr	Move Between Registers	$Rd \leftarrow Rr$	None	1
MOVW	Rd, Rr	Copy Register Word	$Rd+1:Rd \leftarrow Rr+1:Rr$	None	1
LDI	Rd, K	Load Immediate	$Rd \leftarrow K$	None	1
LD	Rd, X	Load Indirect	$Rd \leftarrow (X)$	None	2
LD	Rd, X+	Load Indirect and Post-Inc.	$Rd \leftarrow (X), X \leftarrow X + 1$	None	2
LD	Rd, -X	Load Indirect and Pre-Dec.	$X \leftarrow X - 1, Rd \leftarrow (X)$	None	2
LD	Rd, Y	Load Indirect	$Rd \leftarrow (Y)$	None	2
LD	Rd, Y+	Load Indirect and Post-Inc.	$Rd \leftarrow (Y), Y \leftarrow Y + 1$	None	2
LD	Rd, -Y	Load Indirect and Pre-Dec.	$Y \leftarrow Y - 1, Rd \leftarrow (Y)$	None	2
LDD	Rd, Y+q	Load Indirect with Displacement	$Rd \leftarrow (Y + q)$	None	2
LD	Rd, Z	Load Indirect	$Rd \leftarrow (Z)$	None	2
LD	Rd, Z+	Load Indirect and Post-Inc.	$Rd \leftarrow (Z), Z \leftarrow Z + 1$	None	2
LD	Rd, -Z	Load Indirect and Pre-Dec.	$Z \leftarrow Z - 1, Rd \leftarrow (Z)$	None	2
LDD	Rd, Z+q	Load Indirect with Displacement	$Rd \leftarrow (Z + q)$	None	2
LDS	Rd, k	Load Direct from SRAM	$Rd \leftarrow (k)$	None	2
ST	X, Rr	Store Indirect	$(X) \leftarrow Rr$	None	2
ST	X+, Rr	Store Indirect and Post-Inc.	$(X) \leftarrow Rr, X \leftarrow X + 1$	None	2
ST	-X, Rr	Store Indirect and Pre-Dec.	$X \leftarrow X - 1, (X) \leftarrow Rr$	None	2
ST	Y, Rr	Store Indirect	$(Y) \leftarrow Rr$	None	2
ST	Y+, Rr	Store Indirect and Post-Inc.	$(Y) \leftarrow Rr, Y \leftarrow Y + 1$	None	2
ST	-Y, Rr	Store Indirect and Pre-Dec.	$Y \leftarrow Y - 1, (Y) \leftarrow Rr$	None	2
STD	Y+q, Rr	Store Indirect with Displacement	$(Y + q) \leftarrow Rr$	None	2
ST	Z, Rr	Store Indirect	$(Z) \leftarrow Rr$	None	2
ST	Z+, Rr	Store Indirect and Post-Inc.	$(Z) \leftarrow Rr, Z \leftarrow Z + 1$	None	2
ST	-Z, Rr	Store Indirect and Pre-Dec.	$Z \leftarrow Z - 1, (Z) \leftarrow Rr$	None	2
STD	Z+q, Rr	Store Indirect with Displacement	$(Z + q) \leftarrow Rr$	None	2
STS	k, Rr	Store Direct to SRAM	$(k) \leftarrow Rr$	None	2
LPM		Load Program Memory	$R0 \leftarrow (Z)$	None	3
LPM	Rd, Z	Load Program Memory	$Rd \leftarrow (Z)$	None	3
LPM	Rd, Z+	Load Program Memory and Post-Inc	$Rd \leftarrow (Z), Z \leftarrow Z + 1$	None	3
SPM		Store Program Memory	$(z) \leftarrow R1:R0$	None	
IN	Rd, P	In Port	$Rd \leftarrow P$	None	1
OUT	P, Rr	Out Port	$P \leftarrow Rr$	None	1
PUSH	Rr	Push Register on Stack	$STACK \leftarrow Rr$	None	2
POP	Rd	Pop Register from Stack	$Rd \leftarrow STACK$	None	2
MCU CONTROL INSTRUCTIONS					
NOP		No Operation		None	1
SLEEP		Sleep	(see specific descr. for Sleep function)	None	1
WDR		Watchdog Reset	(see specific descr. for WDR/Timer)	None	1
BREAK		Break	For On-chip Debug Only	None	N/A

6. Ordering Information

Speed (MHz) ⁽³⁾	Power Supply	Ordering Code ⁽²⁾	Package ⁽¹⁾	Operation Range
10	1.8 - 5.5	ATtiny13V-10PU ATtiny13V-10SU ATtiny13V-10SSU ATtiny13V-10MU ATtiny13V-10MMU	8P3 8S2 S8S1 20M1 10M1	Industrial (-40°C to 85°C)
20	2.7 - 5.5	ATtiny13-20PU ATtiny13-20SU ATtiny13-20SSU ATtiny13-20MU ATtiny13-20MMU	8P3 8S2 S8S1 20M1 10M1	Industrial (-40°C to 85°C)

- Notes:
1. This device can also be supplied in wafer form. Please contact your local Atmel sales office for detailed ordering information and minimum quantities.
 2. Pb-free packaging alternative, complies to the European Directive for Restriction of Hazardous Substances (RoHS directive). Also Halide free and fully Green
 3. For Speed vs. V_{CC} , see ["Speed Grades" on page 117](#).

Package Type	
8P3	8-lead, 0.300" Wide, Plastic Dual Inline Package (PDIP)
8S2	8-lead, 0.209" Wide, Plastic Small Outline Package (EIAJ SOIC)
S8S1	8-lead, 0.150" Wide, Plastic Gull-Wing Small Outline (JEDEC SOIC)
20M1	20-pad, 4 x 4 x 0.8 mm Body, Lead Pitch 0.50 mm, Micro Lead Frame Package (MLF)
10M1	10-pad, 3 x 3 x 1 mm Body, Lead Pitch 0.50 mm, Micro Lead Frame Package (MLF)

7. Packaging Information

7.1 8P3

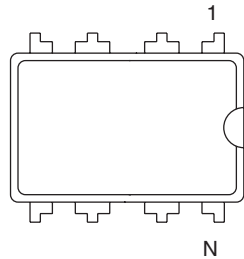

Top View

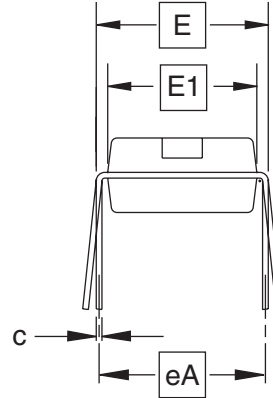

End View

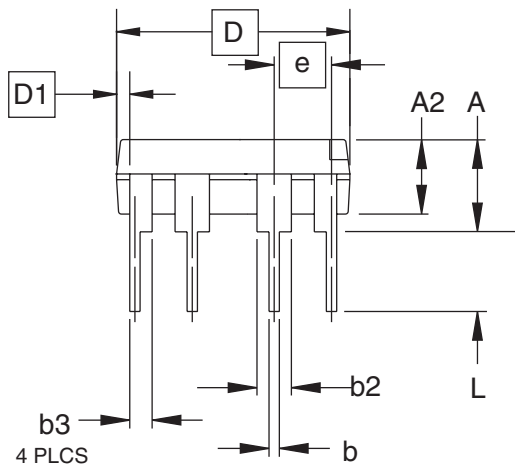

Side View

COMMON DIMENSIONS
(Unit of Measure = inches)

SYMBOL	MIN	NOM	MAX	NOTE
A			0.210	2
A2	0.115	0.130	0.195	
b	0.014	0.018	0.022	5
b2	0.045	0.060	0.070	6
b3	0.030	0.039	0.045	6
c	0.008	0.010	0.014	
D	0.355	0.365	0.400	3
D1	0.005			3
E	0.300	0.310	0.325	4
E1	0.240	0.250	0.280	3
e	0.100 BSC			
eA	0.300 BSC			4
L	0.115	0.130	0.150	2

- Notes:
1. This drawing is for general information only; refer to JEDEC Drawing MS-001, Variation BA for additional information.
 2. Dimensions A and L are measured with the package seated in JEDEC seating plane Gauge GS-3.
 3. D, D1 and E1 dimensions do not include mold Flash or protrusions. Mold Flash or protrusions shall not exceed 0.010 inch.
 4. E and eA measured with the leads constrained to be perpendicular to datum.
 5. Pointed or rounded lead tips are preferred to ease insertion.
 6. b2 and b3 maximum dimensions do not include Dambar protrusions. Dambar protrusions shall not exceed 0.010 (0.25 mm).

01/09/02



2325 Orchard Parkway
San Jose, CA 95131

TITLE

8P3, 8-lead, 0.300" Wide Body, Plastic Dual
In-line Package (PDIP)

DRAWING NO.

8P3

REV.

B

7.2 8S2

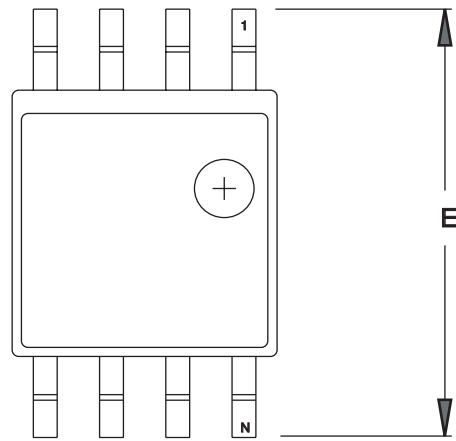

TOP VIEW

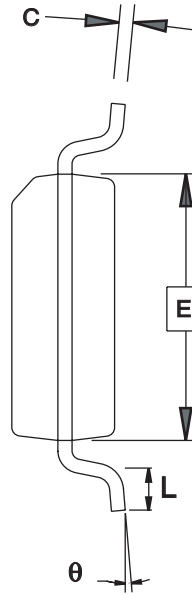

END VIEW

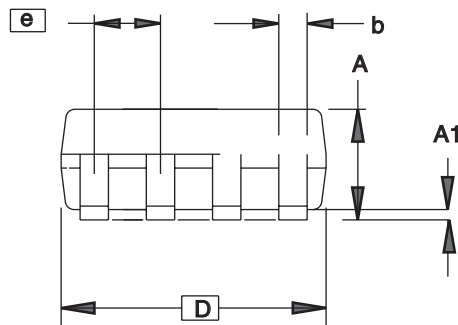

SIDE VIEW

COMMON DIMENSIONS
(Unit of Measure = mm)

SYMBOL	MIN	NOM	MAX	NOTE
A	1.70		2.16	
A1	0.05		0.25	
b	0.35		0.48	4
C	0.15		0.35	4
D	5.13		5.35	
E1	5.18		5.40	2
E	7.70		8.26	
L	0.51		0.85	
θ	0°		8°	
e	1.27 BSC			3

- Notes: 1. This drawing is for general information only; refer to EIAJ Drawing EDR-7320 for additional information.
 2. Mismatch of the upper and lower dies and resin burrs aren't included.
 3. Determines the true geometric position.
 4. Values b,C apply to plated terminal. The standard thickness of the plating layer shall measure between 0.007 to .021 mm.

4/15/08

 Package Drawing Contact: packagedrawings@atmel.com	TITLE 8S2, 8-lead, 0.208" Body, Plastic Small Outline Package (EIAJ)	GPC	DRAWING NO.	REV.
		STN	8S2	F

7.3 S8S1

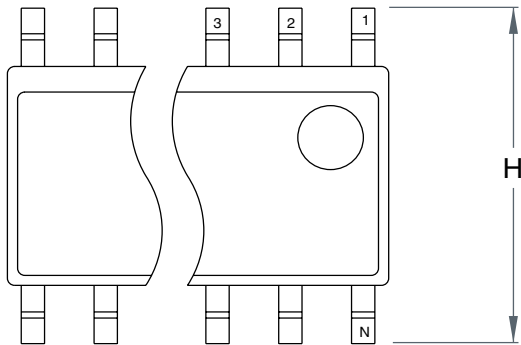

Top View

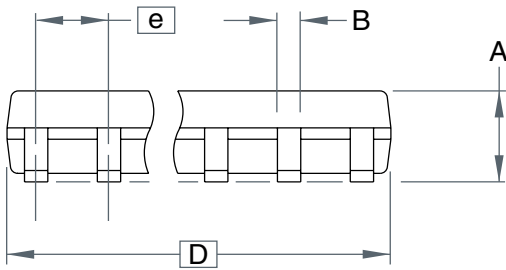

Side View

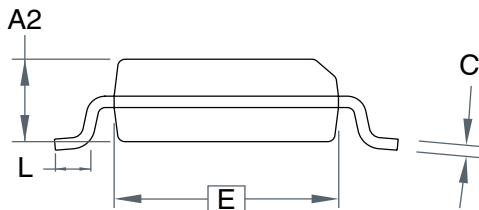

End View

COMMON DIMENSIONS
(Unit of Measure = mm)

SYMBOL	MIN	NOM	MAX	NOTE
A	-	-	1.75	
B	-	-	0.51	
C	-	-	0.25	
D	-	-	5.00	
E	-	-	4.00	
e	1.27 BSC			
H	-	-	6.20	
L	-	-	1.27	

Note: This drawing is for general information only. Refer to JEDEC Drawing MS-012 for proper dimensions, tolerances, datums, etc.

10/10/01



2325 Orchard Parkway
San Jose, CA 95131

TITLE
8S1, 8-lead (0.150" Wide Body), Plastic Gull Wing
Small Outline (JEDEC SOIC)

DRAWING NO.
8S1

REV.
A

7.4 20M1

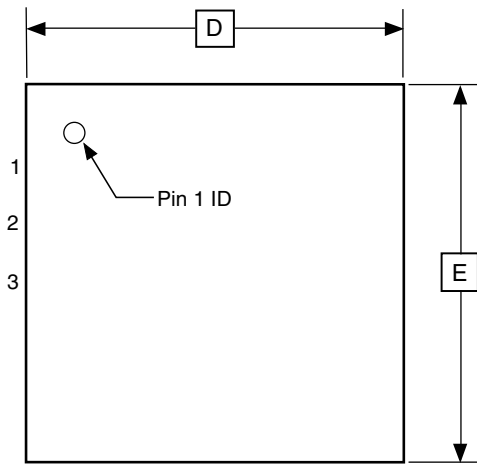

TOP VIEW

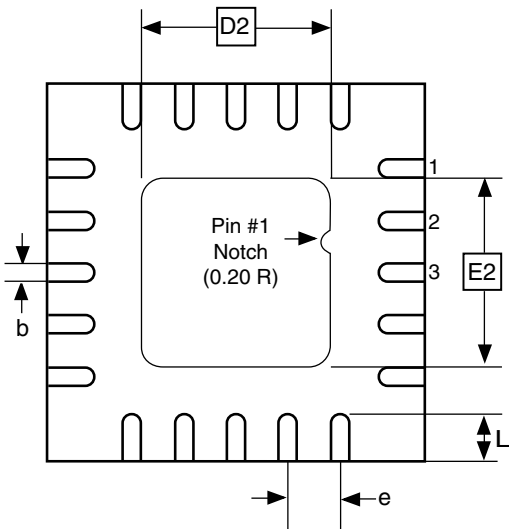

BOTTOM VIEW

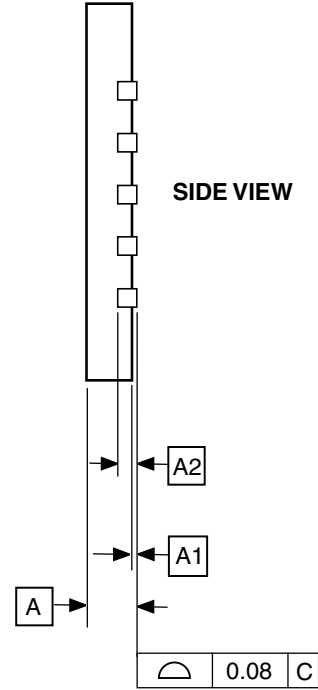

COMMON DIMENSIONS
(Unit of Measure = mm)

SYMBOL	MIN	NOM	MAX	NOTE
A	0.70	0.75	0.80	
A1	-	0.01	0.05	
A2	0.20 REF			
b	0.18	0.23	0.30	
D	4.00 BSC			
D2	2.45	2.60	2.75	
E	4.00 BSC			
E2	2.45	2.60	2.75	
e	0.50 BSC			
L	0.35	0.40	0.55	

Note: Reference JEDEC Standard MO-220, Fig.1 (SAW Singulation) WGGD-5.

10/27/04



2325 Orchard Parkway
San Jose, CA 95131

TITLE

20M1, 20-pad, 4 x 4 x 0.8 mm Body, Lead Pitch 0.50 mm,
2.6 mm Exposed Pad, Micro Lead Frame Package (MLF)

DRAWING NO.

20M1

REV.

A



7.5 10M1

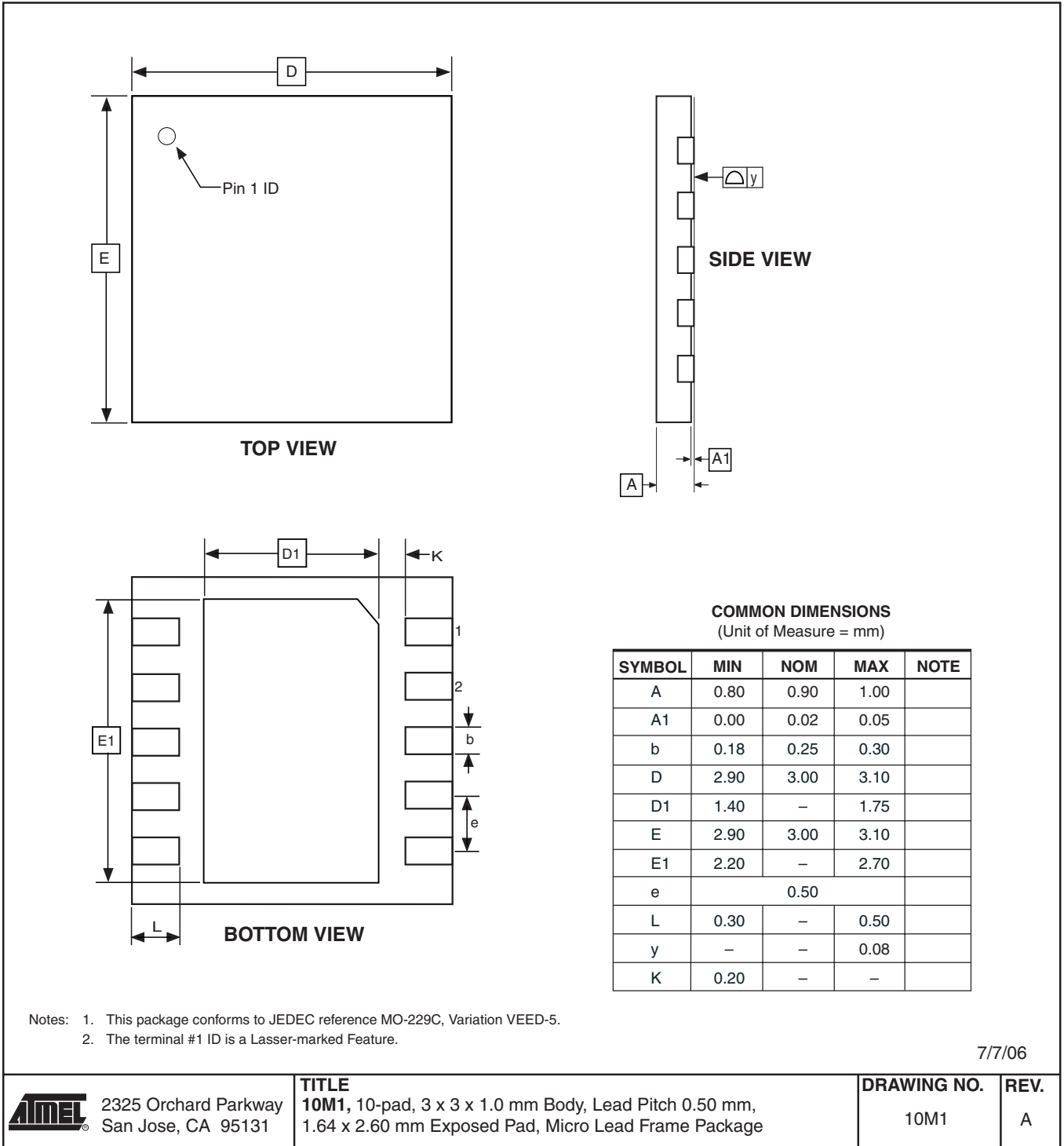

8. Errata

The revision letter in this section refers to the revision of the ATtiny13 device.

8.1 ATtiny13 Rev. D

- **EEPROM can not be written below 1.9 Volt**

1. EEPROM can not be written below 1.9 Volt

Writing the EEPROM at V_{CC} below 1.9 volts might fail.

Problem Fix/Workaround

Do not write the EEPROM when V_{CC} is below 1.9 volts.

8.2 ATtiny13 Rev. C

Revision C has not been sampled.

8.3 ATtiny13 Rev. B

- **Wrong values read after Erase Only operation**
- **High Voltage Serial Programming Flash, EEPROM, Fuse and Lock Bits may fail**
- **Device may lock for further programming**
- **debugWIRE communication not blocked by lock-bits**
- **Watchdog Timer Interrupt disabled**
- **EEPROM can not be written below 1.9 Volt**

8.3.1 Wrong values read after Erase Only operation

At supply voltages below 2.7 V, an EEPROM location that is erased by the Erase Only operation may read as programmed (0x00).

Problem Fix/Workaround

If it is necessary to read an EEPROM location after Erase Only, use an Atomic Write operation with 0xFF as data in order to erase a location. In any case, the Write Only operation can be used as intended. Thus no special considerations are needed as long as the erased location is not read before it is programmed.

8.3.2 High Voltage Serial Programming Flash, EEPROM, Fuse and Lock Bits may fail

Writing to any of these locations and bits may in some occasions fail.

Problem Fix/Workaround

After a writing has been initiated, always observe the RDY/\overline{BSY} signal. If the writing should fail, rewrite until the RDY/\overline{BSY} verifies a correct writing. This will be fixed in revision D.

8.3.3 Device may lock for further programming

Special combinations of fuse bits will lock the device for further programming effectively turning it into an OTP device. The following combinations of settings/fuse bits will cause this effect:

- 128 kHz internal oscillator ($CKSEL[1..0] = 11$), shortest start-up time ($SUT[1..0] = 00$), Debugwire enabled ($DWEN = 0$) or Reset disabled $RSTDISBL = 0$.
- 9.6 MHz internal oscillator ($CKSEL[1..0] = 10$), shortest start-up time ($SUT[1..0] = 00$), Debugwire enabled ($DWEN = 0$) or Reset disabled $RSTDISBL = 0$.

- 4.8 MHz internal oscillator (CKSEL[1..0] = 01), shortest start-up time (SUT[1..0] = 00), Debugwire enabled (DWEN = 0) or Reset disabled RSTDISBL = 0.

Problem fix/ Workaround

Avoid the above fuse combinations. Selecting longer start-up time will eliminate the problem.

8.3.4 debugWIRE communication not blocked by lock-bits

When debugWIRE on-chip debug is enabled (DWEN = 0), the contents of program memory and EEPROM data memory can be read even if the lock-bits are set to block further reading of the device.

Problem fix/ Workaround

Do not ship products with on-chip debug of the tiny13 enabled.

8.3.5 Watchdog Timer Interrupt disabled

If the watchdog timer interrupt flag is not cleared before a new timeout occurs, the watchdog will be disabled, and the interrupt flag will automatically be cleared. This is only applicable in interrupt only mode. If the Watchdog is configured to reset the device in the watchdog time-out following an interrupt, the device works correctly.

Problem fix / Workaround

Make sure there is enough time to always service the first timeout event before a new watchdog timeout occurs. This is done by selecting a long enough time-out period.

8.3.6 EEPROM can not be written below 1.9 Volt

Writing the EEPROM at V_{CC} below 1.9 volts might fail.

Problem Fix/Workaround

Do not write the EEPROM when V_{CC} is below 1.9 volts.

8.4 ATtiny13 Rev. A

Revision A has not been sampled.

9. Datasheet Revision History

Please note that page numbers in this section are referring to this document.

9.1 Rev. 2535I-05/08

1. Updated document template, layout and paragraph formats.
2. Updated “Features” on page 1.
3. Created Sections:
 - “Calibrated Internal RC Oscillator Accuracy” on page 118
 - “Analog Comparator Characteristics” on page 119
4. Updated Sections:
 - “System Clock and Clock Options” on page 23
 - “Calibrated Internal 4.8/9.6 MHz Oscillator” on page 25
 - “External Interrupts” on page 45
 - “Analog Noise Canceling Techniques” on page 88
 - “Limitations of debugWIRE” on page 96
 - “Reading Fuse and Lock Bits from Firmware” on page 99
 - “Fuse Bytes” on page 103
 - “Calibration Bytes” on page 104
 - “High-Voltage Serial Programming” on page 108
 - “Ordering Information” on page 11
5. Updated Figure:
 - “Analog Input Circuitry” on page 87
 - “High-voltage Serial Programming Timing” on page 122
6. Moved Figures:
 - “Serial Programming Timing” on page 121
 - “Serial Programming Waveform” on page 121
 - “High-voltage Serial Programming Timing” on page 122
7. Updated Tables:
 - “DC Characteristics, TA = -40xC to 85xC” on page 115
 - “Serial Programming Characteristics, TA = -40xC to 85xC, VCC = 1.8 - 5.5V (Unless Otherwise Noted)” on page 121
8. Moved Tables:
 - “Serial Programming Instruction Set” on page 107
 - “Serial Programming Characteristics, TA = -40xC to 85xC, VCC = 1.8 - 5.5V (Unless Otherwise Noted)” on page 121
 - “High-voltage Serial Programming Characteristics TA = 25xC, VCC = 5.0V ± 10% (Unless otherwise noted)” on page 122
9. Updated Register Description for Sections:
 - “TCR0A – Timer/Counter Control Register A” on page 69
 - “DIDR0 – Digital Input Disable Register 0” on page 94
10. Updated description in Step 1. on page 106.
11. Changed device status to “Not Recommended for New Designs”.

9.2 Rev. 2535H-10/07

1. Updated “Features” on page 1.
2. Updated “Pin Configurations” on page 2.
3. Added “Data Retention” on page 6.
4. Updated “Assembly Code Example(1)” on page 39.
5. Updated Table 21 in “Alternate Functions of Port B” on page 54.
6. Updated Bit 5 description in “GIMSK – General Interrupt Mask Register” on page 46.
7. Updated “ADC Voltage Reference” on page 87.
8. Updated “Calibration Bytes” on page 104.
9. Updated “Read Calibration Byte” on page 108.
10. Updated Table 51 in “Serial Programming Characteristics” on page 121.
11. Updated Algorithm in “High-Voltage Serial Programming Algorithm” on page 109.
12. Updated “Read Calibration Byte” on page 112.
13. Updated values in “External Clock Drive” on page 118.
14. Updated “Ordering Information” on page 11.
15. Updated “Packaging Information” on page 12.

9.3 Rev. 2535G-01/07

1. Removed Preliminary.
2. Updated Table 7-1 on page 30, Table 8-1 on page 42, Table 18-8 on page 121.
3. Removed Note from Table 7-1 on page 30.
4. Updated “Bit 6 – ADBG: Analog Comparator Bandgap Select” on page 79.
5. Updated “Prescaling and Conversion Timing” on page 83.
6. Updated Figure 18-4 on page 121.
7. Updated “DC Characteristics” on page 115.
8. Updated “Ordering Information” on page 11.
9. Updated “Packaging Information” on page 12.

9.4 Rev. 2535F-04/06

1. Revision not published.

9.5 Rev. 2535E-10/04

1. Bits EEMWE/EEWE changed to EEMPE/EEPE in document.
2. Updated “Pinout ATtiny13/ATtiny13V” on page 2.
3. Updated “Write Fuse Low Bits” in Table 17-13 on page 110, Table 18-3 on page 118.
2. Added “Pin Change Interrupt Timing” on page 45.
4. Updated “GIMSK – General Interrupt Mask Register” on page 46.
5. Updated “PCMSK – Pin Change Mask Register” on page 47.
6. Updated item 4 in “Serial Programming Algorithm” on page 106.
7. Updated “High-Voltage Serial Programming Algorithm” on page 109.
8. Updated “DC Characteristics” on page 115.
9. Updated “Typical Characteristics” on page 122.
10. Updated “Ordering Information” on page 11.
11. Updated “Packaging Information” on page 12.
12. Updated “Errata” on page 17.

9.6 Rev. 2535D-04/04

1. Maximum Speed Grades changed
 - 12MHz to 10MHz
 - 24MHz to 20MHz
2. Updated [“Serial Programming Instruction Set”](#) on page 107.
3. Updated [“Speed Grades”](#) on page 117
4. Updated [“Ordering Information”](#) on page 11

9.7 2535C-02/04

1. C-code examples updated to use legal IAR syntax.
2. Replaced occurrences of WDIF with WDTIF and WDIE with WDTIE.
3. Updated [“Stack Pointer”](#) on page 11.
4. Updated [“Calibrated Internal 4.8/9.6 MHz Oscillator”](#) on page 25.
5. Updated [“OSCCAL – Oscillator Calibration Register”](#) on page 27.
6. Updated typo in introduction on [“Watchdog Timer”](#) on page 37.
7. Updated [“ADC Conversion Time”](#) on page 86.
8. Updated [“Serial Programming”](#) on page 105.
9. Updated [“Electrical Characteristics”](#) on page 115.
10. Updated [“Ordering Information”](#) on page 11.
11. Removed rev. C from [“Errata”](#) on page 17.

9.8 Rev. 2535B-01/04

1. Updated [Figure 2-1](#) on page 4.
2. Updated [Table 7-1](#) on page 30, [Table 8-1](#) on page 42, [Table 14-2](#) on page 91 and [Table 18-3](#) on page 118.
3. Updated [“Calibrated Internal 4.8/9.6 MHz Oscillator”](#) on page 25.
4. Updated the whole [“Watchdog Timer”](#) on page 37.
5. Updated [Figure 17-1](#) on page 105 and [Figure 17-2](#) on page 108.
6. Updated registers [“MCUCR – MCU Control Register”](#) on page 56, [“TCCR0B – Timer/Counter Control Register B”](#) on page 72 and [“DIDR0 – Digital Input Disable Register 0”](#) on page 80.
7. Updated Absolute Maximum Ratings and DC Characteristics in [“Electrical Characteristics”](#) on page 115.
8. Added [“Speed Grades”](#) on page 117
9. Updated [“”](#) on page 120.
10. Updated [“Typical Characteristics”](#) on page 123.
11. Updated [“Ordering Information”](#) on page 11.
12. Updated [“Packaging Information”](#) on page 12.
13. Updated [“Errata”](#) on page 17.
14. Changed instances of EEAR to EEARL.

9.9 Rev. 2535A-06/03

1. Initial Revision.



Headquarters

Atmel Corporation
2325 Orchard Parkway
San Jose, CA 95131
USA
Tel: 1(408) 441-0311
Fax: 1(408) 487-2600

International

Atmel Asia
Room 1219
Chinachem Golden Plaza
77 Mody Road Tsimshatsui
East Kowloon
Hong Kong
Tel: (852) 2721-9778
Fax: (852) 2722-1369

Atmel Europe
Le Krebs
8, Rue Jean-Pierre Timbaud
BP 309
78054 Saint-Quentin-en-
Yvelines Cedex
France
Tel: (33) 1-30-60-70-00
Fax: (33) 1-30-60-71-11

Atmel Japan
9F, Tonetsu Shinkawa Bldg.
1-24-8 Shinkawa
Chuo-ku, Tokyo 104-0033
Japan
Tel: (81) 3-3523-3551
Fax: (81) 3-3523-7581

Product Contact

Web Site
www.atmel.com

Technical Support
avr@atmel.com

Sales Contact
www.atmel.com/contacts

Literature Requests
www.atmel.com/literature

Disclaimer: The information in this document is provided in connection with Atmel products. No license, express or implied, by estoppel or otherwise, to any intellectual property right is granted by this document or in connection with the sale of Atmel products. **EXCEPT AS SET FORTH IN ATMEL'S TERMS AND CONDITIONS OF SALE LOCATED ON ATMEL'S WEB SITE, ATMEL ASSUMES NO LIABILITY WHATSOEVER AND DISCLAIMS ANY EXPRESS, IMPLIED OR STATUTORY WARRANTY RELATING TO ITS PRODUCTS INCLUDING, BUT NOT LIMITED TO, THE IMPLIED WARRANTY OF MERCHANTABILITY, FITNESS FOR A PARTICULAR PURPOSE, OR NON-INFRINGEMENT. IN NO EVENT SHALL ATMEL BE LIABLE FOR ANY DIRECT, INDIRECT, CONSEQUENTIAL, PUNITIVE, SPECIAL OR INCIDENTAL DAMAGES (INCLUDING, WITHOUT LIMITATION, DAMAGES FOR LOSS OF PROFITS, BUSINESS INTERRUPTION, OR LOSS OF INFORMATION) ARISING OUT OF THE USE OR INABILITY TO USE THIS DOCUMENT, EVEN IF ATMEL HAS BEEN ADVISED OF THE POSSIBILITY OF SUCH DAMAGES.** Atmel makes no representations or warranties with respect to the accuracy or completeness of the contents of this document and reserves the right to make changes to specifications and product descriptions at any time without notice. Atmel does not make any commitment to update the information contained herein. Unless specifically provided otherwise, Atmel products are not suitable for, and shall not be used in, automotive applications. Atmel's products are not intended, authorized, or warranted for use as components in applications intended to support or sustain life.

© 2008 Atmel Corporation. All rights reserved. Atmel®, logo and combinations thereof, AVR® and others are registered trademarks or trademarks of Atmel Corporation or its subsidiaries. Other terms and product names may be trademarks of others.