



Surface Mount 1500 Watt Transient Voltage Suppressor

Screening in
reference to
MIL-PRF-19500
available

DESCRIPTION

The MSMCG(J)5.0A through MXLSMCG(J)170A series of 1500 watt high-reliability Transient Voltage Suppressors (TVSs) protects a variety of voltage-sensitive components. The SMCG gull-wing design in the DO-215AB package allows for visible solder connections. The SMCJ J-bend design in the DO-214AB package allows for greater PC board mounting density. Selections include unidirectional and bidirectional as well as RoHS compliant versions. These are available with a variety of upscreening options for enhanced reliability. They can protect against the secondary effects of lightning per IEC61000-4-5 and against voltage pulses from inductive switching environments and induced by RF radiation. Since their response time is virtually instantaneous, they can also be used in protection from ESD and EFT per IEC61000-4-2 and IEC61000-4-4.

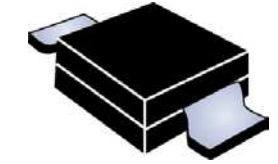

**DO-215AB
(SMCG) Package**

Important: For the latest information, visit our website <http://www.microsemi.com>.

FEATURES

- High reliability devices with fabrication and assembly lot traceability.
- All devices are 100% surge tested.
- 3 σ lot norm screening performed on standby current (I_D).
- Available in both unidirectional and bidirectional versions.
- Moisture classification is "Level 1" with no dry pack required per IPC/JEDEC J-STD-020B.
- Enhanced reliability screening options are available in reference to MIL-PRF-19500. Refer to [High Reliability Up-Screened Plastic Products Portfolio](#) for more details on the screening options. (See [part nomenclature](#) for all available options).
- RoHS compliant versions available.
- Axial-lead equivalent packages for thru-hole mounting are available as 1.5KE6.8A to 1.5KE200CA or 1N6267 thru 1N6303A and 1N5908 (contact Microsemi for other surface mount options).



**DO-214AB
(SMCJ) Package**

NOTE: All SMC series are equivalent to prior SMM package identifications.

Also available:

Commercial grade

 [SMCG\(J\)5.0A - SMCJ\(J\)170CAe3](#)

APPLICATIONS / BENEFITS

- High-reliability devices.
- Selections for 5.0 to 170 volts standoff voltages (V_{WM}).
- Protection from switching transients and induced RF.
- Protection from ESD, and EFT per IEC 61000-4-2 and IEC 61000-4-4.
- Secondary lightning protection per IEC61000-4-5 with 42 ohms source impedance:
 - Class 1: MSMC 5.0A to MXLSMC 170A or CA
 - Class 2: MSMC 5.0A to MXLSMC 150A or CA
 - Class 3: MSMC 5.0A to MXLSMC 75A or CA
 - Class 4: MSMC 5.0A to MXLSMC 36A or CA
- Secondary lightning protection per IEC61000-4-5 with 12 ohms source impedance:
 - Class 1: MSMC 5.0A to MXLSMC 90A or CA
 - Class 2: MSMC 5.0A to MXLSMC 45A or CA
 - Class 3: MSMC 5.0A to MXLSMC 24A or CA
 - Class 4: MSMC 5.0A to MXLSMC 11A or CA
- Secondary lightning protection per IEC61000-4-5 with 2 ohms source impedance:
 - Class 2: MSMC 5.0A to MXLSMC 22A or CA
 - Class 3: MSMC 5.0A to MXLSMC 10A or CA

MSC – Lawrence

6 Lake Street,
Lawrence, MA 01841
Tel: 1-800-446-1158 or
(978) 620-2600
Fax: (978) 689-0803

MSC – Ireland

Gort Road Business Park,
Ennis, Co. Clare, Ireland
Tel: +353 (0) 65 6840044
Fax: +353 (0) 65 6822298

Website:

www.microsemi.com

MAXIMUM RATINGS

Parameters/Test Conditions	Symbol	Value	Unit	
Junction and Storage Temperature	T _J and T _{STG}	-65 to +150	°C	
Thermal Resistance Junction-to-Lead	R _{θJL}	20	°C/W	
Thermal Resistance Junction-to-Ambient ⁽¹⁾	R _{θJA}	80	°C/W	
Peak Pulse Power Dissipation @ 25 °C (at 10/1000 μs, see Figures 1, 2, and 3)	P _{PP}	1500	W	
Impulse Repetition Rate (duty factor)	df	0.01	%	
t _{clamping} (0 volts to V _(BR) min.)	Unidirectional Bidirectional	t _{clamping}	<100 <5	ps ns
Rated Average Power Dissipation	T _L = +30 °C T _A = +25 °C	P _{M(AV)}	6 1.56 ⁽¹⁾	W
Maximum Forward Surge Current ⁽²⁾		I _{FSM}	200	A (pk)
Solder Temperature @ 10 s		T _{SP}	260	°C

- Notes:** 1. When mounted on FR4 PC board (1oz Cu) with recommended footprint (see [last page](#)).
2. Peak impulse of 8.3 ms half-sine wave at 25 °C (unidirectional only).

MECHANICAL and PACKAGING

- CASE: Void-free transfer molded thermosetting epoxy body meeting UL94V-0.
- TERMINALS: Tin-lead or RoHS compliant annealed matte-tin plating. Solderable to MIL-STD-750, method 2026.
- MARKING: Part number marked on package.
- POLARITY: Cathode indicated by band. No cathode band on bi-directional devices.
- TAPE & REEL option: Standard per EIA-481-2 with 16 mm tape (add "TR" suffix to part number). Consult factory for quantities.
- WEIGHT: Approximately 0.25 grams.
- See [Package Dimensions](#) on last page.

PART NOMENCLATURE

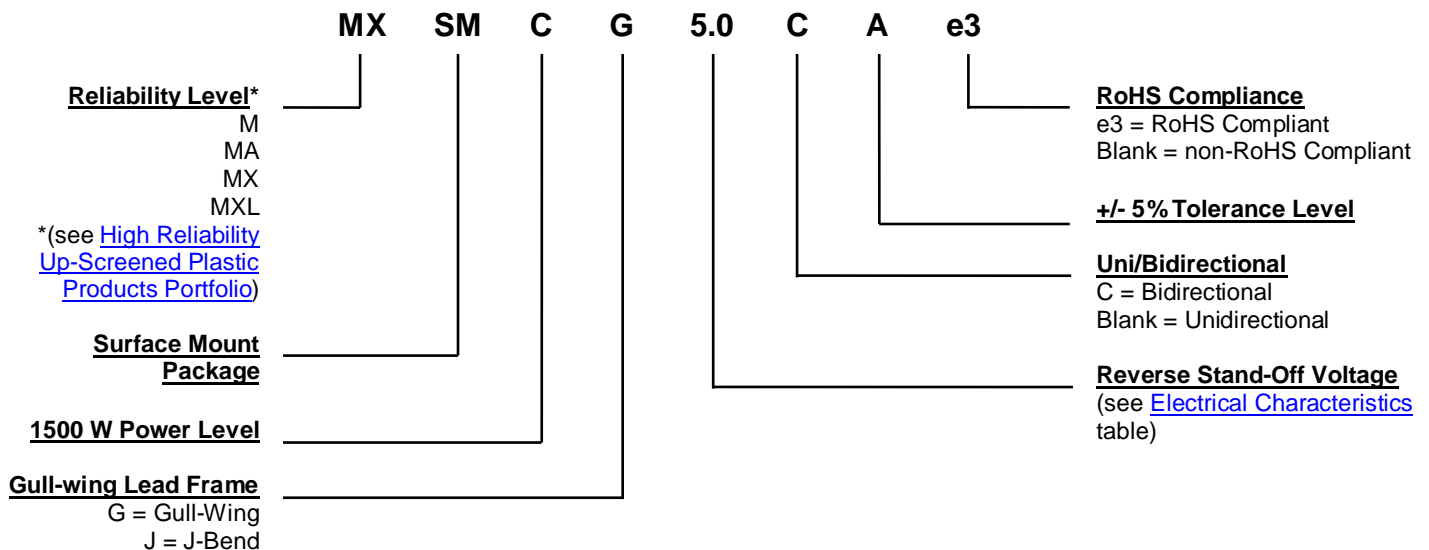

SYMBOLS & DEFINITIONS

Symbol	Definition
$I_{(BR)}$	Breakdown Current: The current used for measuring breakdown voltage $V_{(BR)}$.
I_D	Standby Current: The current at the rated standoff voltage (V_{WM}).
I_F	Forward Current: The forward current dc value, no alternating component.
I_O	Average Rectified Output Current: The output current averaged over a full cycle with a 50 Hz or 60 Hz sine-wave input and a 180 degree conduction angle.
I_{PP}	Peak Impulse Current: The peak current during the impulse.
P_{PP}	Peak Pulse Power: The peak power dissipation resulting from the peak impulse current I_{PP} .
V_C	Clamping Voltage: Maximum clamping voltage at specified I_{PP} (Peak Pulse Current) at the specified pulse conditions.
$V_{(BR)}$	Minimum Breakdown Voltage: The minimum voltage the device will exhibit at a specified current.
V_{WM}	Working Peak Voltage: The maximum peak voltage that can be applied over the operating temperature range. This is also referred to as standoff voltage.

ELECTRICAL CHARACTERISTICS @ 25 °C unless otherwise stated

MICROSEMI PART NUMBER		REVERSE STAND-OFF VOLTAGE V_{WM} Volts	BREAKDOWN VOLTAGE $V_{(BR)}$ @ $I_{(BR)}$ Volts		MAXIMUM CLAMPING VOLTAGE @ I_{PP} Volts	PEAK PULSE CURRENT (See Fig. 2) I_{PP} Amps	MAXIMUM STANDBY CURRENT @ V_{WM} I_D μA
Gull-Wing	J-Bend		MIN.	MAX.			
MSMCG5.0A	MSMCJ5.0A	5.0	6.40 – 7.00	10	9.2	163.0	1000
MSMCG6.0A	MSMCJ6.0A	6.0	6.67 – 7.37	10	10.3	145.6	1000
MSMCG6.5A	MSMCJ6.5A	6.5	7.22 – 7.98	10	11.2	133.9	500
MSMCG7.0A	MSMCJ7.0A	7.0	7.78 – 8.60	10	12.0	125.0	200
MSMCG7.5A	MSMCJ7.5A	7.5	8.33 – 9.21	1	12.9	116.3	100
MSMCG8.0A	MSMCJ8.0A	8.0	8.89 – 9.83	1	13.6	110.3	50
MSMCG8.5A	MSMCJ8.5A	8.5	9.44 – 10.4	1	14.4	104.2	20
MSMCG9.0A	MSMCJ9.0A	9.0	10.0 – 11.1	1	15.4	97.4	10
MSMCG10A	MSMCJ10A	10	11.1 – 12.3	1	17.0	88.2	5
MSMCG11A	MSMCJ11A	11	12.2 – 13.5	1	18.2	82.4	5
MSMCG12A	MSMCJ12A	12	13.3 – 14.7	1	19.9	75.3	5
MSMCG13A	MSMCJ13A	13	14.4 – 15.9	1	21.5	69.7	1
MSMCG14A	MSMCJ14A	14	15.6 – 17.2	1	23.2	64.7	1
MSMCG15A	MSMCJ15A	15	16.7 – 18.5	1	24.4	61.5	1
MSMCG16A	MSMCJ16A	16	17.8 – 19.7	1	26.0	57.7	1
MSMCG17A	MSMCJ17A	17	18.9 – 20.9	1	27.6	53.3	1
MSMCG18A	MSMCJ18A	18	20.0 – 22.1	1	29.2	51.4	1
MSMCG20A	MSMCJ20A	20	22.2 – 24.5	1	32.4	46.3	1
MSMCG22A	MSMCJ22A	22	24.4 – 26.9	1	35.5	42.2	1
MSMCG24A	MSMCJ24A	24	26.7 – 29.5	1	38.9	38.6	1
MSMCG26A	MSMCJ26A	26	28.9 – 31.9	1	42.1	35.6	1
MSMCG28A	MSMCJ28A	28	31.1 – 34.4	1	45.4	33.0	1
MSMCG30A	MSMCJ30A	30	33.3 – 36.8	1	48.4	31.0	1
MSMCG33A	MSMCJ33A	33	36.7 – 40.6	1	53.3	28.1	1
MSMCG36A	MSMCJ36A	36	40.0 – 44.2	1	58.1	25.8	1
MSMCG40A	MSMCJ40A	40	44.4 – 49.1	1	64.5	23.2	1
MSMCG43A	MSMCJ43A	43	47.8 – 52.8	1	69.4	21.6	1
MSMCG45A	MSMCJ45A	45	50.0 – 55.3	1	72.7	20.6	1
MSMCG48A	MSMCJ48A	48	53.3 – 58.9	1	77.4	19.4	1
MSMCG51A	MSMCJ51A	51	56.7 – 62.7	1	82.4	18.2	1
MSMCG54A	MSMCJ54A	54	60.0 – 66.3	1	87.1	17.2	1
MSMCG58A	MSMCJ58A	58	64.4 – 71.2	1	93.6	16.0	1
MSMCG60A	MSMCJ60A	60	66.7 – 73.7	1	96.8	15.5	1
MSMCG64A	MSMCJ64A	64	71.1 – 78.6	1	103.0	14.6	1
MSMCG70A	MSMCJ70A	70	77.8 – 86.0	1	113	13.3	1
MSMCG75A	MSMCJ75A	75	83.3 – 92.1	1	121	12.4	1

Continued.

ELECTRICAL CHARACTERISTICS @ 25 °C unless otherwise stated (continued)

MICROSEMI PART NUMBER		REVERSE STAND-OFF VOLTAGE V_{WM} Volts	BREAKDOWN VOLTAGE $V_{(BR)}$ @ $I_{(BR)}$ Volts		MAXIMUM CLAMPING VOLTAGE @ I_{PP} Volts	PEAK PULSE CURRENT (See Fig. 2) I_{PP} Amps	MAXIMUM STANDBY CURRENT @ V_{WM} I_D μA
Gull-Wing	J-Bend		MIN.	MAX.			
MSMCG78A	MSMCJ78A	78	86.7 – 95.8	1	126	11.4	1
MSMCG85A	MSMCJ85A	85	94.4 – 104.0	1	137	10.4	1
MSMCG90A	MSMCJ90A	90	100 – 111	1	146	10.3	1
MSMCG100A	MSMCJ100A	100	111 – 123	1	162	9.3	1
MSMCG110A	MSMCJ110A	110	122 – 135	1	177	8.4	1
MSMCG120A	MSMCJ120A	120	133 – 147	1	193	7.8	1
MSMCG130A	MSMCJ130A	130	144 – 159	1	209	7.2	1
MSMCG150A	MSMCJ150A	150	167 – 185	1	243	6.2	1
MSMCG160A	MSMCJ160A	160	178 – 197	1	259	5.8	1
MSMCG170A	MSMCJ170A	170	189 – 209	1	275	5.5	1

GRAPHS

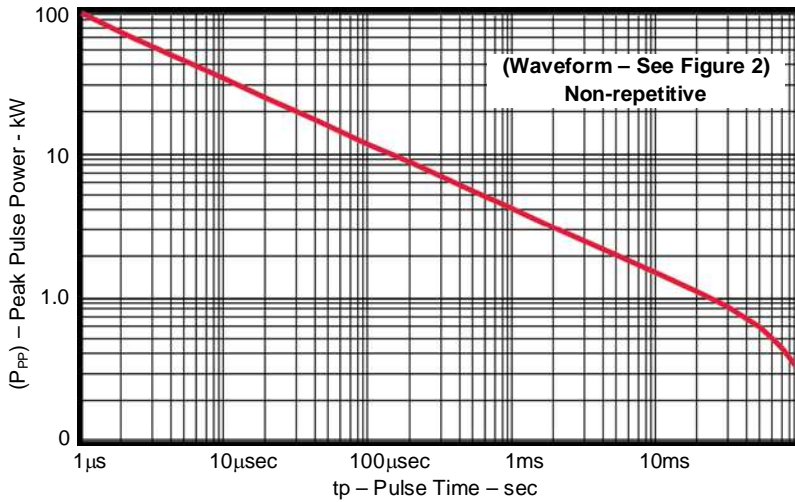

FIGURE 1 – Peak Pulse Power vs. Pulse Time

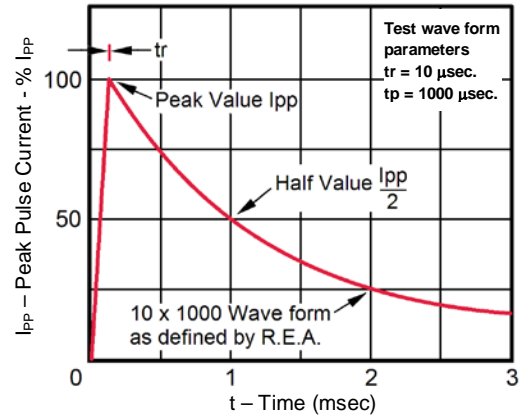

FIGURE 2 – Pulse Waveform



FIGURE 3 – Derating Curve

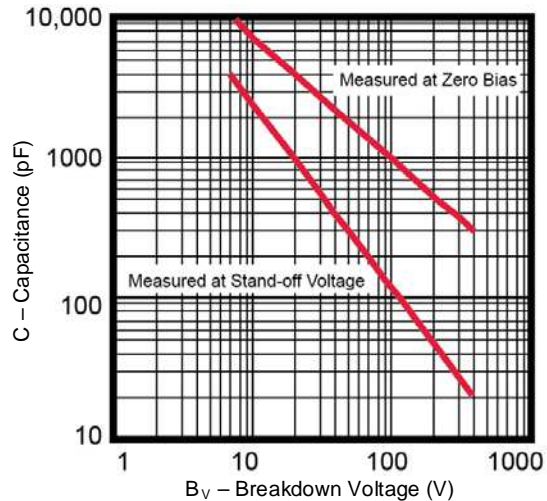
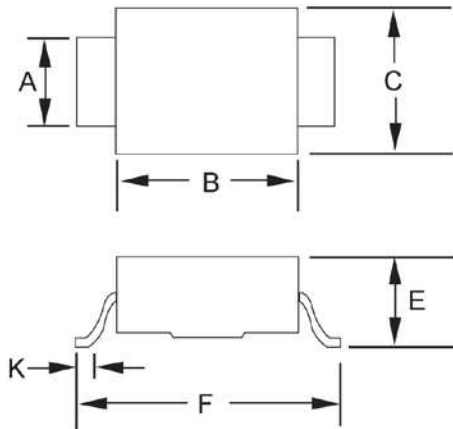
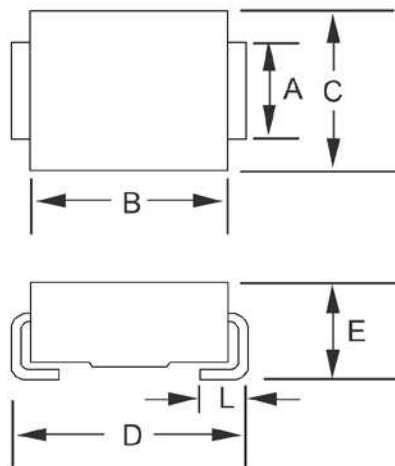

FIGURE 4
Typical Capacitance vs.
Breakdown Voltage (unidirectional configuration)
NOTE: Bidirectional capacitance is half that shown at zero volts.

PACKAGE DIMENSIONS

SMCG (DO-215AB)

Ltr	Dimensions			
	Inch		Millimeters	
	Min	Max	Min	Max
A	.115	.121	2.92	3.07
B	.260	.280	6.60	7.11
C	.220	.245	5.59	6.22
E	.077	.110	1.95	2.80
F	.380	.400	9.65	10.16
K	.025	.040	0.635	1.016

NOTES: Dimension "E" exceeds the JEDEC outline as shown.
Typical Standoff Height: 0.004" – 0.008" (0.1 mm – 0.2 mm).

SMCJ (DO-214AB)

Ltr	Dimensions			
	Inch		Millimeters	
	Min	Max	Min	Max
A	.115	.121	2.92	3.07
B	.260	.280	6.60	7.11
C	.220	.245	5.59	6.22
D	.305	.320	7.75	8.13
E	.077	.110	1.95	2.80
L	.030	.060	.760	1.52

NOTES: Dimension "E" exceeds the JEDEC outline in height as shown.
Typical Standoff Height: 0.004" – 0.008" (0.1 mm – 0.2 mm).

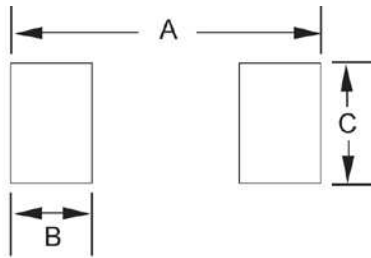
PAD LAYOUT

SMCG (DO-215AB)		
Ltr	Inch	Millimeters
A	.510	12.95
B	.110	2.79
C	.150	3.81

SMCJ (DO-214AB)		
Ltr	Inch	Millimeters
A	.390	9.90
B	.110	2.79
C	.150	3.81