

Medium-High Voltage MLCC for Automotive / Industrial Applications

HMK316B7154KLHT

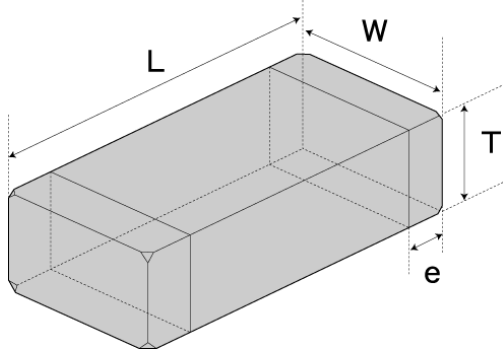

■ Features

- Item Summary
100V, X7R, 0.15 μ F, \pm 10%, 1206
- Lifecycle Stage
Mass Production
- AEC-Q200 qualified
- Standard packaging quantity (minimum)
Taping Embossed 2000pcs

■ Products characteristics table

CaseSize (EIA/JIS)	1206/3216
Rated Voltage (max)	100V
Capacitance	0.15 μ F
Capacitance Tolerance	\pm 10%
Resistance	100 M Ω · μ F min.
Dielectric Loss Tangent	3.5%MAX
Temperature Characteristics (EIA/JIS)	X7R/-
Temperature Range (EIA/JIS)	-55 to +125 $^{\circ}$ C/-
Capacitance Change (EIA/JIS)	\pm 15/-%
RoHS Compliance	Yes
Halogen Free	Yes
Soldering Method	Reflow

■ External Dimensions

L	3.2mm \pm 0.15
W	1.6mm \pm 0.15
T	1.6mm \pm 0.20
e	0.5mm +0.35:-0.25

2015.02.03

The data is reference only. Electrical characteristics vary depending on environment or measurement condition.
 TAIYO YUDEN reserves the right to make change to the Date at any time without notice.
 Before making final selection, please check product specification.

Multi Layer Ceramic Capacitor **TAIYO YUDEN**

-Electrical Characteristics Data-

13QA01

RoHS compliance product

○HMK316B7154KLHT

100V 3216 X7R 0.15uF +/- 10% t=1.8mmMAX
100V 1206 X7R 0.15uF +/- 10% t=0.07inchMAX

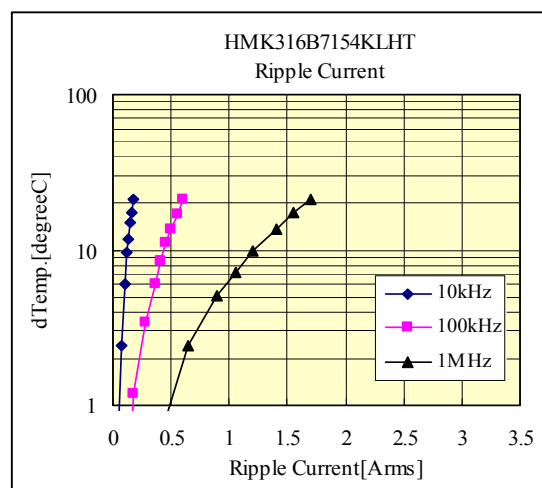
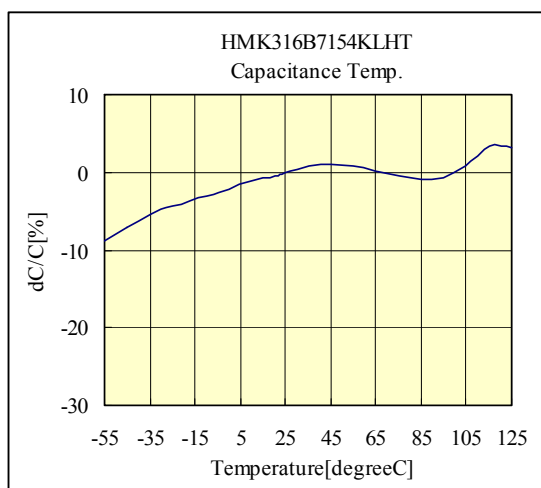
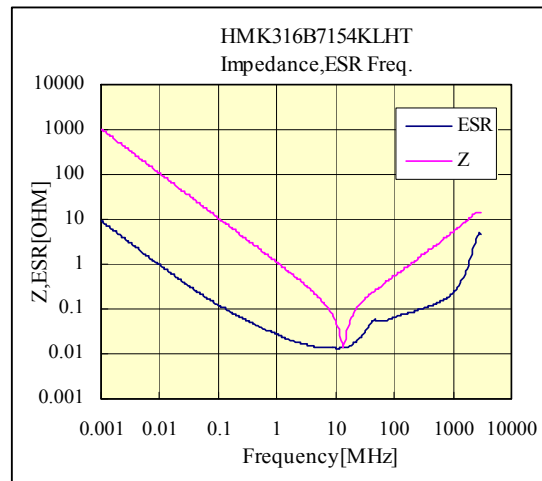
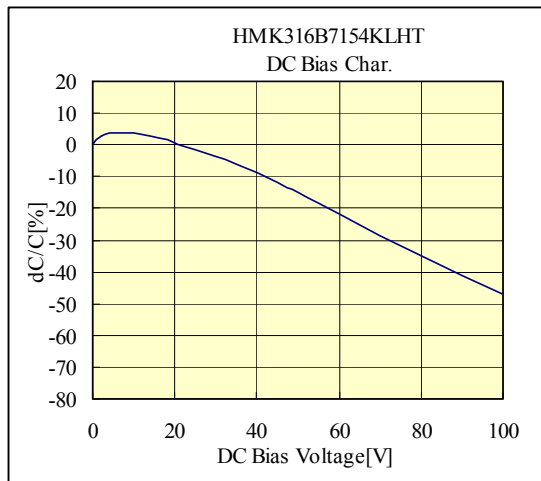
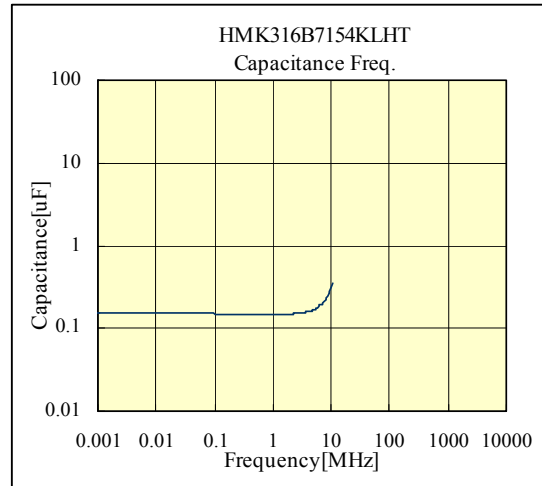
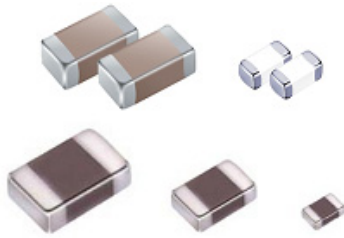

部品特性は設置環境、測定条件等により変化する場合があります。本データをご使用される際は実際の製品特性に対する参考データとしてご利用ください。また、本データは予告無く追加・削除及び変更を行う場合があります。ご注文の際は、納入仕様書のご確認をお願いします。

The data is reference only. Electrical characteristics vary depending on environment or measurement condition.

TAIYO YUDEN reserves the right to make change to the Date at any time without notice.

Before making final selection, please check product specification