



BAV100 thru BAV103

Small-Signal Diode
Fast Switching Diodes

Features

- ◆ Silicon Epitaxial Planar Diodes
- ◆ For general purpose
- ◆ These diodes are also available in other case styles including: the DO-35 case with the type designations BAV19 to BAV21.

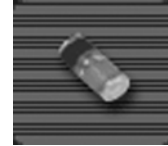

Mechanical Data

- ◆ Case: MiniMELF Glass Case (SOD-80)
- ◆ Weight: approx. 0.05g
- ◆ Cathode Band Color: Yellow

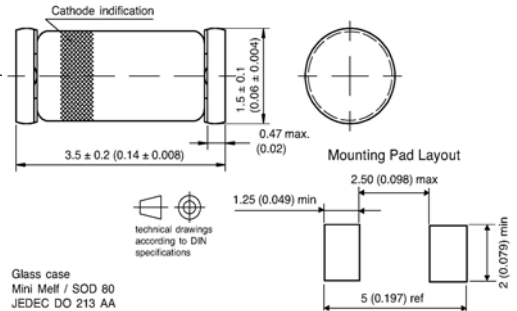

Maximum Ratings and Thermal Characteristics

($T_A=25^\circ\text{C}$ unless otherwise noted.)

Parameter	Symbol	Limit	Unit	
Continuous reverse voltage	BAV100 BAV101 BAV102 BAV103	V_R	50 100 150 200	Volts
Repetitive peak reverse voltage	BAV100 BAV101 BAV102 BAV103	V_{RRM}	60 120 200 250	Volts
Forward DC current at $T_{amb}=25^\circ\text{C}$ ⁽¹⁾		I_F	250	mA
Rectified current (Average) half wave rectification with resist. load at $T_{amb}=25^\circ\text{C}$ and $f_{\geq 50\text{Hz}}$ ⁽¹⁾		$I_{F(AV)}$	200	mA
Repetitive peak forward current at $f_{\geq 50\text{Hz}}$, $\Theta=180^\circ$, $T_{amb}=25^\circ\text{C}$ ⁽¹⁾		I_{FRM}	625	mA
Surge forward current at $t < 1\text{s}$ and $T_A=25^\circ\text{C}$		I_{FSM}	1.0	Amp
Power dissipation at $T_{amb}=25^\circ\text{C}$ ⁽¹⁾		P_{tot}	400	mW
Thermal resistance junction to ambient air ⁽¹⁾		$R_{\theta JA}$	375	$^\circ\text{C/W}$
Junction temperature		T_J	175	$^\circ\text{C}$
Storage temperature range ⁽¹⁾		T_S	-65 to +175	$^\circ\text{C}$

Notes: 1. Valid provided that electrodes are kept at ambient temperature

Electrical Characteristics

($T_J=25^\circ\text{C}$ unless otherwise noted.)

Parameter	Symbol	Test Condition	Min.	Typ.	Max.	Unit
Forward voltage	V_F	$I_F=100\text{mA}$ $I_F=200\text{mA}$	-	-	1.00 1.25	Volts
Leakage current	I_R	$V_R=50\text{V}$	-	-	100	nA
		$V_R=50\text{V}, T_J=100^\circ\text{C}$	-	-	15	μA
		$V_R=100\text{V}$	-	-	100	nA
		$V_R=100\text{V}, T_J=100^\circ\text{C}$	-	-	15	μA
		$V_R=150\text{V}$	-	-	100	nA
		$V_R=150\text{V}, T_J=100^\circ\text{C}$	-	-	15	μA
		$V_R=200\text{V}$	-	-	100	nA
$V_R=200\text{V}, T_J=100^\circ\text{C}$	-	-	15	μA		
Dynamic forward resistance	r_f	$I_F=10\text{mA}$	-	5	-	Ω
Capacitance	C_{tot}	$V_R=0\text{V}, f=1\text{MHz}$	-	1.5	-	pF
Reverse recovery time	t_{rr}	$I_F=30\text{mA}, I_R=30\text{mA}$ $I_F=3\text{mA}, R_L=100\Omega$	-	-	50	nS

RATINGS AND CHARACTERISTIC CURVES

($T_A = 25^\circ\text{C}$ unless otherwise noted.)

Forward characteristics

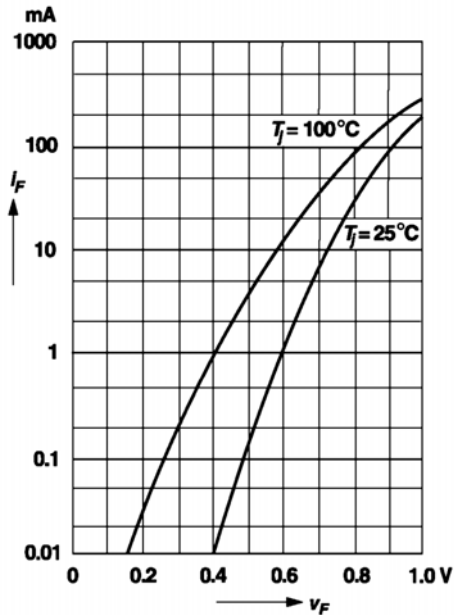

Admissible forward current versus ambient temperature

Valid provided that electrodes are kept at ambient temperature

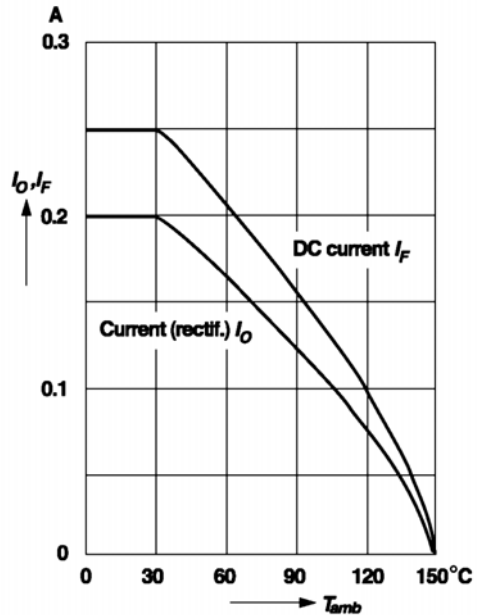

RATINGS AND CHARACTERISTIC CURVES

($T_A = 25^\circ\text{C}$ unless otherwise noted.)

Admissible power dissipation versus ambient temperature

Valid provided that electrodes are kept at ambient temperature

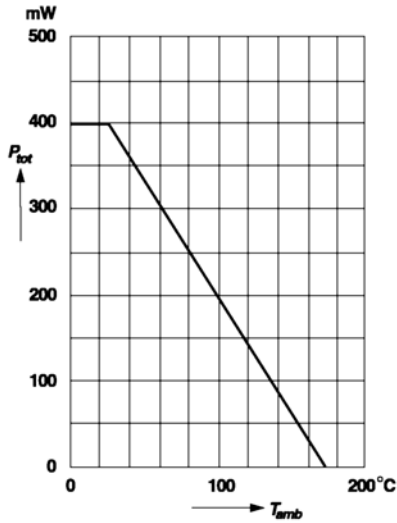

Leakage current versus junction temperature

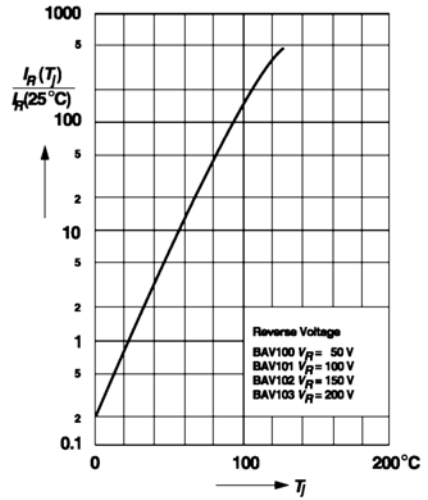

Dynamic forward resistance versus forward current

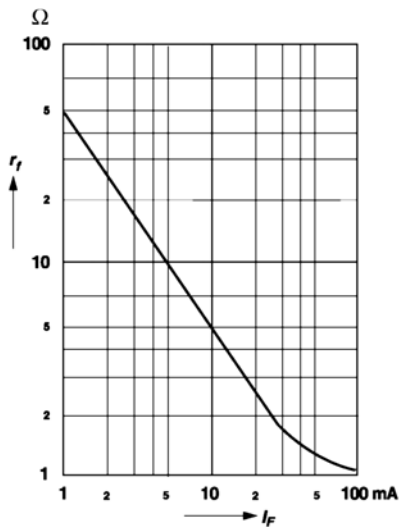

Capacitance versus reverse voltage

