

## Trench gate field-stop IGBT M series, 650 V 15 A low loss

Datasheet - preliminary data

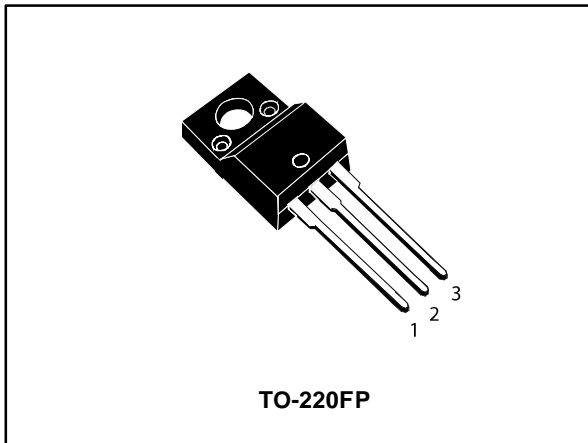
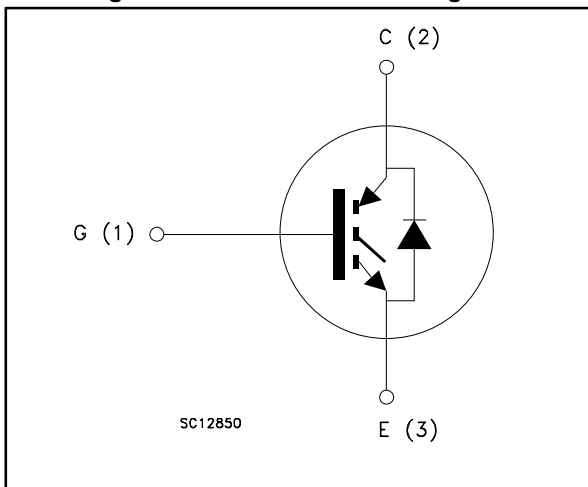

Figure 1: Internal schematic diagram



### Features

- 6  $\mu$ s of short-circuit withstand time
- $V_{CE(sat)} = 1.55$  V (typ.) @  $I_C = 15$  A
- Tight parameter distribution
- Safer paralleling
- Low thermal resistance
- Soft and very fast recovery antiparallel diode

### Applications

- Motor control
- UPS
- PFC

### Description

This device is an IGBT developed using an advanced proprietary trench gate field-stop structure. The device is part of the M series of IGBTs, which represents an optimum compromise in performance to maximize the efficiency of inverter systems where low loss and short-circuit capability are essential. Furthermore, a positive  $V_{CE(sat)}$  temperature coefficient and tight parameter distribution result in safer paralleling operation.

Table 1: Device summary

Order code	Marking	Package	Packing
STGF15M65DF2	G15M65DF2	TO-220FP	Tube

---

## Contents

<b>1</b>	<b>Electrical ratings .....</b>	<b>3</b>
<b>2</b>	<b>Electrical characteristics .....</b>	<b>4</b>
	2.1 Electrical characteristics (curves).....	6
<b>3</b>	<b>Test circuits .....</b>	<b>11</b>
<b>4</b>	<b>Package information .....</b>	<b>12</b>
	4.1 TO-220FP package information .....	12
<b>5</b>	<b>Revision history .....</b>	<b>14</b>

# 1 Electrical ratings

**Table 2: Absolute maximum ratings**

Symbol	Parameter	Value	Unit
$V_{CES}$	Collector-emitter voltage ( $V_{GE} = 0$ V)	650	V
$I_C^{(1)}$	Continuous collector current at $T_C = 25$ °C	30	A
	Continuous collector current at $T_C = 100$ °C	15	
$I_{CP}^{(2)}$	Pulsed collector current	60	A
$V_{GE}$	Gate-emitter voltage	±20	V
$I_F^{(1)}$	Continuous forward current at $T_C = 25$ °C	30	A
	Continuous forward current at $T_C = 100$ °C	15	
$I_{FP}^{(2)}$	Pulsed forward current	60	A
$V_{ISO}$	Insulation withstand voltage (RMS) from all three leads to external heat sink ( $t = 1$ s, $T_C = 25$ °C)	2.5	kV
$P_{TOT}$	Total dissipation at $T_C = 25$ °C	31	W
$T_{STG}$	Storage temperature range	- 55 to 150	°C
$T_J$	Operating junction temperature	- 55 to 175	°C

**Notes:**

<sup>(1)</sup>Limited by maximum junction temperature.

<sup>(2)</sup>Pulse width limited by maximum junction temperature.

**Table 3: Thermal data**

Symbol	Parameter	Value	Unit
$R_{thJC}$	Thermal resistance junction-case IGBT	4.8	°C/W
$R_{thJC}$	Thermal resistance junction-case diode	6.25	
$R_{thJA}$	Thermal resistance junction-ambient	62.5	

## 2 Electrical characteristics

$T_C = 25\text{ °C}$  unless otherwise specified

**Table 4: Static characteristics**

Symbol	Parameter	Test conditions	Min.	Typ.	Max.	Unit
$V_{(BR)CES}$	Collector-emitter breakdown voltage	$V_{GE} = 0\text{ V}$ , $I_C = 2\text{ mA}$	650			V
$V_{CE(sat)}$	Collector-emitter saturation voltage	$V_{GE} = 15\text{ V}$ , $I_C = 15\text{ A}$		1.55	2.0	V
		$V_{GE} = 15\text{ V}$ , $I_C = 15\text{ A}$ , $T_J = 125\text{ °C}$		1.9		
		$V_{GE} = 15\text{ V}$ , $I_C = 15\text{ A}$ , $T_J = 175\text{ °C}$		2.1		
$V_F$	Forward on-voltage	$I_F = 15\text{ A}$		1.7		V
		$I_F = 15\text{ A}$ , $T_J = 125\text{ °C}$		1.5		
		$I_F = 15\text{ A}$ , $T_J = 175\text{ °C}$		1.4		
$V_{GE(th)}$	Gate threshold voltage	$V_{CE} = V_{GE}$ , $I_C = 500\text{ }\mu\text{A}$	5	6	7	V
$I_{CES}$	Collector cut-off current	$V_{GE} = 0\text{ V}$ , $V_{CE} = 650\text{ V}$			25	$\mu\text{A}$
$I_{GES}$	Gate-emitter leakage current	$V_{CE} = 0\text{ V}$ , $V_{GE} = \pm 20\text{ V}$			$\pm 250$	$\mu\text{A}$

**Table 5: Dynamic characteristics**

Symbol	Parameter	Test conditions	Min.	Typ.	Max.	Unit
$C_{ies}$	Input capacitance	$V_{CE} = 25\text{ V}$ , $f = 1\text{ MHz}$ , $V_{GE} = 0\text{ V}$	-	1250	-	pF
$C_{oes}$	Output capacitance		-	80	-	
$C_{res}$	Reverse transfer capacitance		-	25	-	
$Q_g$	Total gate charge	$V_{CC} = 520\text{ V}$ , $I_C = 15\text{ A}$ , $V_{GE} = 15\text{ V}$ (see <a href="#">Figure 30: "Gate charge test circuit"</a> )	-	45	-	nC
$Q_{ge}$	Gate-emitter charge		-	11	-	
$Q_{gc}$	Gate-collector charge		-	15	-	

Table 6: IGBT switching characteristics (inductive load)

Symbol	Parameter	Test conditions	Min.	Typ.	Max.	Unit
$t_{d(on)}$	Turn-on delay time	$V_{CE} = 400\text{ V}$ , $I_C = 15\text{ A}$ , $V_{GE} = 15\text{ V}$ , $R_G = 12\ \Omega$ (see <a href="#">Figure 29: "Test circuit for inductive load switching"</a> )		24	-	ns
$t_r$	Current rise time			7.8	-	ns
$(di/dt)_{on}$	Turn-on current slope			1570	-	A/ $\mu$ s
$t_{d(off)}$	Turn-off-delay time			93	-	ns
$t_f$	Current fall time			106	-	ns
$E_{on}^{(1)}$	Turn-on switching losses			0.09	-	mJ
$E_{off}^{(2)}$	Turn-off switching losses			0.45	-	mJ
$E_{ts}$	Total switching losses			0.54	-	mJ
$t_{d(on)}$	Turn-on delay time	$V_{CE} = 400\text{ V}$ , $I_C = 15\text{ A}$ , $V_{GE} = 15\text{ V}$ , $R_G = 12\ \Omega$ $T_J = 175\text{ }^\circ\text{C}$ (see <a href="#">Figure 29: "Test circuit for inductive load switching"</a> )		24.8	-	ns
$t_r$	Current rise time			9.2	-	ns
$(di/dt)_{on}$	Turn-on current slope			1300	-	A/ $\mu$ s
$t_{d(off)}$	Turn-off-delay time			96	-	ns
$t_f$	Current fall time			169	-	ns
$E_{on}$	Turn-on switching losses			0.22	-	mJ
$E_{off}$	Turn-off switching losses			0.61	-	mJ
$E_{ts}$	Total switching losses			0.83	-	mJ
$t_{sc}$	Short-circuit withstand time	$V_{CC} \leq 400\text{ V}$ , $V_{GE} = 15\text{ V}$ , $T_{Jstart} = 150\text{ }^\circ\text{C}$	6		-	$\mu$ s

**Notes:**

(1)Energy losses include reverse recovery of the diode.

(2)Turn-off losses also include the tail of the collector current.

Table 7: Diode switching characteristics (inductive load)

Symbol	Parameter	Test conditions	Min.	Typ.	Max.	Unit
$t_{rr}$	Reverse recovery time	$I_F = 15\text{ A}$ , $V_R = 400\text{ V}$ , $V_{GE} = 15\text{ V}$ (see <a href="#">Figure 29: "Test circuit for inductive load switching"</a> ) $di/dt = 1000\text{ A}/\mu\text{s}$	-	142	-	ns
$Q_{rr}$	Reverse recovery charge		-	525	-	nC
$I_{rrm}$	Reverse recovery current		-	13.4	-	A
$dl_{rr}/dt$	Peak rate of fall of reverse recovery current during $t_b$		-	790	-	A/ $\mu$ s
$E_{rr}$	Reverse recovery energy		-	64	-	$\mu$ J
$t_{rr}$	Reverse recovery time	$I_F = 15\text{ A}$ , $V_R = 400\text{ V}$ , $V_{GE} = 15\text{ V}$ , $T_J = 175\text{ }^\circ\text{C}$ (see <a href="#">Figure 29: "Test circuit for inductive load switching"</a> ) $di/dt = 1000\text{ A}/\mu\text{s}$	-	241	-	ns
$Q_{rr}$	Reverse recovery charge		-	1690	-	nC
$I_{rrm}$	Reverse recovery current		-	20	-	A
$dl_{rr}/dt$	Peak rate of fall of reverse recovery current during $t_b$		-	420	-	A/ $\mu$ s
$E_{rr}$	Reverse recovery energy		-	176	-	$\mu$ J

2.1 Electrical characteristics (curves)

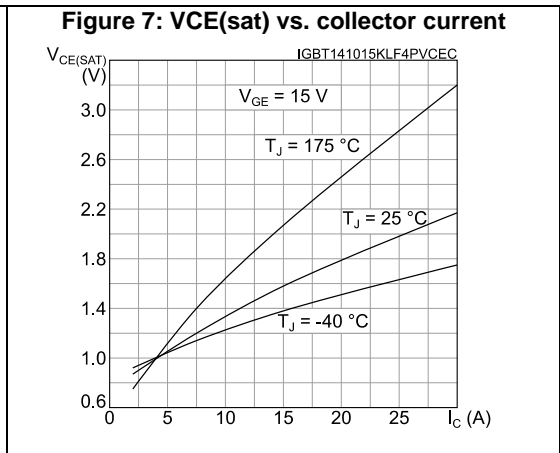
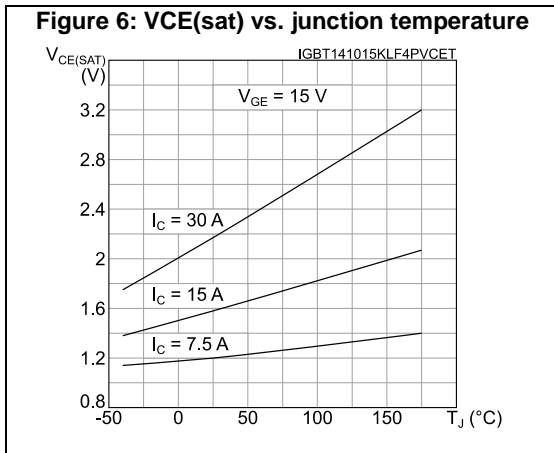
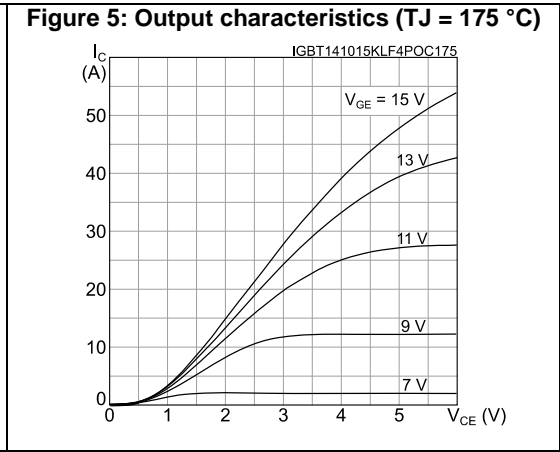
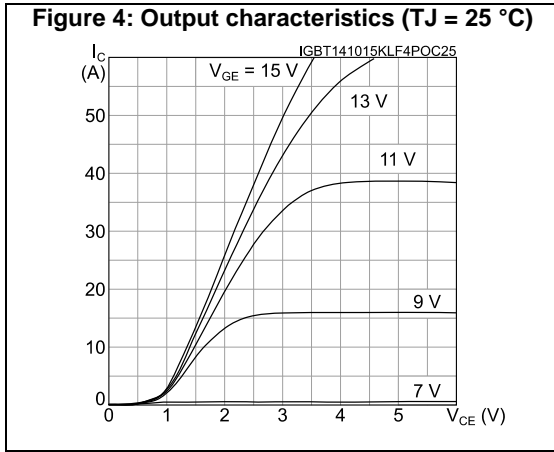
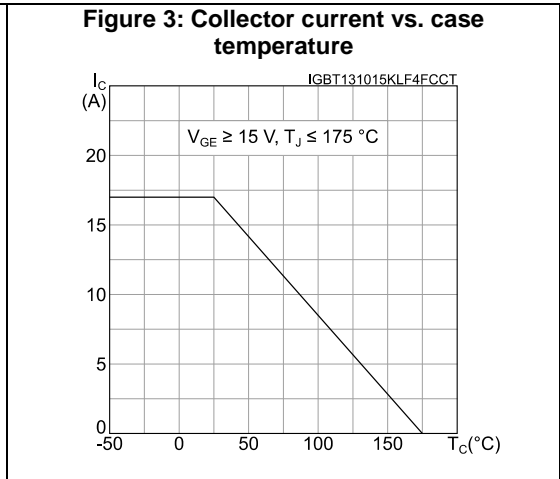
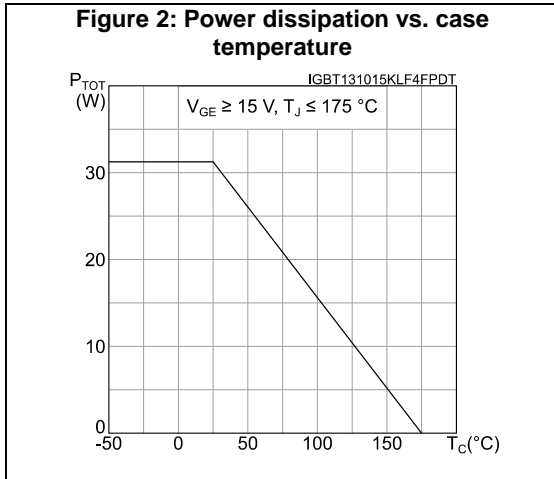

**Figure 8: Collector current vs. switching frequency**

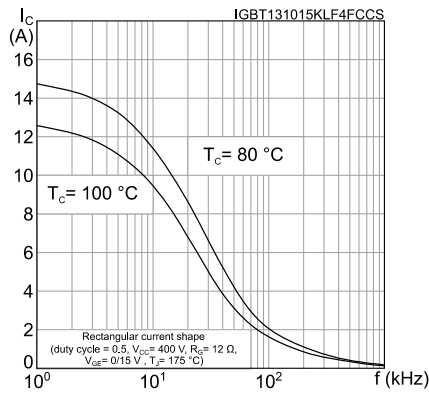

**Figure 9: Forward bias safe operating area**

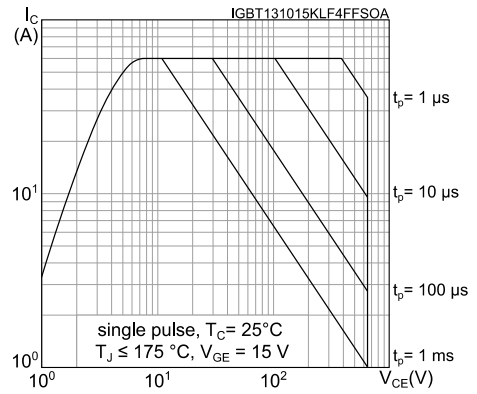

**Figure 10: Transfer characteristics**

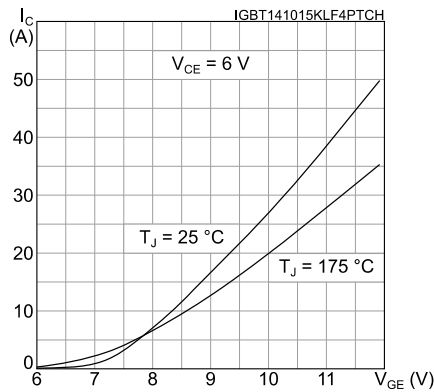

**Figure 11: Diode VF vs. forward current**

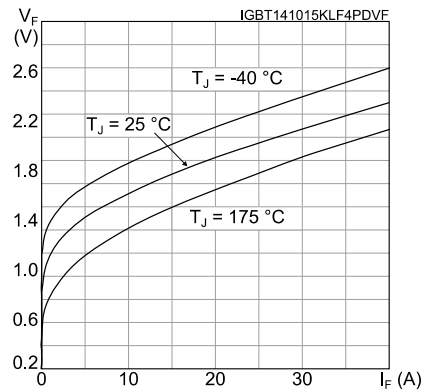

**Figure 12: Normalized V\_GE(th) vs. junction temperature**

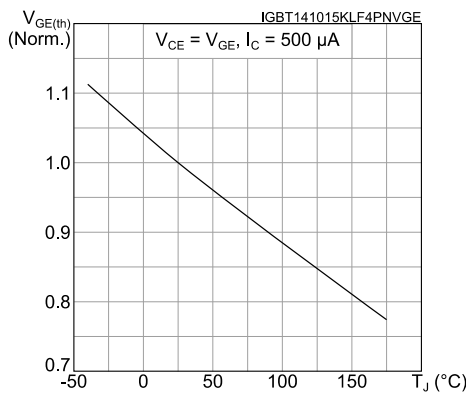

**Figure 13: Normalized V(BR)CES vs. junction temperature**

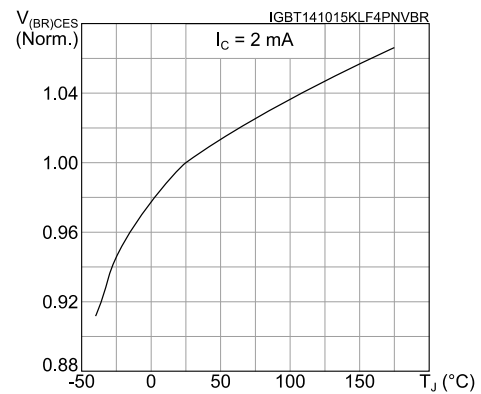

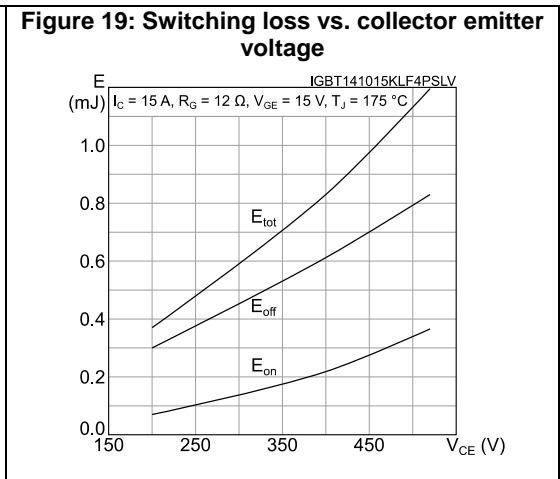
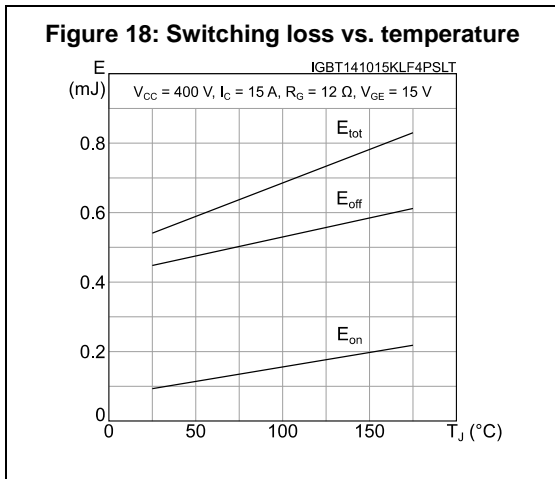
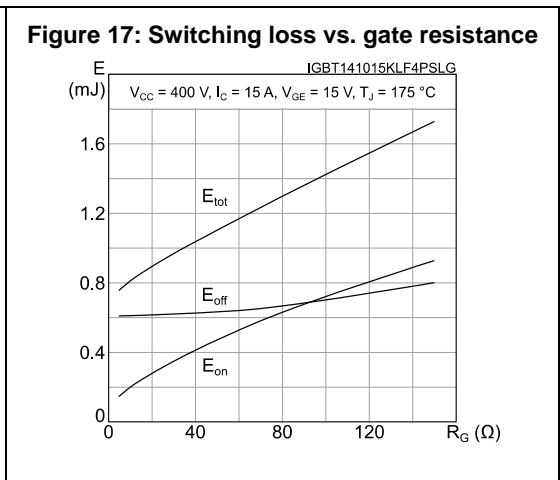
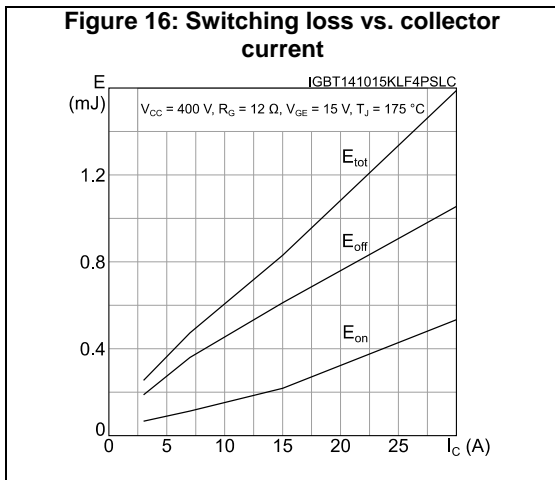
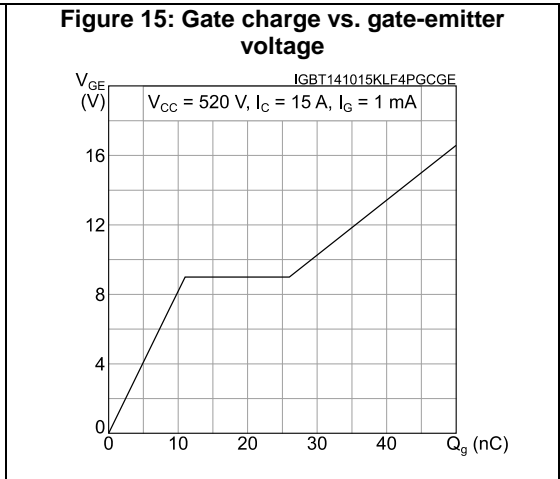
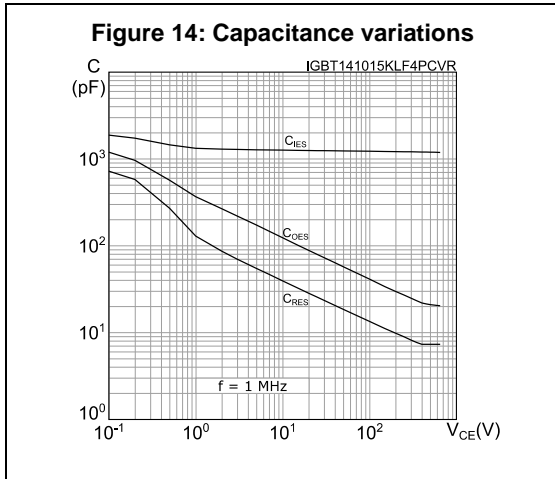



Figure 20: Short-circuit time and current vs. V<sub>GE</sub>

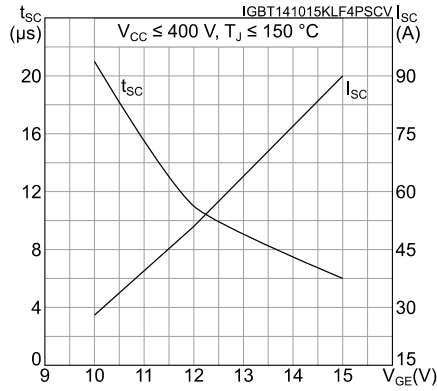

Figure 21: Switching times vs. collector current

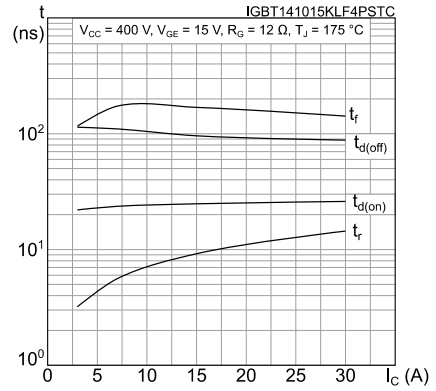

Figure 22: Switching times vs. gate resistance

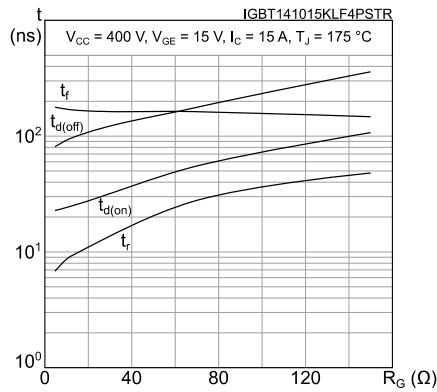

Figure 23: Reverse recovery current vs. diode current slope

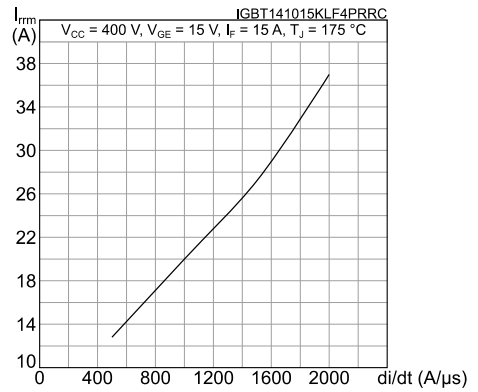

Figure 24: Reverse recovery time vs. diode current slope

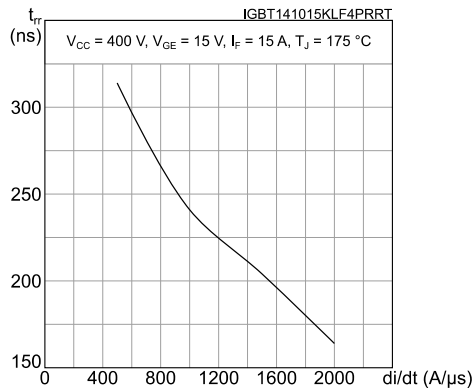

Figure 25: Reverse recovery charge vs. diode current slope

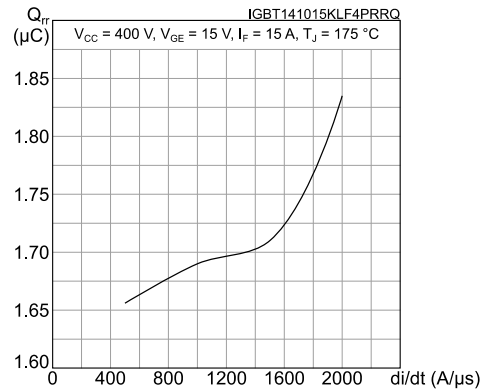

Figure 26: Reverse recovery energy vs. diode current slope

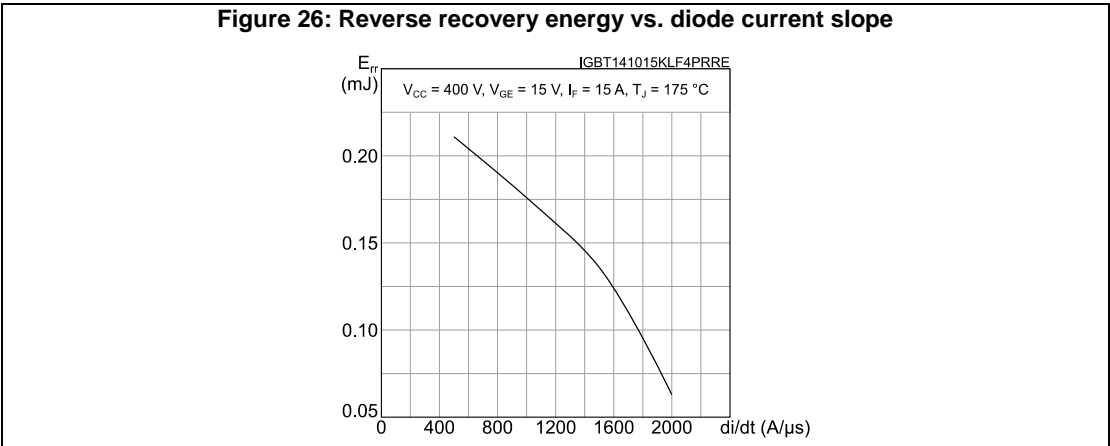

Figure 27: Thermal impedance for IGBT

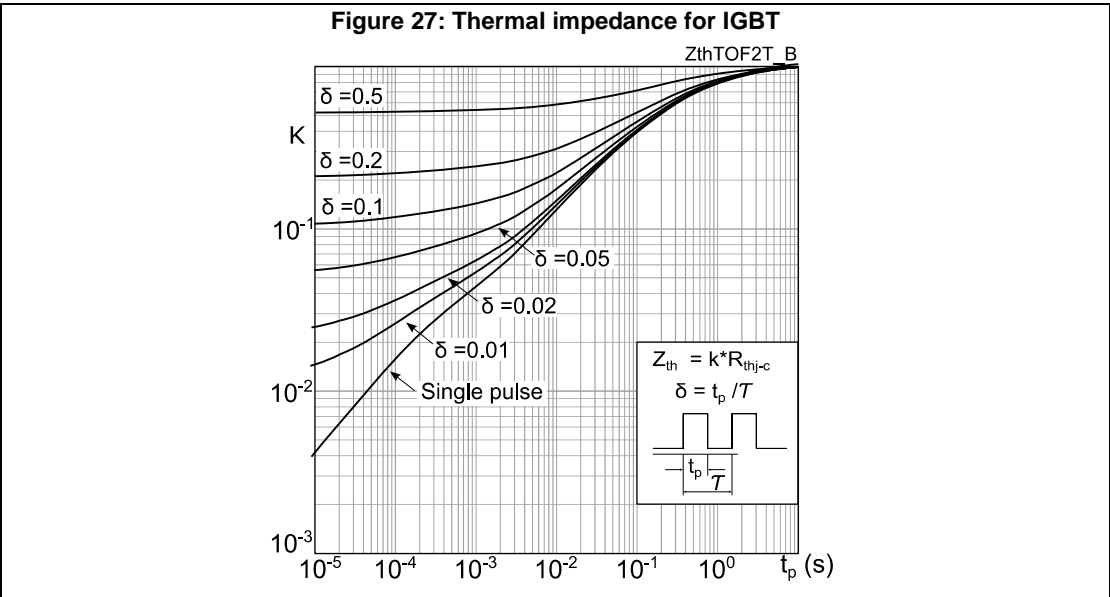
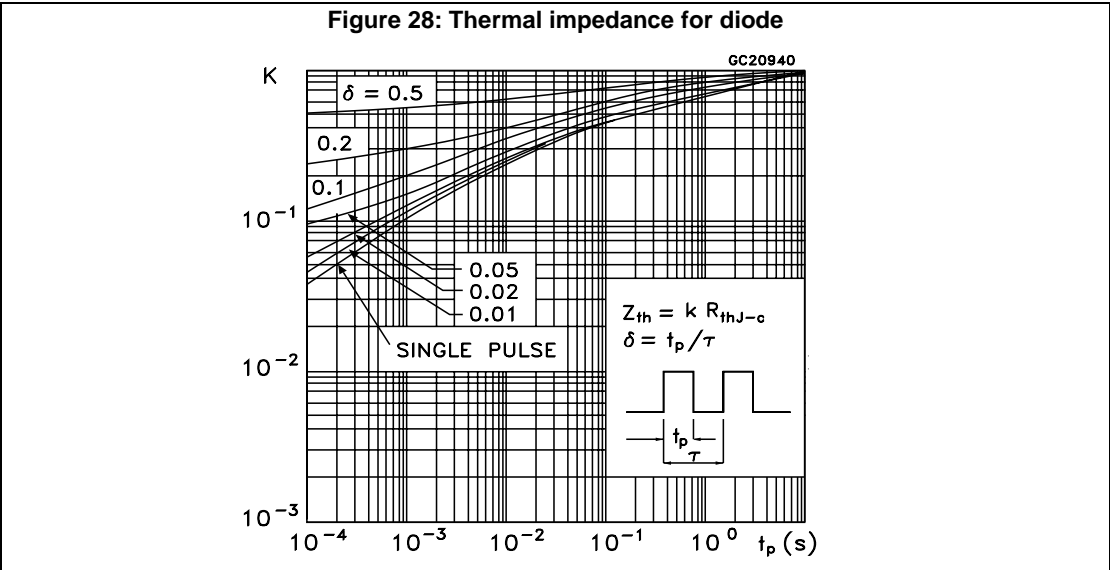
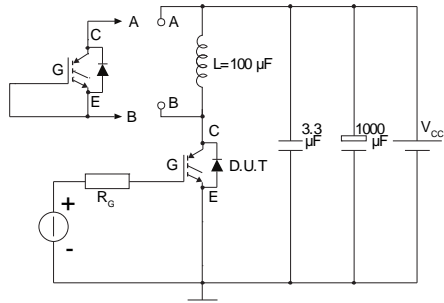

Figure 28: Thermal impedance for diode



### 3 Test circuits

**Figure 29: Test circuit for inductive load switching**



AM01504v1

**Figure 30: Gate charge test circuit**

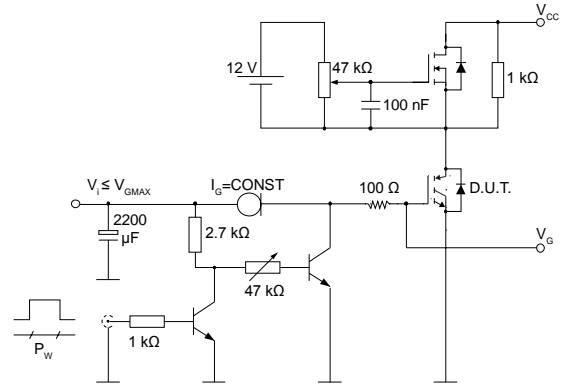

AM01505v1

**Figure 31: Switching waveform**

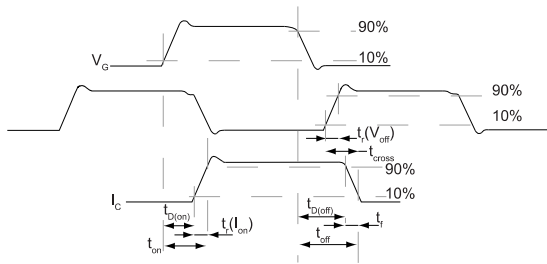

AM01506v1

**Figure 32: Diode reverse recovery waveform**

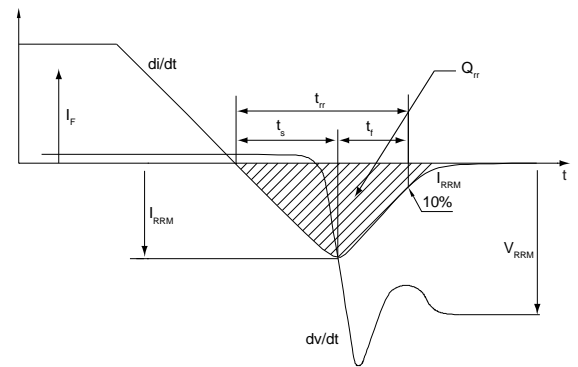

AM01507v1

## 4 Package information

In order to meet environmental requirements, ST offers these devices in different grades of ECOPACK® packages, depending on their level of environmental compliance. ECOPACK® specifications, grade definitions and product status are available at: [www.st.com](http://www.st.com). ECOPACK® is an ST trademark.

### 4.1 TO-220FP package information

Figure 33: TO-220FP package outline

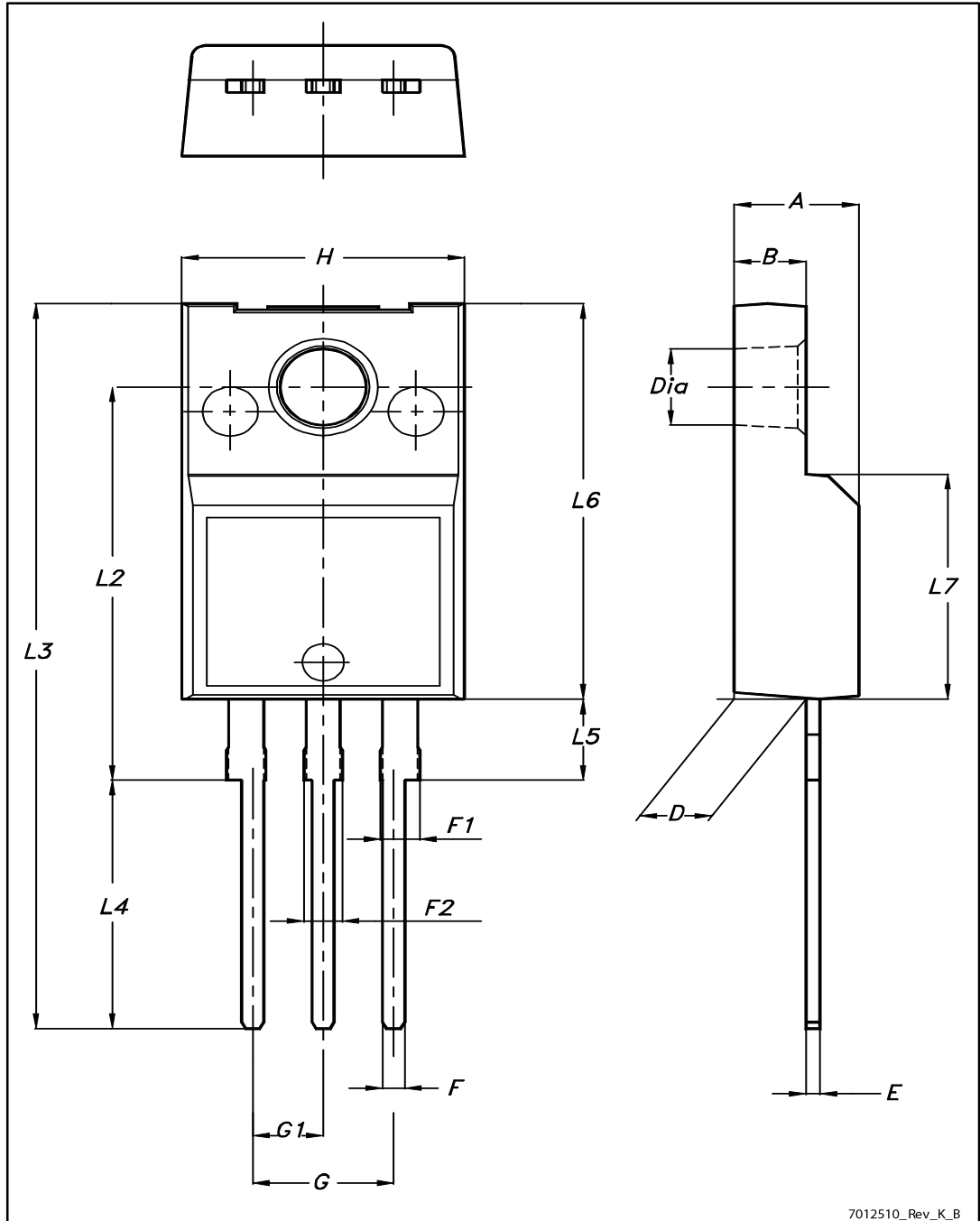

7012510\_Rev\_K\_B

Table 8: TO-220FP package mechanical data

Dim.	mm		
	Min.	Typ.	Max.
A	4.4		4.6
B	2.5		2.7
D	2.5		2.75
E	0.45		0.7
F	0.75		1
F1	1.15		1.70
F2	1.15		1.70
G	4.95		5.2
G1	2.4		2.7
H	10		10.4
L2		16	
L3	28.6		30.6
L4	9.8		10.6
L5	2.9		3.6
L6	15.9		16.4
L7	9		9.3
Dia	3		3.2

## 5 Revision history

Table 9: Document revision history

Date	Revision	Changes
14-Oct-2015	1	First release.

**IMPORTANT NOTICE – PLEASE READ CAREFULLY**

STMicroelectronics NV and its subsidiaries ("ST") reserve the right to make changes, corrections, enhancements, modifications, and improvements to ST products and/or to this document at any time without notice. Purchasers should obtain the latest relevant information on ST products before placing orders. ST products are sold pursuant to ST's terms and conditions of sale in place at the time of order acknowledgement.

Purchasers are solely responsible for the choice, selection, and use of ST products and ST assumes no liability for application assistance or the design of Purchasers' products.

No license, express or implied, to any intellectual property right is granted by ST herein.

Resale of ST products with provisions different from the information set forth herein shall void any warranty granted by ST for such product.

ST and the ST logo are trademarks of ST. All other product or service names are the property of their respective owners.

Information in this document supersedes and replaces information previously supplied in any prior versions of this document.

© 2015 STMicroelectronics – All rights reserved