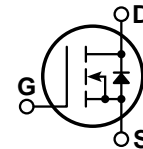
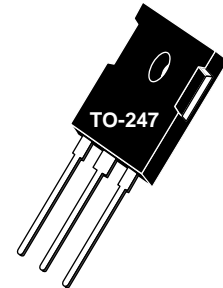


## POWER MOS V®

Power MOS V® is a new generation of high voltage N-Channel enhancement mode power MOSFETs. This new technology minimizes the JFET effect, increases packing density and reduces the on-resistance. Power MOS V® also achieves faster switching speeds through optimized gate layout.



- **Faster Switching**
- **100% Avalanche Tested**
- **Lower Leakage**
- **Popular TO-247 Package**

### MAXIMUM RATINGS

All Ratings:  $T_C = 25^\circ\text{C}$  unless otherwise specified.

Symbol	Parameter	APT20M38BVR	UNIT
$V_{DSS}$	Drain-Source Voltage	200	Volts
$I_D$	Continuous Drain Current @ $T_C = 25^\circ\text{C}$	67	Amps
$I_{DM}$	Pulsed Drain Current <sup>①</sup>	268	
$V_{GS}$	Gate-Source Voltage Continuous	$\pm 30$	Volts
$V_{GSM}$	Gate-Source Voltage Transient	$\pm 40$	
$P_D$	Total Power Dissipation @ $T_C = 25^\circ\text{C}$	370	Watts
	Linear Derating Factor	2.96	W/ $^\circ\text{C}$
$T_J, T_{STG}$	Operating and Storage Junction Temperature Range	-55 to 150	$^\circ\text{C}$
$T_L$	Lead Temperature: 0.063" from Case for 10 Sec.	300	
$I_{AR}$	Avalanche Current <sup>①</sup> (Repetitive and Non-Repetitive)	67	Amps
$E_{AR}$	Repetitive Avalanche Energy <sup>①</sup>	30	mJ
$E_{AS}$	Single Pulse Avalanche Energy <sup>④</sup>	1300	

### STATIC ELECTRICAL CHARACTERISTICS

Symbol	Characteristic / Test Conditions	MIN	TYP	MAX	UNIT
$BV_{DSS}$	Drain-Source Breakdown Voltage ( $V_{GS} = 0V, I_D = 250\mu\text{A}$ )	200			Volts
$I_{D(on)}$	On State Drain Current <sup>②</sup> ( $V_{DS} > I_{D(on)} \times R_{DS(on)}$ Max, $V_{GS} = 10V$ )	67			Amps
$R_{DS(on)}$	Drain-Source On-State Resistance <sup>②</sup> ( $V_{GS} = 10V, 0.5 I_{D[Cont.]}$ )			0.038	Ohms
$I_{DSS}$	Zero Gate Voltage Drain Current ( $V_{DS} = V_{DSS}, V_{GS} = 0V$ )			25	$\mu\text{A}$
	Zero Gate Voltage Drain Current ( $V_{DS} = 0.8 V_{DSS}, V_{GS} = 0V, T_C = 125^\circ\text{C}$ )			250	
$I_{GSS}$	Gate-Source Leakage Current ( $V_{GS} = \pm 30V, V_{DS} = 0V$ )			$\pm 100$	nA
$V_{GS(th)}$	Gate Threshold Voltage ( $V_{DS} = V_{GS}, I_D = 1.0\text{mA}$ )	2		4	Volts

 **CAUTION:** These Devices are Sensitive to Electrostatic Discharge. Proper Handling Procedures Should Be Followed.

**USA**  
405 S.W. Columbia Street

**EUROPE**  
Avenue J.F. Kennedy Bât B4 Parc Cadéra Nord

**APT Website - <http://www.advancedpower.com>**

Bend, Oregon 97702-1035

Phone: (541) 382-8028

FAX: (541) 388-0364

F-33700 Merignac - France

Phone: (33) 5 57 92 15 15

FAX: (33) 5 56 47 97 61

## DYNAMIC CHARACTERISTICS

APT20M38BVR

Symbol	Characteristic	Test Conditions	MIN	TYP	MAX	UNIT
$C_{iss}$	Input Capacitance	$V_{GS} = 0V$ $V_{DS} = 25V$ $f = 1 \text{ MHz}$		5100	6120	pF
$C_{oss}$	Output Capacitance			1145	1600	
$C_{rss}$	Reverse Transfer Capacitance			390	585	
$Q_g$	Total Gate Charge <sup>③</sup>	$V_{GS} = 10V$ $V_{DD} = 0.5 V_{DSS}$ $I_D = I_{D[Cont.]} @ 25^\circ C$		148	225	nC
$Q_{gs}$	Gate-Source Charge			47	75	
$Q_{gd}$	Gate-Drain ("Miller") Charge			75	110	
$t_{d(on)}$	Turn-on Delay Time	$V_{GS} = 15V$ $V_{DD} = 0.5 V_{DSS}$ $I_D = I_{D[Cont.]} @ 25^\circ C$ $R_G = 1.6\Omega$		14	28	ns
$t_r$	Rise Time			21	42	
$t_{d(off)}$	Turn-off Delay Time			48	75	
$t_f$	Fall Time			10	20	

## SOURCE-DRAIN DIODE RATINGS AND CHARACTERISTICS

Symbol	Characteristic / Test Conditions	MIN	TYP	MAX	UNIT
$I_S$	Continuous Source Current (Body Diode)			67	Amps
$I_{SM}$	Pulsed Source Current <sup>①</sup> (Body Diode)			268	
$V_{SD}$	Diode Forward Voltage <sup>②</sup> ( $V_{GS} = 0V, I_S = -I_{D[Cont.]}$ )			1.3	Volts
$t_{rr}$	Reverse Recovery Time ( $I_S = -I_{D[Cont.]}, di_S/dt = 100A/\mu s$ )		160		ns
$Q_{rr}$	Reverse Recovery Charge ( $I_S = -I_{D[Cont.]}, di_S/dt = 100A/\mu s$ )		1.3		$\mu C$

## THERMAL CHARACTERISTICS

Symbol	Characteristic	MIN	TYP	MAX	UNIT
$R_{\theta JC}$	Junction to Case			0.34	$^\circ C/W$
$R_{\theta JA}$	Junction to Ambient			40	

① Repetitive Rating: Pulse width limited by maximum junction temperature.

③ See MIL-STD-750 Method 3471

② Pulse Test: Pulse width < 380  $\mu s$ , Duty Cycle < 2%

④ Starting  $T_j = +25^\circ C$ ,  $L = 0.58mH$ ,  $R_G = 25\Omega$ , Peak  $I_L = 67A$

APT Reserves the right to change, without notice, the specifications and information contained herein.

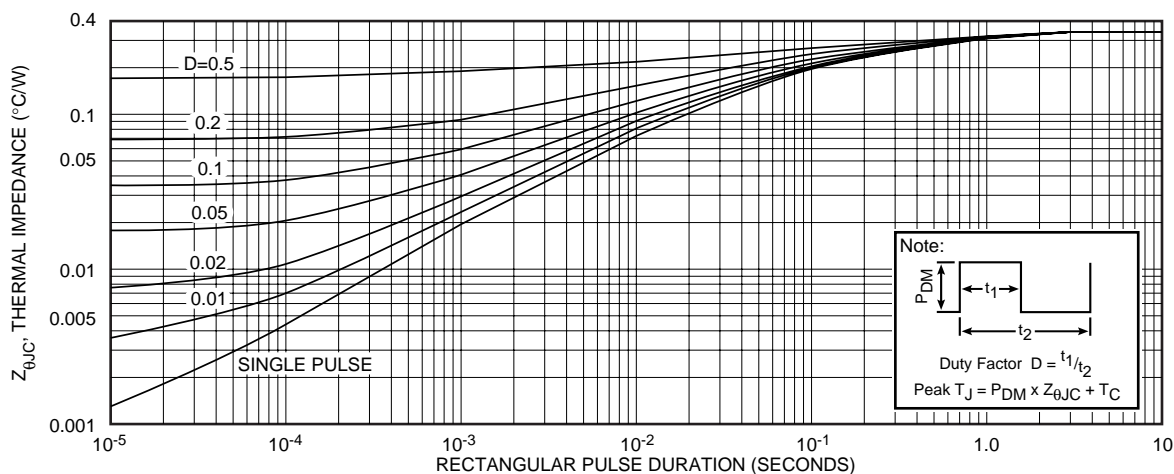
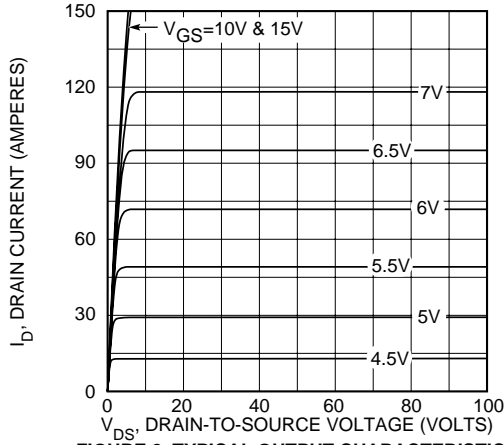
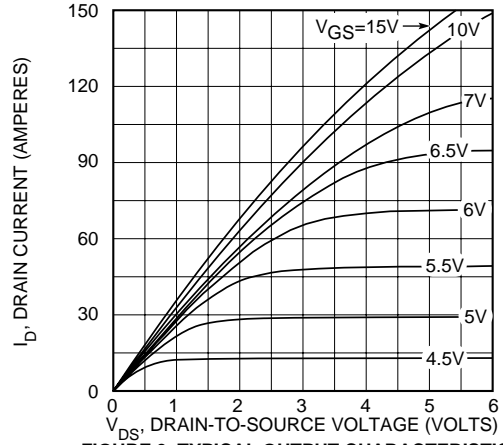


FIGURE 1, MAXIMUM EFFECTIVE TRANSIENT THERMAL IMPEDANCE, JUNCTION-TO-CASE vs PULSE DURATION

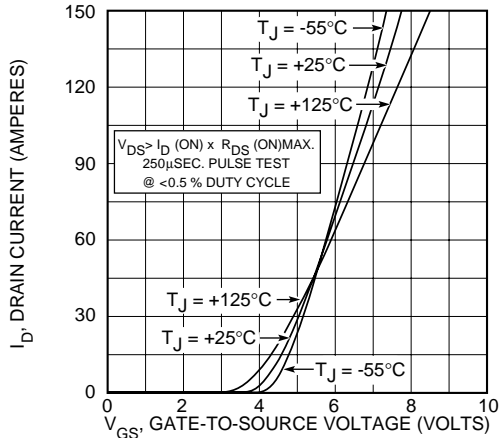
**APT20M38BVR**



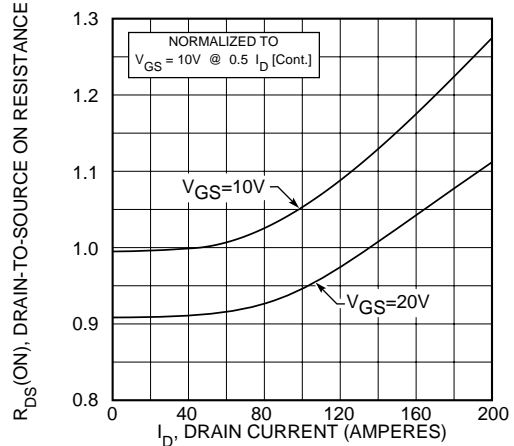
**FIGURE 2, TYPICAL OUTPUT CHARACTERISTICS**



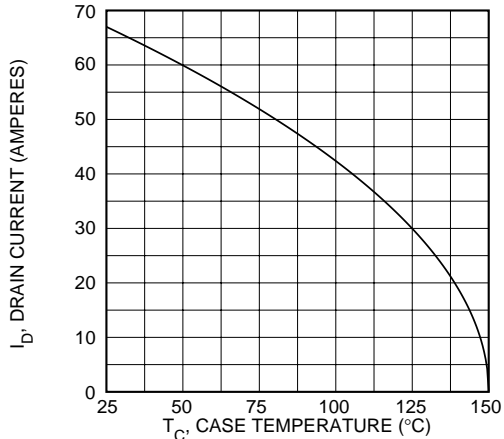
**FIGURE 3, TYPICAL OUTPUT CHARACTERISTICS**



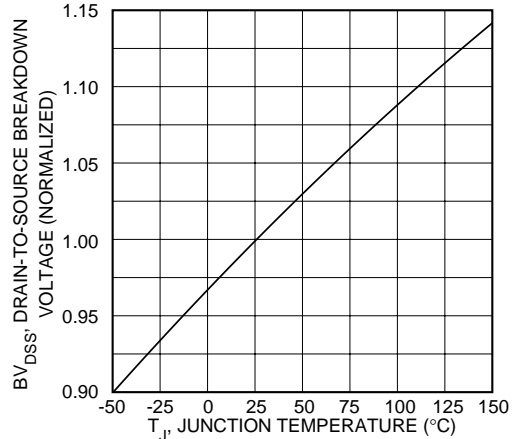
**FIGURE 4, TYPICAL TRANSFER CHARACTERISTICS**



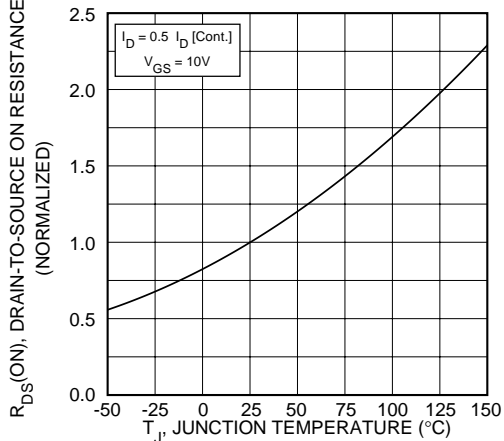
**FIGURE 5,  $R_{DS(ON)}$  vs DRAIN CURRENT**



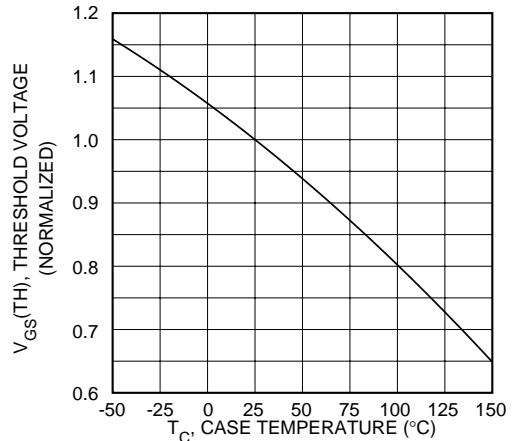
**FIGURE 6, MAXIMUM DRAIN CURRENT vs CASE TEMPERATURE**



**FIGURE 7, BREAKDOWN VOLTAGE vs TEMPERATURE**

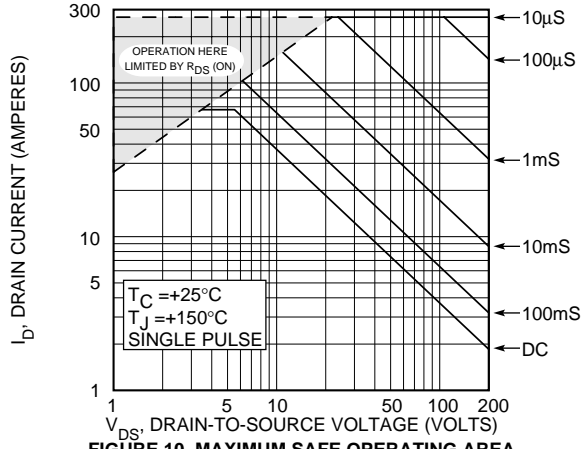


**FIGURE 8, ON-RESISTANCE vs. TEMPERATURE**

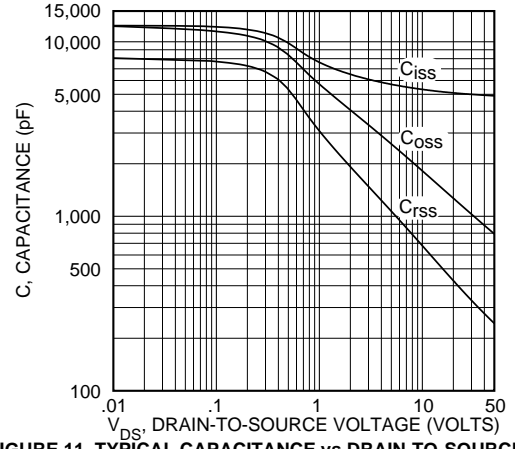


**FIGURE 9, THRESHOLD VOLTAGE vs TEMPERATURE**

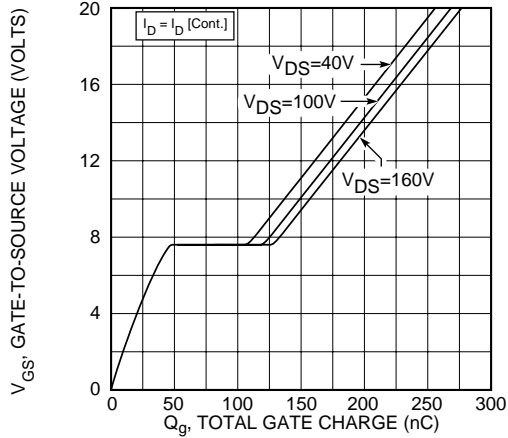
**APT20M38BVR**



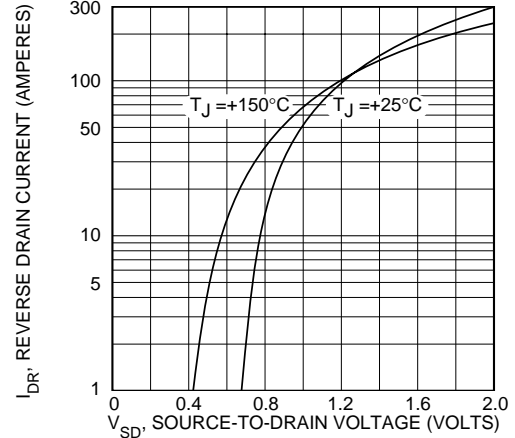
**FIGURE 10, MAXIMUM SAFE OPERATING AREA**



**FIGURE 11, TYPICAL CAPACITANCE vs DRAIN-TO-SOURCE VOLTAGE**

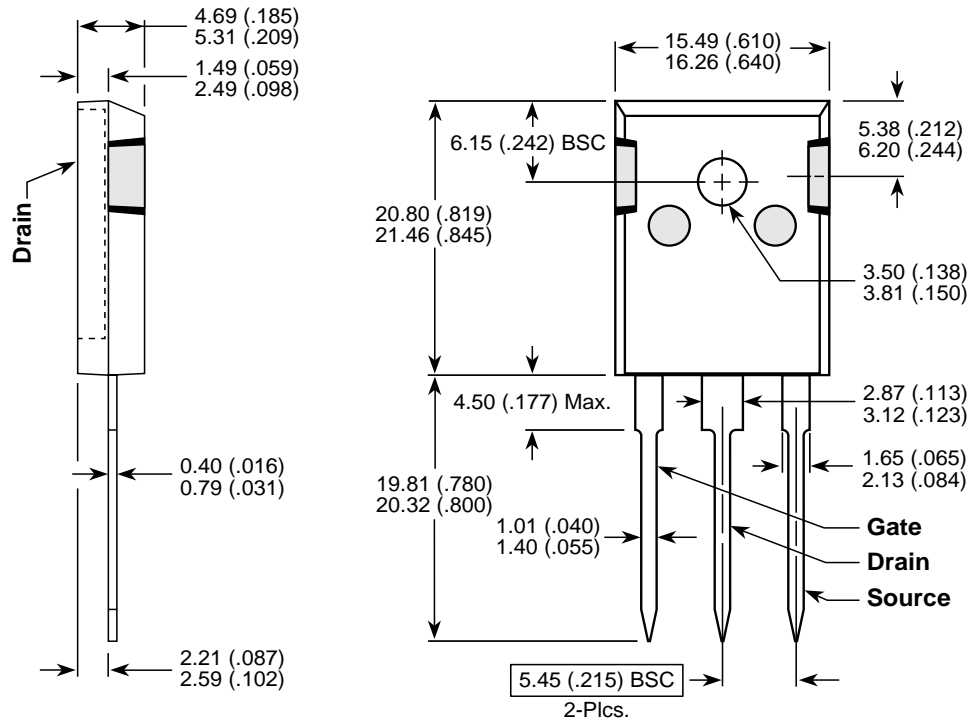


**FIGURE 12, GATE CHARGES vs GATE-TO-SOURCE VOLTAGE**



**FIGURE 13, TYPICAL SOURCE-DRAIN DIODE FORWARD VOLTAGE**

**TO-247 Package Outline**



Dimensions in Millimeters and (Inches)