

55140 Miniature Flange Mounting Sensor

RoHS

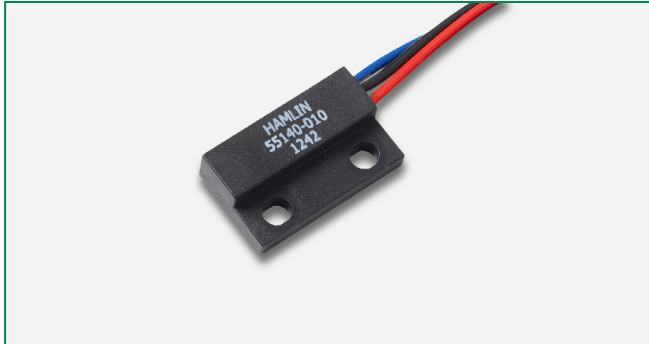

Block Diagram

Two-wire Version

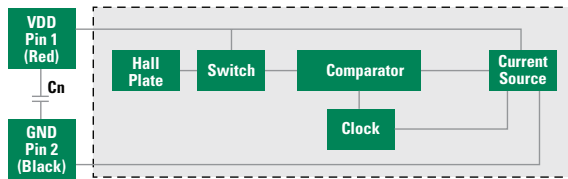

Notes:

1. Add capacitor **Cn** as shown, close for the sensors for transient suppression if required.
2. Add pull-up resistor **Rpu** as shown for sinking output. The Rpu value should be calculated using your supply voltage while keeping the ON state current at a level below the maximum. $R_{pu} = VDD/I_o$
 $R_{pu} = 12Vdc/10mA = 1.2$

Three-wire Version

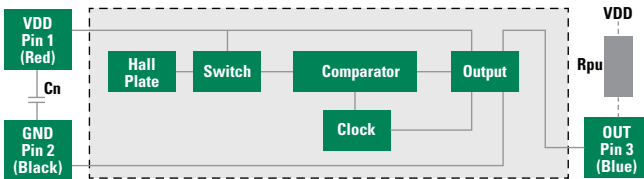

Description

The 55140 is a small flange mounting hall effect sensor occupying only 3.22cm² (0.500"×2") board space with a choice of digital, or programmable analogue outputs. It is available as three-wire (voltage output) or two-wire (current output) versions. It's case design enables screw or adhesive mounting and capable of switching up to 28Vdc and 20mA. It comes with a range of sensitivity, cable length and connector options.

Features

- Magnetically operated position sensor
- Digital, latching or programmable analog types available
- Medium, high or programmable sensitivities
- Three-wire (voltage output) or two-wire (current output) versions
- Vibration 50g max. @ 50-2,000Hz
- Shock 150g max. @ 11ms ½ Sine
- EMC to DIN 40839 (Consult Littelfuse)
- Reverse/Over voltage protection
- Built in temperature compensation
- Open Drain Output

Benefits

- High switching speed up to 10kHz
- Long life; up to 20 billion operations
- Operates in static or dynamic magnetic field
- Unaffected by harsh environment
- Customer selection of cable length and connector type

Applications

- Position and limit sensing
- RPM measurement
- Commutation of brushless DC motors
- Flow metering
- Angle sensing
- Magnetic encoders

Dimensions

Dimensions in mm (inch)

Two-wire version illustrated.

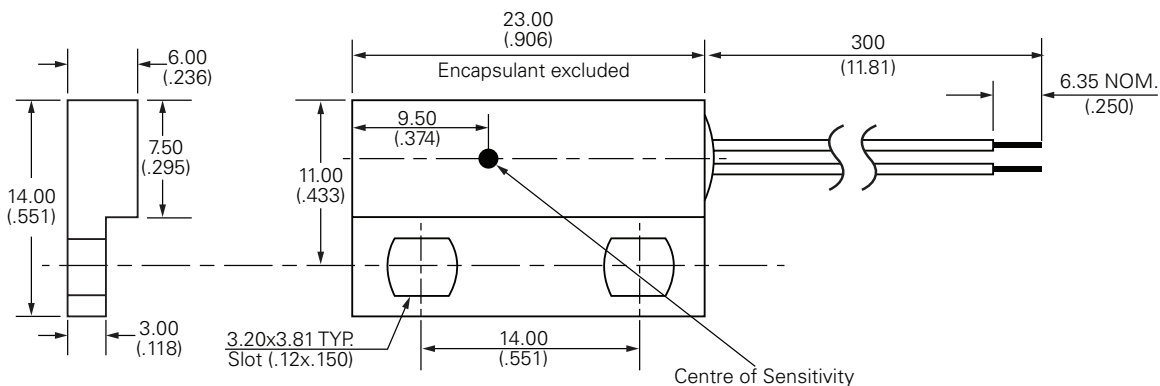

General Tol.: ±(.005) 0.13

55140 Miniature Flange Mounting Sensor

Electrical Ratings

Hall Type			Digital Switch Three-Wire (Voltage Output)	Digital Switch Two-Wire (Current Output)	A - Analogue (Programmable Only) ²
Supply Voltage ¹	Absolute Ratings	Vdc	-15 to +28	-15 to +28	8.5
	Operate	Vdc	+3.8 to +24	+3.75 to +24	4.5 - 5.5
		Vdc - max.	32	32	19.5
Output High Voltage		Vdc - min.	Sinking output	N/A	4.65
Output Low Voltage		Vdc - max.	0.4 @ 20mA	N/A	0.35
Output Current (continuously on)		mA - max.	20	N/A	-1.0 to +1.0
Current Consumption Over Temperature Range	Low	mA - min.	1.6 - 5.2	5.0 - 6.9	2.0 - 10.0
	High	mA - max.	1.6 - 5.2	12.0 - 17.0	2.0 - 10.0
Switching Speed		kHz	10	10	2
Temperature	Operating	°C	-40 to +100	-40 to +100	-40 to +100

Notes:

- As long as T_j (Junction Temperature) is not exceeded. It is recommended to operate within the normal Operate Supply Voltage of +24Vdc maximum. Operating beyond Absolute Ratings may cause permanent damage to the Hall IC.
- Preprogrammed by Littelfuse or Customer pending agreement.
- For custom modifications to the wire length or size, or adding a special connector, please contact Littelfuse.

55140 Miniature Flange Mounting Sensor

Hall Options

Select Option	Hall Type	Sensitivity Gauss (typ.)	Activate - D mm (inch)
2M	2 Wire Switch	120	13.5 (.531)
2H	2 Wire Switch	57	18.5 (.728)
3M	3 Wire Switch	130	12.5 (.492)
3H	3 Wire Switch	59	18.0 (.709)
AP	Analog	Programmable	Consult Littelfuse

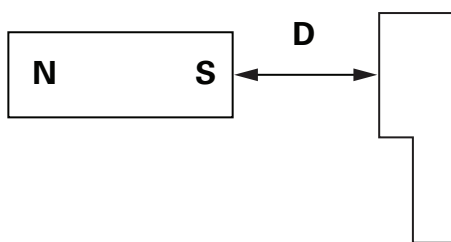

Note: Active distances are approximate using NEFEB Magnet 21 x 7 x 4.7 (.827L x .276W x .185H) LITTELFUSE P/N H-58



Cable Length Options

Cable Type: 24AWG 7/32 PVC 105°C UL 1430/UL1569

Select Option	Cable Length mm (inch)
02	300 (11.81)

Termination Specification

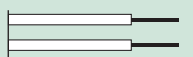
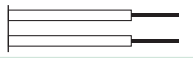
Termination Options

Select Option	Description (Two-wire versions illustrated)
A	Tinned leads (6.4±0.76)mm 
F	Untinned leads (6.4±0.76)mm 
E	JST type XHP 2.5mm pitch 

Part Numbering System

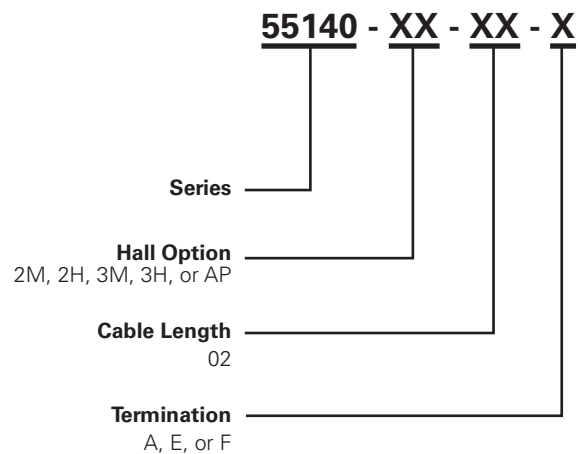

Packaging

Packaging Option	Packaging Specification	Quantity	Quantity & Packaging Code	Taping Width
Bulk	Bulk	500	N/A	N/A