

ITS 3100 A (PHM) and ITS 4100 A (PHM) Front Panel Mount Square Flange Receptacle Assembly with Environmental PHM Backshell

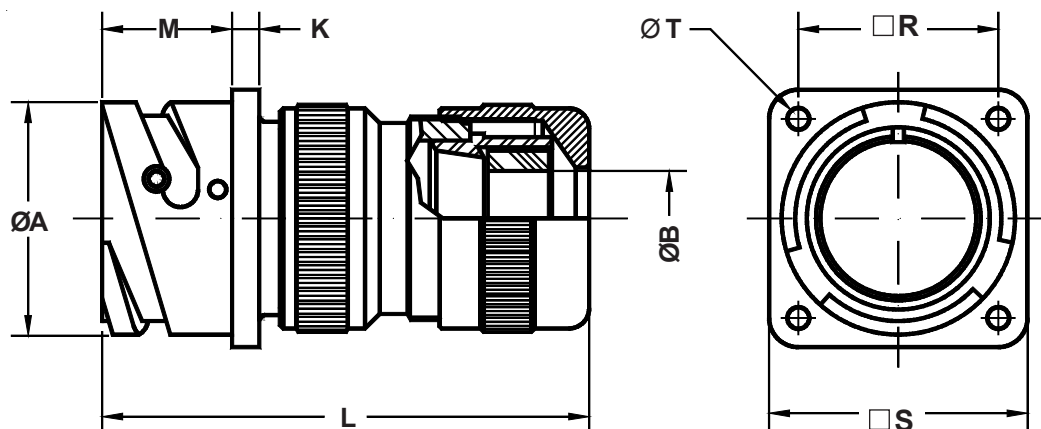
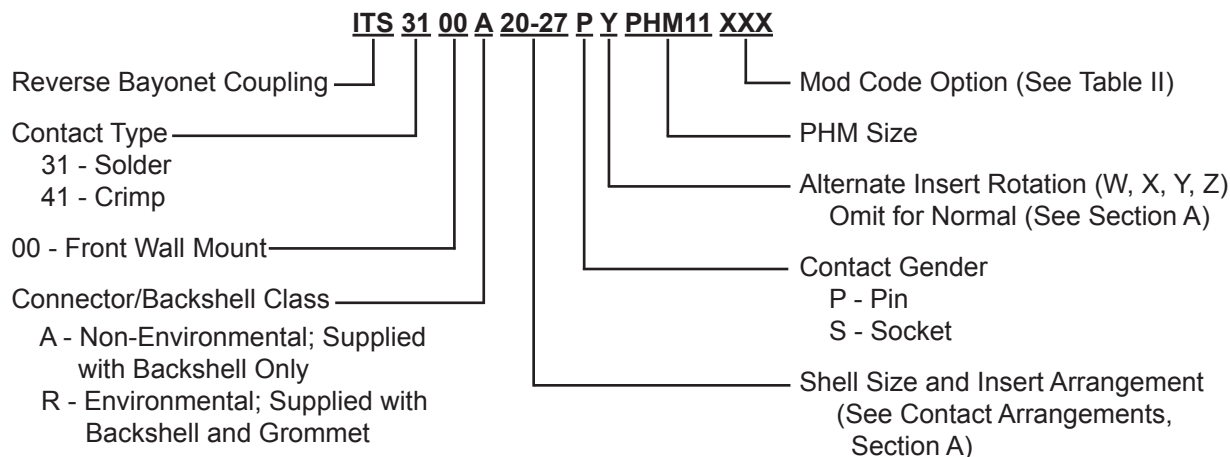

Application Notes:

1. Front panel mount square flange receptacle with environmental PHM backshell. Through mounting holes.
2. Connector/Backshell Class "A" (non-environmental)—Not supplied with wire sealing grommet; Class "R" (environmental)—Supplied with backshell and grommet.
3. Standard materials configuration consists of aluminum alloy. For platings, see TABLE II finish options.
4. Standard contact material consists of copper alloy with silver plating or gold plating.
5. A broad range of other connector accessories are available. See our website and/or contact the factory for complete information.
6. Standard insert material is synthetic rubber. Add "FR" prefix to front of part number to specify fire resistant inserts.

ITS 3100 A (PHM) and ITS 4100 A (PHM)
Front Panel Mount Square Flange Receptacle Assembly
with Environmental PHM Backshell



TABLE I: DIMENSIONS

Shell Size	PHM Size	ØA +0 -0.1	ØB min. – Max.	K ±0.2	L Max.	M +0.2 -0	R ±0.1	S +0.2	ØT +0.1 -0
10 SL	9	18.2	2-9	2.8	60	14.3	18.25	25.4	3.2
14 S	11	24.5	2-11	3.3	60	14.5	23.00	30.4	3.2
16 S	11	27.2	2-11	3.3	60	14.5	24.60	32.5	3.2
16	11	27.2	2-11	3.3	70	19.1	24.60	32.5	3.2
18	11 / 18	30.7	2-11 / 2-16.5	4.0	70	19.1	27.00	35.0	3.2
20	11 / 18	34.0	2-11 / 2-16.5	4.0	70	19.1	29.40	38.0	3.2
22	18	37.3	2-16.5	4.0	70	19.6	31.75	41.0	3.2
24	18 / 22 / 24	40.9	2-16.5 / 15-20 / 19-24	4.0	80	20.6	34.90	44.5	3.7
28	18 / 22 / 24	46.7	2-16.5 / 15-20 / 19-24	4.0	80	20.7	39.70	50.9	3.7
32	22 / 24	53.4	15-20 / 19-24	4.0	80	22.3	44.45	57.0	4.3
36	35	59.6	23-35	4.0	95	22.3	49.20	63.5	4.3
40	35	65.5	23-35	4.0	95	22.3	55.55	69.9	4.3



TABLE II: MODIFICATION CODES

CONTACT OPTIONS	
Sym	Description
B0	Connector Less Contacts
B1	Connector with Gold Plated Contacts
Omit for standard version (Silver plated)	
FINISH OPTIONS	
Sym	Description and RoHS compliant (*)
F2	Bright Nickel Plating (*)
F6	Black Electrodeposited Paint (*)
F7	Black Zn-Co Plating (*)
F8	Olive Drab Zn-Co Plating
F11	Electroless Nickel (*)
Omit for standard version (Cadmium Olive Drab Finish)	