

**Typical Applications**

- Industrial Motor Drive

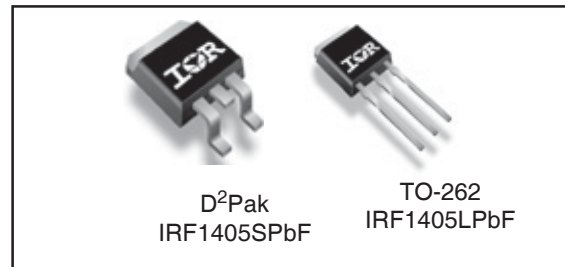
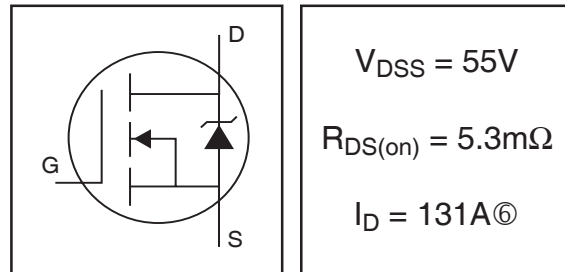
**Benefits**

- Advanced Process Technology
- Ultra Low On-Resistance
- Dynamic dv/dt Rating
- 175°C Operating Temperature
- Fast Switching
- Repetitive Avalanche Allowed up to Tjmax

**Description**

Stripe Planar design of HEXFET® Power MOSFETs utilizes the latest processing techniques to achieve extremely low on-resistance per silicon area. Additional features of this HEXFET power MOSFET are a 175°C junction operating temperature, fast switching speed and improved repetitive avalanche rating. These benefits combine to make this design an extremely efficient and reliable device for use in a wide variety of applications.

HEXFET® Power MOSFET



**Absolute Maximum Ratings**

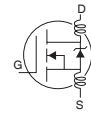
	Parameter	Max.	Units
I <sub>D</sub> @ T <sub>C</sub> = 25°C	Continuous Drain Current, V <sub>GS</sub> @ 10V	131 <sup>Ⓒ</sup>	A
I <sub>D</sub> @ T <sub>C</sub> = 100°C	Continuous Drain Current, V <sub>GS</sub> @ 10V	93 <sup>Ⓒ</sup>	
I <sub>DM</sub>	Pulsed Drain Current <sup>Ⓓ</sup>	680	
P <sub>D</sub> @ T <sub>C</sub> = 25°C	Power Dissipation	200	W
	Linear Derating Factor	1.3	W/°C
V <sub>GS</sub>	Gate-to-Source Voltage	± 20	V
E <sub>AS</sub>	Single Pulse Avalanche Energy <sup>Ⓔ</sup>	590	mJ
I <sub>AR</sub>	Avalanche Current	See Fig.12a, 12b, 15, 16	A
E <sub>AR</sub>	Repetitive Avalanche Energy <sup>Ⓕ</sup>		mJ
dv/dt	Peak Diode Recovery dv/dt <sup>Ⓖ</sup>	5.0	V/ns
T <sub>J</sub>	Operating Junction and	-55 to + 175	°C
T <sub>STG</sub>	Storage Temperature Range		
	Soldering Temperature, for 10 seconds		
	Mounting Torque, 6-32 or M3 screw	10 lbf•in (1.1N•m)	

**Thermal Resistance**

	Parameter	Typ.	Max.	Units
R <sub>θJC</sub>	Junction-to-Case	—	0.75	°C/W
R <sub>θJA</sub>	Junction-to-Ambient (PCB mount) <sup>Ⓖ</sup>	—	40	

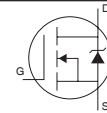
## Electrical Characteristics @ $T_J = 25^\circ\text{C}$ (unless otherwise specified)

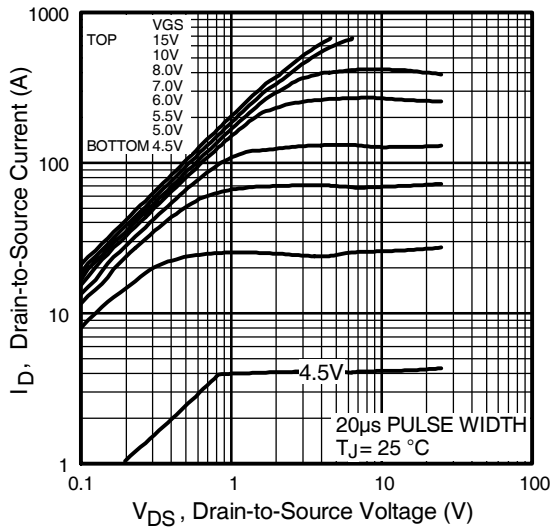
	Parameter	Min.	Typ.	Max.	Units	Conditions
$V_{(BR)DSS}$	Drain-to-Source Breakdown Voltage	55	—	—	V	$V_{GS} = 0V, I_D = 250\mu A$
$\Delta V_{(BR)DSS}/\Delta T_J$	Breakdown Voltage Temp. Coefficient	—	0.057	—	$V/^\circ\text{C}$	Reference to $25^\circ\text{C}, I_D = 1\text{mA}$
$R_{DS(on)}$	Static Drain-to-Source On-Resistance	—	4.6	5.3	$\text{m}\Omega$	$V_{GS} = 10V, I_D = 101A$ ④
$V_{GS(th)}$	Gate Threshold Voltage	2.0	—	4.0	V	$V_{DS} = 10V, I_D = 250\mu A$
$g_{fs}$	Forward Transconductance	69	—	—	S	$V_{DS} = 25V, I_D = 110A$
$I_{DSS}$	Drain-to-Source Leakage Current	—	—	20	$\mu A$	$V_{DS} = 55V, V_{GS} = 0V$
		—	—	250		$V_{DS} = 44V, V_{GS} = 0V, T_J = 150^\circ\text{C}$
$I_{GSS}$	Gate-to-Source Forward Leakage	—	—	200	nA	$V_{GS} = 20V$
	Gate-to-Source Reverse Leakage	—	—	-200		$V_{GS} = -20V$
$Q_g$	Total Gate Charge	—	170	260	nC	$I_D = 101A$
$Q_{gs}$	Gate-to-Source Charge	—	44	66		$V_{DS} = 44V$
$Q_{gd}$	Gate-to-Drain ("Miller") Charge	—	62	93		$V_{GS} = 10V$ ④
$t_{d(on)}$	Turn-On Delay Time	—	13	—	ns	$V_{DD} = 38V$
$t_r$	Rise Time	—	190	—		$I_D = 110A$
$t_{d(off)}$	Turn-Off Delay Time	—	130	—		$R_G = 1.1\Omega$
$t_f$	Fall Time	—	110	—		$V_{GS} = 10V$ ④
$L_D$	Internal Drain Inductance	—	4.5	—	nH	Between lead, 6mm (0.25in.) from package and center of die contact
$L_S$	Internal Source Inductance	—	7.5	—		
$C_{iss}$	Input Capacitance	—	5480	—	pF	$V_{GS} = 0V$
$C_{oss}$	Output Capacitance	—	1210	—		$V_{DS} = 25V$
$C_{rss}$	Reverse Transfer Capacitance	—	280	—		$f = 1.0\text{MHz}$ , See Fig. 5
$C_{oss}$	Output Capacitance	—	5210	—		$V_{GS} = 0V, V_{DS} = 1.0V, f = 1.0\text{MHz}$
$C_{oss}$	Output Capacitance	—	900	—		$V_{GS} = 0V, V_{DS} = 44V, f = 1.0\text{MHz}$
$C_{oss \text{ eff.}}$	Effective Output Capacitance ⑤	—	1500	—		$V_{GS} = 0V, V_{DS} = 0V \text{ to } 44V$



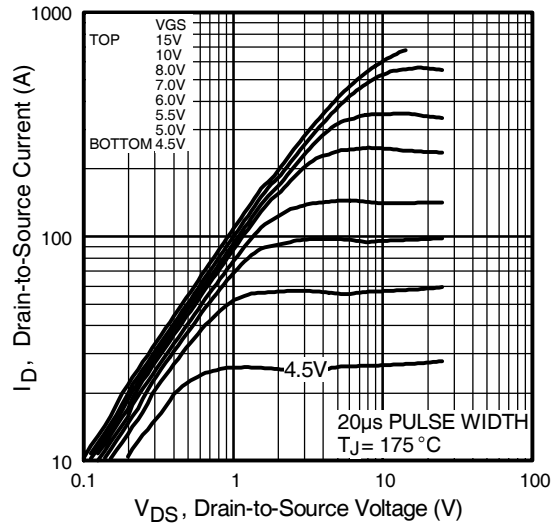
## Source-Drain Ratings and Characteristics

	Parameter	Min.	Typ.	Max.	Units	Conditions
$I_S$	Continuous Source Current (Body Diode)	—	—	131	A	MOSFET symbol showing the integral reverse p-n junction diode.
$I_{SM}$	Pulsed Source Current (Body Diode) ①	—	—	680		
$V_{SD}$	Diode Forward Voltage	—	—	1.3	V	$T_J = 25^\circ\text{C}, I_S = 101A, V_{GS} = 0V$ ④
$t_{rr}$	Reverse Recovery Time	—	88	130	ns	$T_J = 25^\circ\text{C}, I_F = 101A$
$Q_{rr}$	Reverse Recovery Charge	—	250	380	nC	$di/dt = 100A/\mu s$ ④
$t_{on}$	Forward Turn-On Time	Intrinsic turn-on time is negligible (turn-on is dominated by $L_S + L_D$ )				

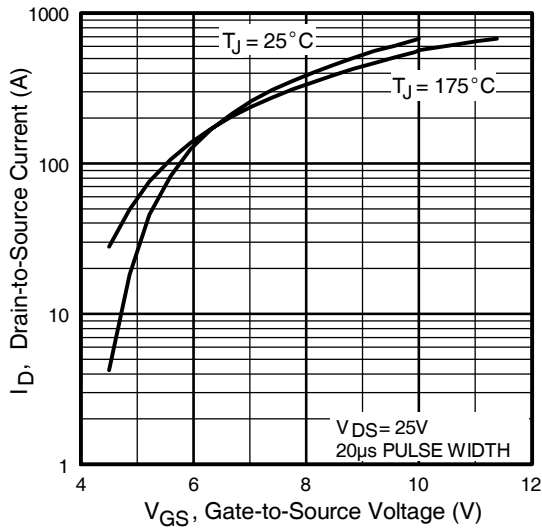




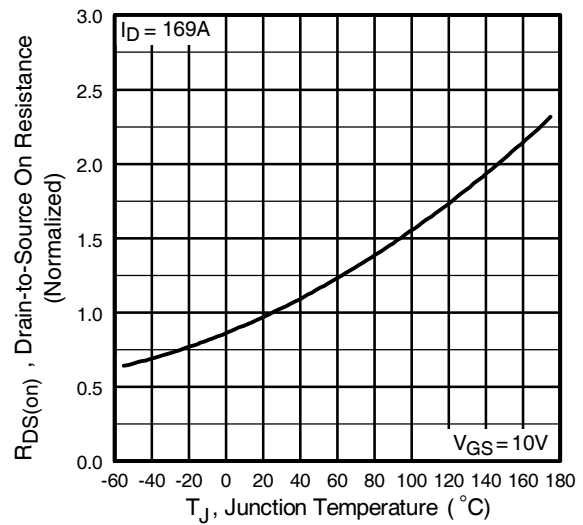
**Fig 1.** Typical Output Characteristics



**Fig 2.** Typical Output Characteristics



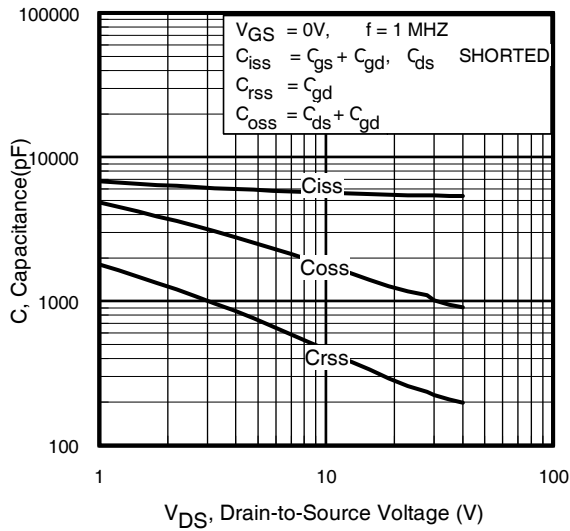
**Fig 3.** Typical Transfer Characteristics



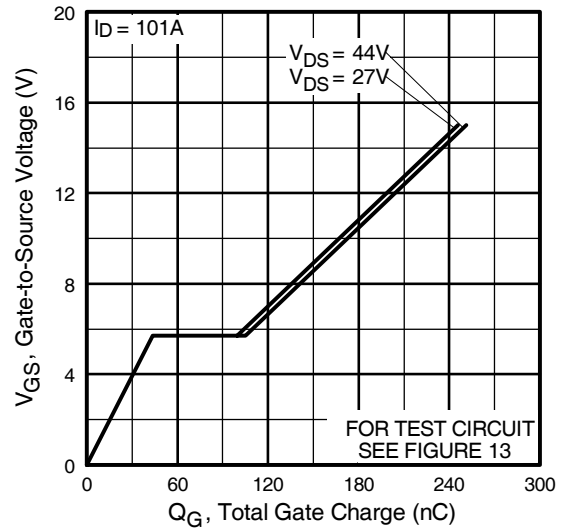
**Fig 4.** Normalized On-Resistance Vs. Temperature

# IRF1405S/LPbF

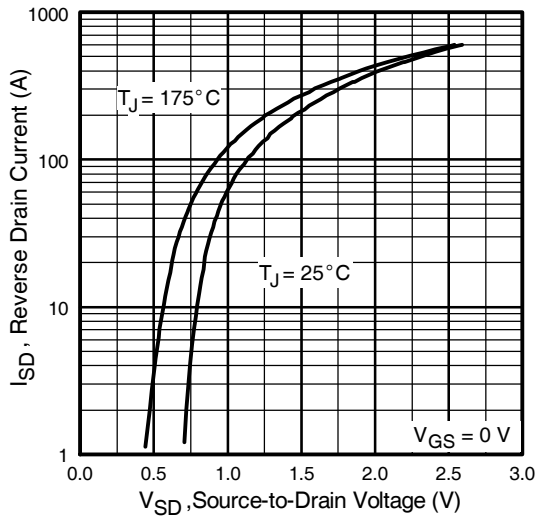
International  
**IR** Rectifier



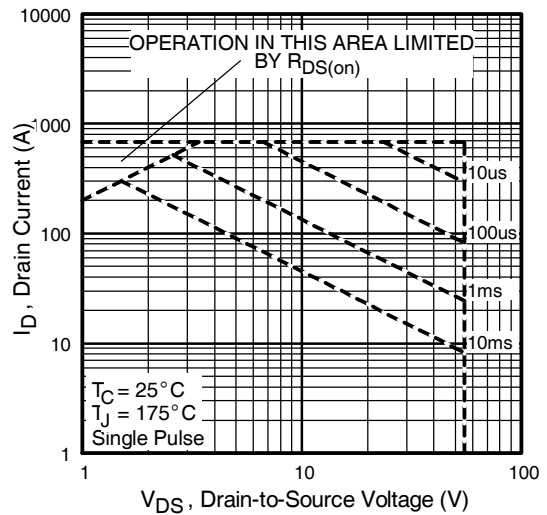
**Fig 5.** Typical Capacitance Vs. Drain-to-Source Voltage



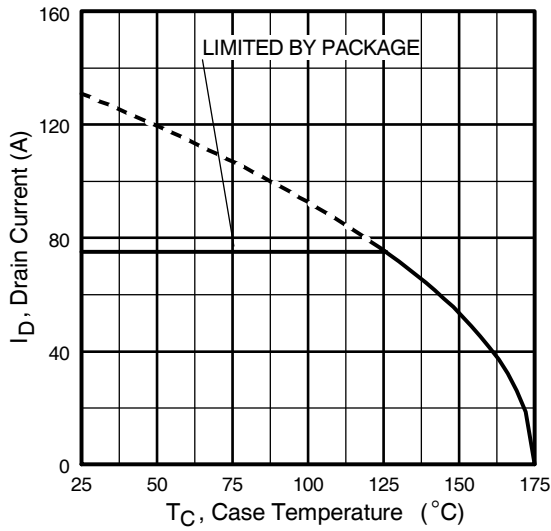
**Fig 6.** Typical Gate Charge Vs. Gate-to-Source Voltage



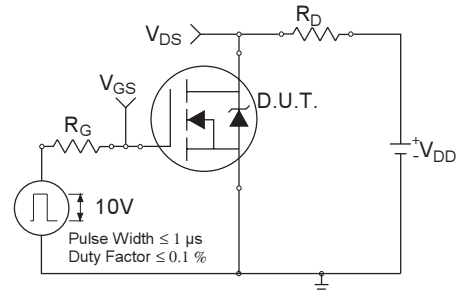
**Fig 7.** Typical Source-Drain Diode Forward Voltage



**Fig 8.** Maximum Safe Operating Area



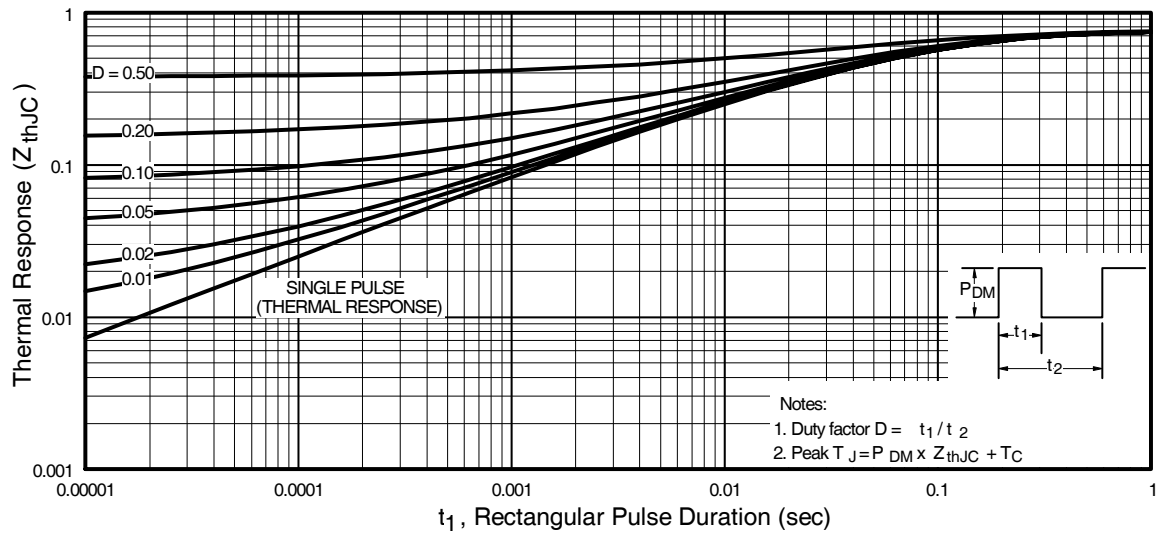
**Fig 9.** Maximum Drain Current Vs. Case Temperature



**Fig 10a.** Switching Time Test Circuit



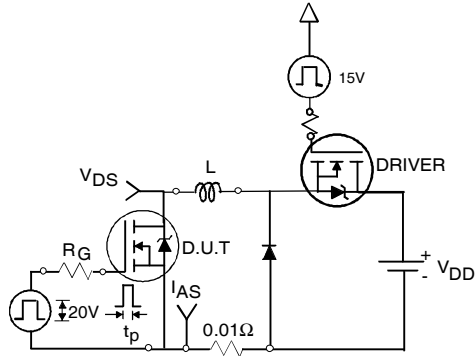
**Fig 10b.** Switching Time Waveforms



**Fig 11.** Maximum Effective Transient Thermal Impedance, Junction-to-Case

# IRF1405S/LPbF

International  
**IR** Rectifier



**Fig 12a.** Unclamped Inductive Test Circuit



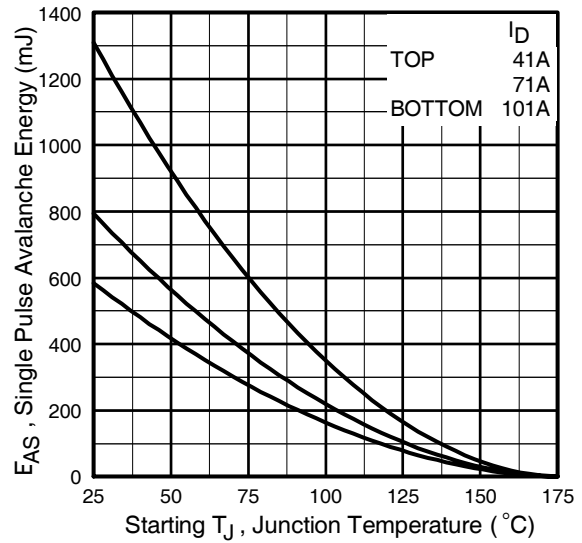
**Fig 12b.** Unclamped Inductive Waveforms



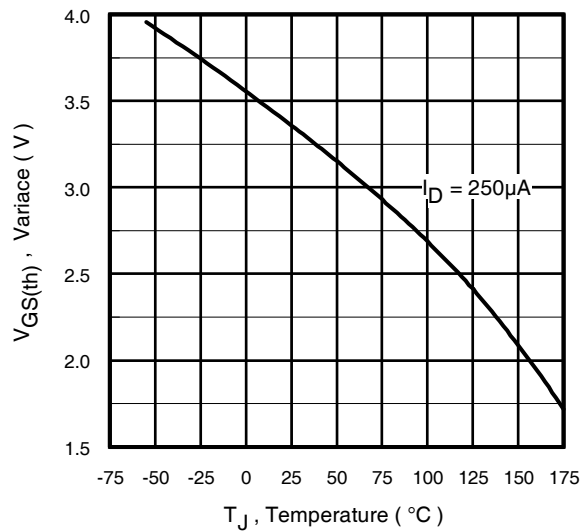
**Fig 13a.** Basic Gate Charge Waveform



**Fig 13b.** Gate Charge Test Circuit



**Fig 12c.** Maximum Avalanche Energy Vs. Drain Current



**Fig 14.** Threshold Voltage Vs. Temperature

www.irf.com

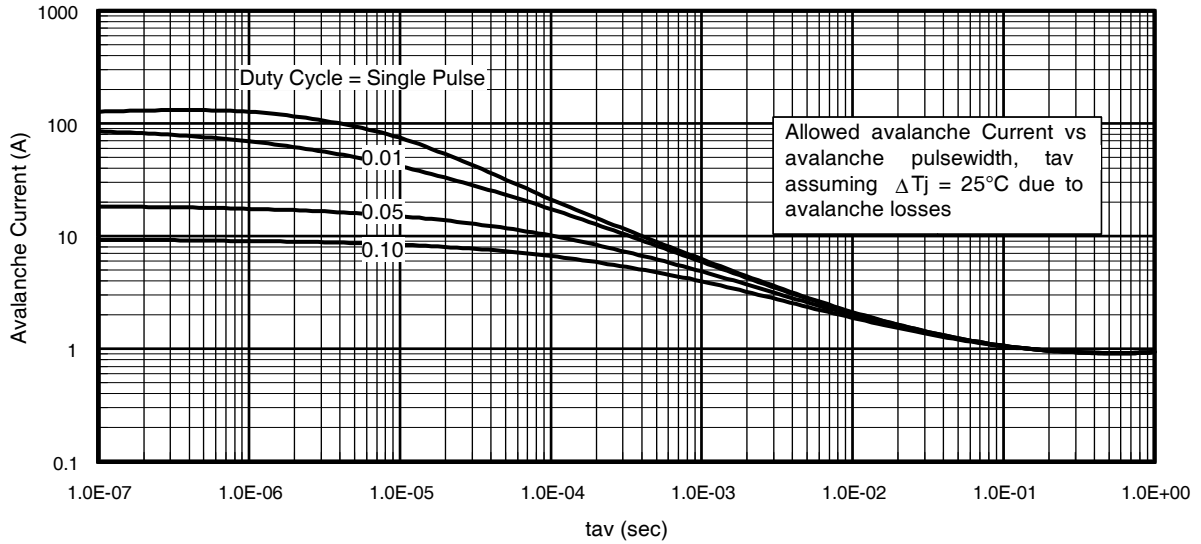


Fig 15. Typical Avalanche Current Vs.Pulsewidth

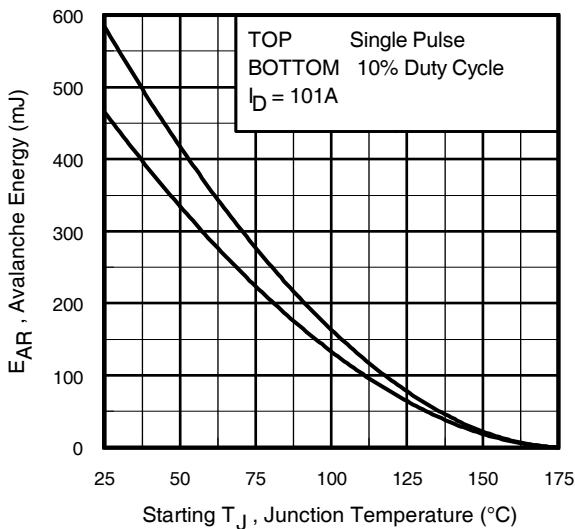


Fig 16. Maximum Avalanche Energy Vs. Temperature

**Notes on Repetitive Avalanche Curves , Figures 15, 16:  
(For further info, see AN-1005 at www.irf.com)**

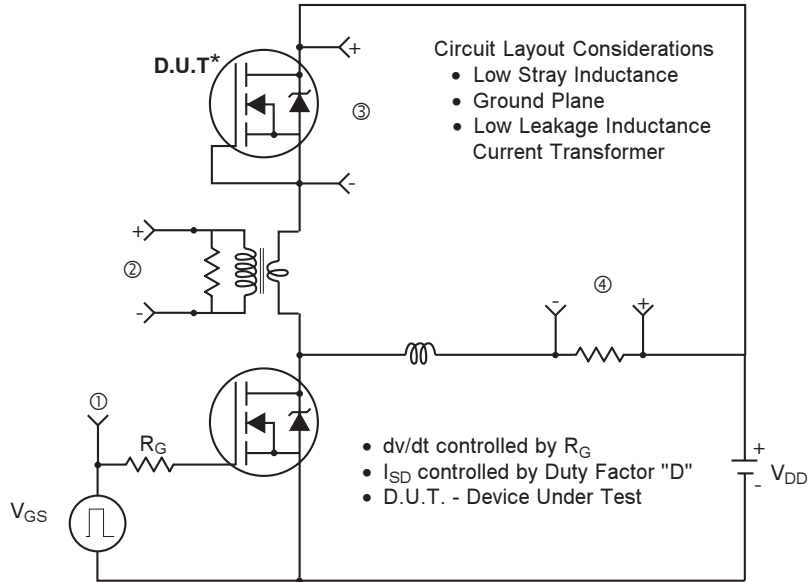
1. Avalanche failures assumption:  
Purely a thermal phenomenon and failure occurs at a temperature far in excess of  $T_{jmax}$ . This is validated for every part type.
2. Safe operation in Avalanche is allowed as long as  $T_{jmax}$  is not exceeded.
3. Equation below based on circuit and waveforms shown in Figures 12a, 12b.
4.  $P_{D(ave)}$  = Average power dissipation per single avalanche pulse.
5. BV = Rated breakdown voltage (1.3 factor accounts for voltage increase during avalanche).
6.  $I_{av}$  = Allowable avalanche current.
7.  $\Delta T$  = Allowable rise in junction temperature, not to exceed  $T_{jmax}$  (assumed as 25°C in Figure 15, 16).  
 $t_{av}$  = Average time in avalanche.  
D = Duty cycle in avalanche =  $t_{av} \cdot f$   
 $Z_{thJC}(D, t_{av})$  = Transient thermal resistance, see figure 11)

$$P_{D(ave)} = 1/2 ( 1.3 \cdot BV \cdot I_{av} ) = \Delta T / Z_{thJC}$$

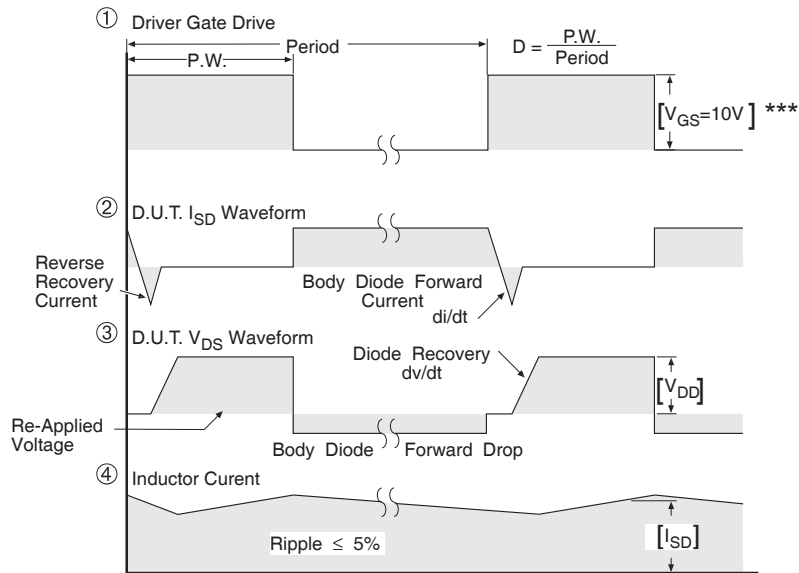
$$I_{av} = 2\Delta T / [1.3 \cdot BV \cdot Z_{th}]$$

$$E_{AS(AR)} = P_{D(ave)} \cdot t_{av}$$

## Peak Diode Recovery dv/dt Test Circuit



\* Reverse Polarity of D.U.T for P-Channel



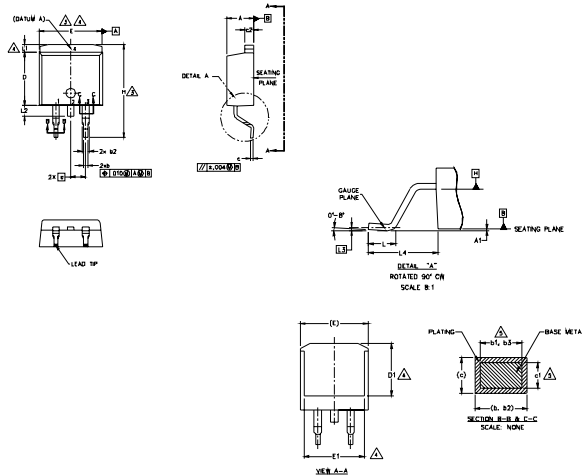
\*\*\*  $V_{GS} = 5.0V$  for Logic Level and 3V Drive Devices

**Fig 17.** For N-channel HEXFET® power MOSFETs



## D<sup>2</sup>Pak (TO-263AB) Package Outline

Dimensions are shown in millimeters (inches)



SYMBOL	DIMENSIONS				NOTES
	MILLIMETERS		INCHES		
	MIN.	MAX.	MIN.	MAX.	
A	4.06	4.83	.160	.190	
A1	0.00	0.254	.000	.010	
b	0.51	0.99	.020	.039	
b1	0.51	0.89	.020	.035	5
b2	1.14	1.78	.045	.070	
b3	1.14	1.73	.045	.068	5
c	0.38	0.74	.015	.029	
c1	0.38	0.58	.015	.023	5
c2	1.14	1.65	.045	.065	
D	8.38	9.65	.330	.380	3
D1	6.86	—	.270	—	4
E	9.65	10.67	.380	.420	3,4
E1	6.22	—	.245	—	4
e	2.54 BSC		.100 BSC		
H	14.61	15.88	.575	.625	
L	1.78	2.79	.070	.110	
L1	—	1.65	—	.066	4
L2	—	1.78	—	.070	
L3	0.25 BSC		.010 BSC		
L4	4.78	5.28	.188	.208	

**LEAD ASSIGNMENTS**

- DIODES**
- 1.- ANODE (TWO DIE) / OPEN (ONE DIE)
  - 4.- CATHODE
  - 3.- ANODE
- HEXFET**
- 1.- GATE
  - 4.- DRAIN
  - 3.- SOURCE
- IGBTs, CoPACK**
- 1.- GATE
  - 4.- COLLECTOR
  - 3.- EMITTER

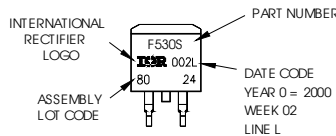
**NOTES:**

1. DIMENSIONING AND TOLERANCING PER ASME Y14.5M-1994
2. DIMENSIONS ARE SHOWN IN MILLIMETERS [INCHES]
3. DIMENSION D & E DO NOT INCLUDE MOLD FLASH. MOLD FLASH SHALL NOT EXCEED 0.127 [0.005] PER SIDE. THESE DIMENSIONS ARE MEASURED AT THE OUTMOST EXTREMES OF THE PLASTIC BODY AT DATUM H.
4. THERMAL PAD CONTOUR OPTIONAL WITHIN DIMENSION E, L1, D1 & E1.
5. DIMENSION b1 AND c1 APPLY TO BASE METAL ONLY.
6. DATUM A & B TO BE DETERMINED AT DATUM PLANE H.
7. CONTROLLING DIMENSION: INCH.
8. OUTLINE CONFORMS TO JEDEC OUTLINE TO-263AB.

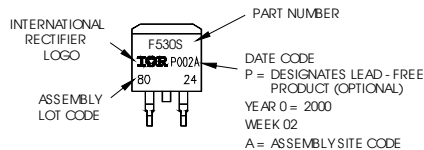
## D<sup>2</sup>Pak (TO-263AB) Part Marking Information

EXAMPLE: THIS IS AN IRF530S WITH  
LOT CODE 8024  
ASSEMBLED ON WW 02, 2000  
IN THE ASSEMBLY LINE "L"

Note: "P" in assembly line position  
indicates "Lead - Free"



OR



**Notes:**

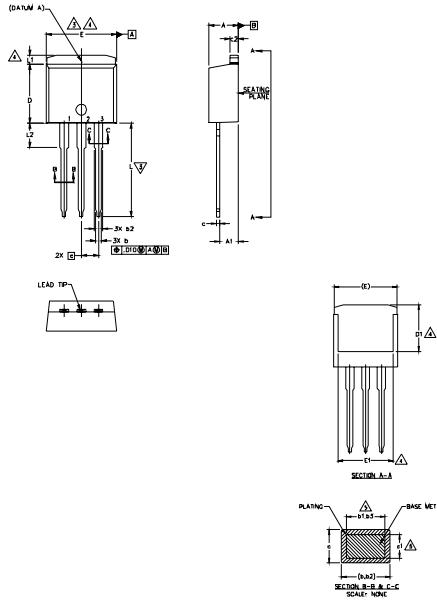
1. For an Automotive Qualified version of this part please see <http://www.irf.com/product-info/autol/>
2. For the most current drawing please refer to IR website at <http://www.irf.com/package/>

# IRF1405S/LPbF



## TO-262 Package Outline

Dimensions are shown in millimeters (inches)



**NOTES:**

1. DIMENSIONING AND TOLERANCING PER ASME Y14.5M-1994
2. DIMENSIONS ARE SHOWN IN MILLIMETERS [INCHES].
3. DIMENSION D & E DO NOT INCLUDE MOLD FLASH. MOLD FLASH SHALL NOT EXCEED 0.127 [0.005"] PER SIDE. THESE DIMENSIONS ARE MEASURED AT THE OUTMOST EXTREMES OF THE PLASTIC BODY.
4. THERMAL PAD CONTOUR OPTIONAL WITHIN DIMENSION E, L1, D1 & E1.
5. DIMENSION b1 AND c1 APPLY TO BASE METAL ONLY.
6. CONTROLLING DIMENSION: INCH.
7. OUTLINE CONFORM TO JEDEC TO-262 EXCEPT A1(max.), b(min.) AND D1(min.) WHERE DIMENSIONS DERIVED THE ACTUAL PACKAGE OUTLINE.

SYMBOL	DIMENSIONS				NOTES
	MILLIMETERS		INCHES		
	MIN.	MAX.	MIN.	MAX.	
A	4.06	4.83	.160	.190	
A1	2.03	3.02	.080	.119	
b	0.51	0.99	.020	.039	5
b1	0.51	0.89	.020	.035	
b2	1.14	1.78	.045	.070	
b3	1.14	1.73	.045	.068	5
c	0.38	0.74	.015	.029	
c1	0.38	0.58	.015	.023	5
c2	1.14	1.65	.045	.065	
D	8.38	9.65	.330	.380	3
D1	6.86	-	.270	-	4
E	9.65	10.67	.380	.420	3,4
E1	6.22	-	.245	-	4
e	2.54 BSC		.100 BSC		
L	13.46	14.10	.530	.555	
L1	-	1.65	-	.065	4
L2	3.56	3.71	.140	.146	

**LEAD ASSIGNMENTS**

**HEXFEEET**

- 1.- GATE
- 2.- DRAIN
- 3.- SOURCE
- 4.- DRAIN

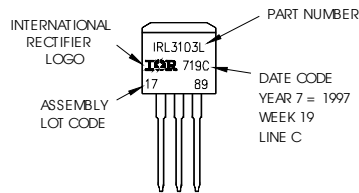
**IGBTs, CoPACK**

- 1.- GATE
- 2.- COLLECTOR
- 3.- EMITTER
- 4.- COLLECTOR

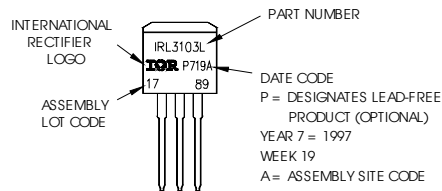
## TO-262 Part Marking Information

EXAMPLE: THIS IS AN IRL3103L  
 LOT CODE 1789  
 ASSEMBLED ON WW 19, 1997  
 IN THE ASSEMBLY LINE "C"

Note: "P" in assembly line position indicates "Lead - Free"



OR

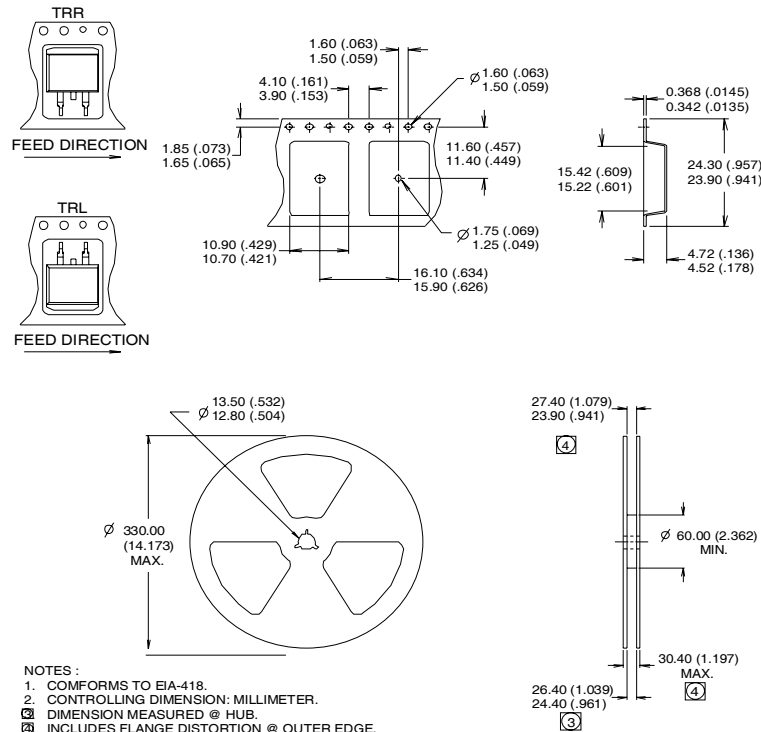


**Notes:**

1. For an Automotive Qualified version of this part please see <http://www.irf.com/product-info/auto/>
2. For the most current drawing please refer to IR website at <http://www.irf.com/package/>

## D<sup>2</sup>Pak Tape & Reel Information

Dimensions are shown in millimeters (inches)



### Notes:

- ① Repetitive rating; pulse width limited by max. junction temperature. (See fig. 11).
- ② Starting  $T_J = 25^\circ\text{C}$ ,  $L = 0.11\text{mH}$   
 $R_G = 25\Omega$ ,  $I_{AS} = 101\text{A}$ . (See Figure 12).
- ③  $I_{SD} \leq 101\text{A}$ ,  $di/dt \leq 210\text{A}/\mu\text{s}$ ,  $V_{DD} \leq V_{(BR)DSS}$ ,  
 $T_J \leq 175^\circ\text{C}$
- ④ Pulse width  $\leq 400\mu\text{s}$ ; duty cycle  $\leq 2\%$ .
- ⑤  $C_{OSS}$  eff. is a fixed capacitance that gives the same charging time as  $C_{OSS}$  while  $V_{DS}$  is rising from 0 to 80%  $V_{DSS}$ .
- ⑥ Calculated continuous current based on maximum allowable junction temperature. Package limitation current is 75A.
- ⑦ Limited by  $T_{Jmax}$ , see Fig.12a, 12b, 15, 16 for typical repetitive avalanche performance.
- ⑧ This is applied to D<sup>2</sup>Pak, when mounted on 1" square PCB ( FR-4 or G-10 Material ).  
 For recommended footprint and soldering techniques refer to application note #AN-994.

Data and specifications subject to change without notice.  
 This product has been designed and qualified for the industrial market.  
 Qualification Standards can be found on IR's Web site.