

STT200GKXXB

Thyristor-Thyristor Modules

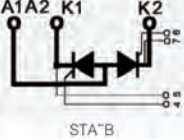

Type	V_{RSM} V_{DSM} V	V_{RRM} V_{DRM} V
STT200GK08B	900	800
STT200GK12B	1300	1200
STT200GK14B	1500	1400
STT200GK16B	1700	1600
STT200GK18B	1900	1800

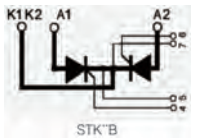
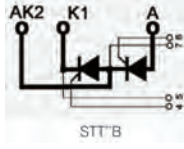
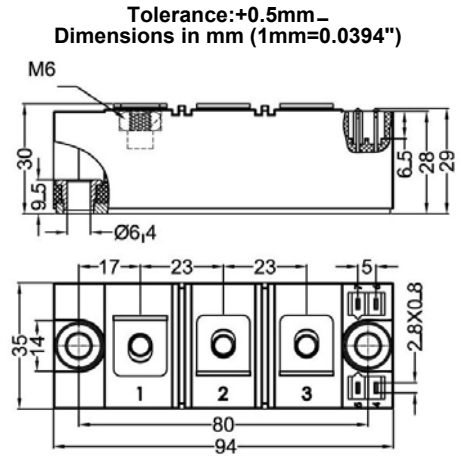

Symbol	Test Conditions	Maximum Ratings	Unit
I_{TRMS}, I_{FRMS} I_{TAVM}, I_{FAVM}	$T_{VJ}=T_{VJM}$ $T_C=85^{\circ}C$; 180° sine	314 200	A
I_{TSM}, I_{FSM}	$T_{VJ}=45^{\circ}C$ $V_R=0$ $t=10ms$ (50Hz), sine $t=8.3ms$ (60Hz), sine	6500 7200	A
	$T_{VJ}=T_{VJM}$ $V_R=0$ $t=10ms$ (50Hz), sine $t=8.3ms$ (60Hz), sine	5500 6100	
$\int i^2 dt$	$T_{VJ}=45^{\circ}C$ $V_R=0$ $t=10ms$ (50Hz), sine $t=8.3ms$ (60Hz), sine	38000 34000	A ² s
	$T_{VJ}=T_{VJM}$ $V_R=0$ $t=10ms$ (50Hz), sine $t=8.3ms$ (60Hz), sine	30000 27000	
$(di/dt)_{cr}$	$T_{VJ}=T_{VJM}$ $f=50Hz, t_p=200\mu s$ $V_D=2/3V_{DRM}$ $I_G=1A$ $di_G/dt=1A/\mu s$	repetitive, $I_T=750A$ 250 non repetitive, $I_T=200A$ 800	A/ μs
	$T_{VJ}=T_{VJM}$; $R_{GK}=\infty$; method 1 (linear voltage rise)	$V_{DR}=2/3V_{DRM}$ 1000	V/ μs
P_{GM}	$T_{VJ}=T_{VJM}$ $I_T=I_{TAVM}$	$t_p=30\mu s$ 120 $t_p=500\mu s$ 60	W
P_{GAV}		20	W
V_{RGM}		10	V
T_{VJ} T_{VJM} T_{stg}		-40...+125 125 -40...+125	°C
V_{ISOL}	50/60Hz, RMS $I_{ISOL} \leq 1mA$	$t=1min$ 3000 $t=1s$ 3600	V~
M_d	Mounting torque (M5)	2.5-5/22-44	Nm/lb.in.
Weight	Typ.	170	g



STT200GKXXB

Thyristor-Thyristor Modules

Symbol	Test Conditions	Characteristic Values	Unit
IRRM	$T_{VJ}=T_{VJM}; V_R=V_{RRM};$	70	mA
IDRM	$T_{VJ}=T_{VJM}; V_D=V_{DRM}$	70	mA
V_T, V_F	$I_T, I_F=600A; T_{VJ}=25^{\circ}C$	1.60	V
V_{TO}	For power-loss calculations only ($T_{VJ}=125^{\circ}C$)	0.95	V
r_T		1.0	mΩ
V_{GT}	$V_D=6V;$ $T_{VJ}=25^{\circ}C$ $T_{VJ}=-40^{\circ}C$	2 3	V
I_{GT}	$V_D=6V;$ $T_{VJ}=25^{\circ}C$ $T_{VJ}=-40^{\circ}C$	150 200	mA
V_{GD}	$T_{VJ}=T_{VJM};$ $V_D=2/3V_{DRM}$	0.25	V
I_{GD}		10	mA
I_L	$T_{VJ}=25^{\circ}C; t_p=30\mu s; V_D=6V$ $I_G=0.45A; di_G/dt=0.45A/\mu s$	300	mA
I_H	$T_{VJ}=25^{\circ}C; V_D=6V; R_{GK}=\infty$	150	mA
t_{gd}	$T_{VJ}=25^{\circ}C; V_D=1/2V_{DRM}$ $I_G=1A; di_G/dt=1A/\mu s$	2	us
t_q	$T_{VJ}=T_{VJM}; I_T=300A; t_p=200\mu s; -di/dt=10A/\mu s$ $V_R=100V; dv/dt=50V/\mu s; V_D=2/3V_{DRM}$	200	us
Q_s	$T_{VJ}=125^{\circ}C; I_T, I_F=400A; -di/dt=50A/\mu s$	760	uC
I_{RM}		275	A
R_{thJC}	per thyristor/diode; DC current per module	0.140 0.070	K/W
R_{thJK}	per thyristor/diode; DC current per module	0.180 0.090	K/W
ds	Creeping distance on surface	12.7	mm
da	Strike distance through air	9.6	mm
a	Maximum allowable acceleration	50	m/s ²

FEATURES

- * International standard package
- * Glass passivated chips
- * Isolation voltage 3600 V~
- * RoHs compliant

APPLICATIONS

- * Motor control
- * Power converter
- * Heat and temperature control for industrial furnaces and chemical processes
- * Lighting control
- * Contactless switches

ADVANTAGES

- * Space and weight savings
- * Simple mounting
- * Improved temperature and power cycling
- * Reduced protection circuits



STT200GKXXB

Thyristor-Thyristor Modules

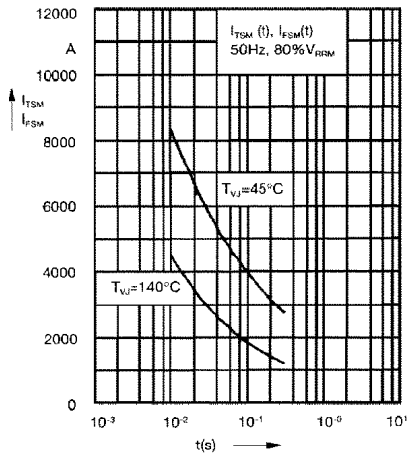

Fig. 1 Surge overload current
 I_{TSM} , I_{FSM} : Crest value, t: duration

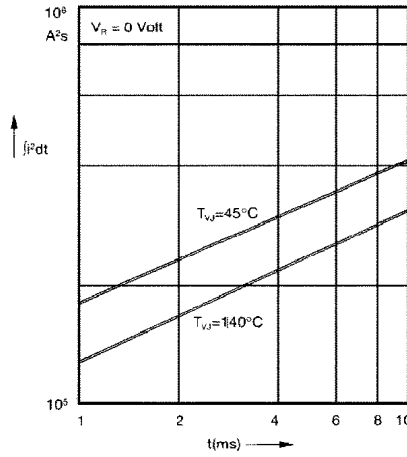

Fig. 2 I^2t versus time (1-10 ms)

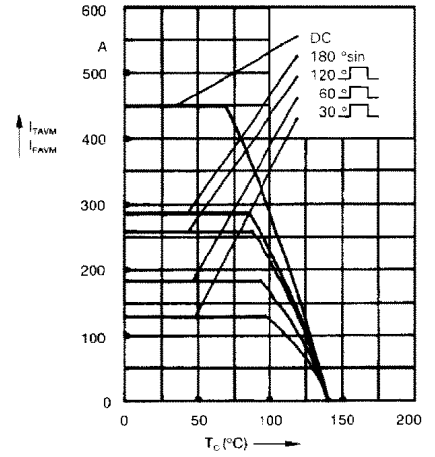

Fig. 2a Maximum forward current at case temperature

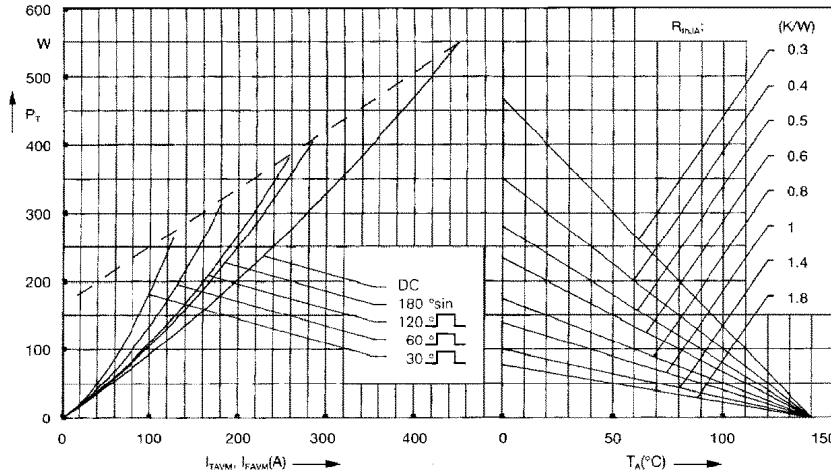

Fig. 3 Power dissipation versus on-state current and ambient temperature (per thyristor or diode)

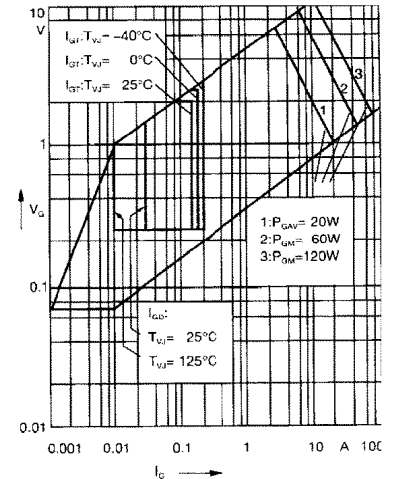

Fig. 4 Gate trigger characteristics

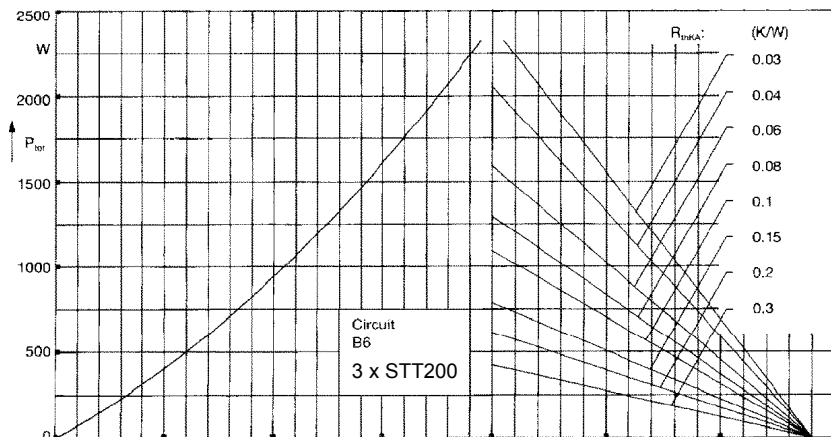

Fig. 5 Three phase rectifier bridge: Power dissipation versus direct output current and ambient temperature

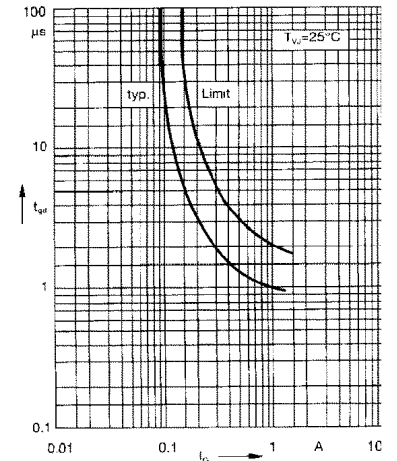

Fig. 6 Gate trigger delay time



STT200GKXXB

Thyristor-Thyristor Modules

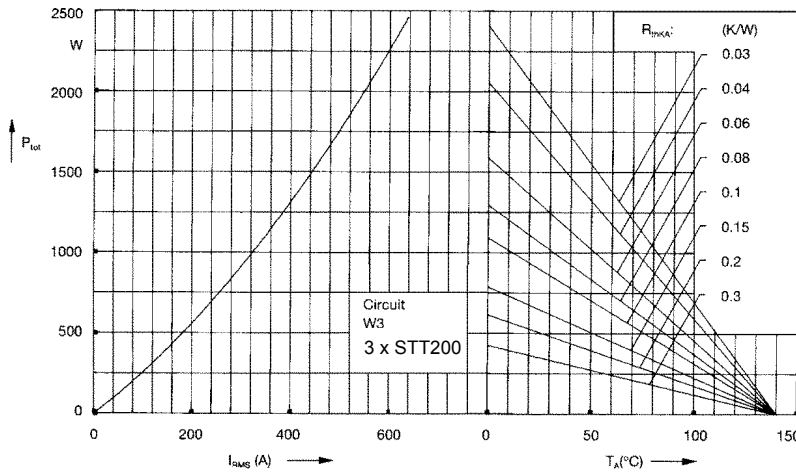

Fig. 7 Three phase AC-controller: Power dissipation versus RMS output current and ambient temperature

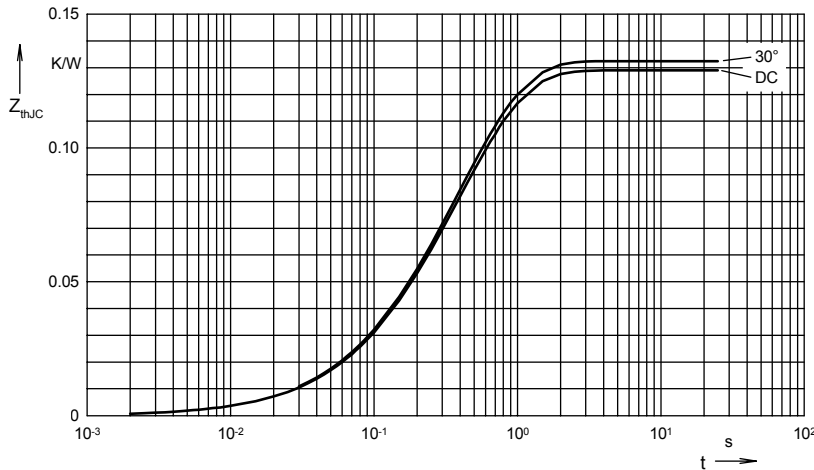

Fig. 8 Transient thermal impedance junction to case (per thyristor or diode)

R_{thJC} for various conduction angles d :

d	R_{thJC} (K/W)
DC	0.129
180°	0.131
120°	0.131
60°	0.132
30°	0.132

Constants for Z_{thJC} calculation:

i	R_{thi} (K/W)	t_i (s)
1	0.0035	0.099
2	0.0165	0.168
3	0.1091	0.456

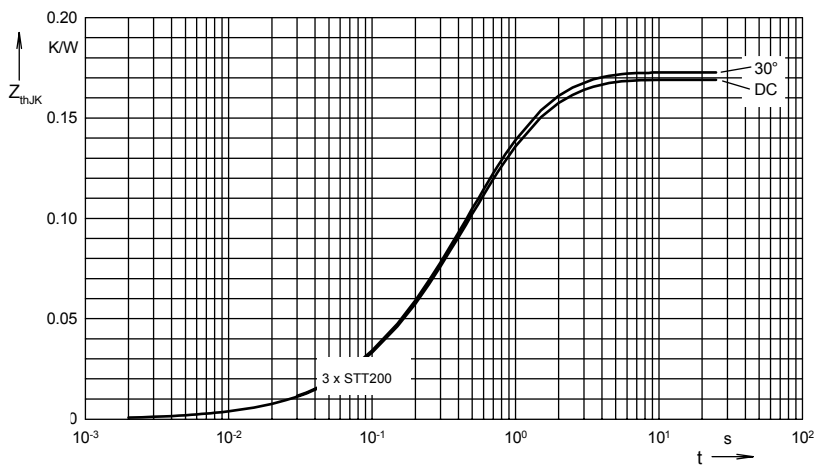

Fig. 9 Transient thermal impedance junction to heatsink (per thyristor or diode)

R_{thJK} for various conduction angles d :

d	R_{thJK} (K/W)
DC	0.169
180°	0.171
120°	0.172
60°	0.172
30°	0.173

Constants for Z_{thJK} calculation:

i	R_{thi} (K/W)	t_i (s)
1	0.0033	0.099
2	0.0159	0.168
3	0.1053	0.456
4	0.04	1.36

