

< HVIGBT MODULES >

CM1000HC-66R

HIGH POWER SWITCHING USE
INSULATED TYPE

4th-Version HVIGBT (High Voltage Insulated Gate Bipolar Transistor) Modules

CM1000HC-66R



- I_C 1000A
- V_{CES} 3300V
- 1-element in a Pack
- Insulated Type
- LPT-IGBT / Soft Recovery Diode
- AISiC Baseplate

APPLICATION

Traction drives, High Reliability Converters / Inverters, DC choppers

OUTLINE DRAWING & CIRCUIT DIAGRAM

Dimensions in mm

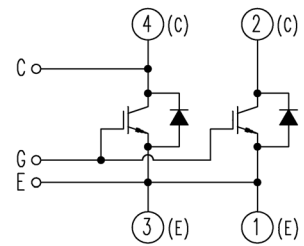
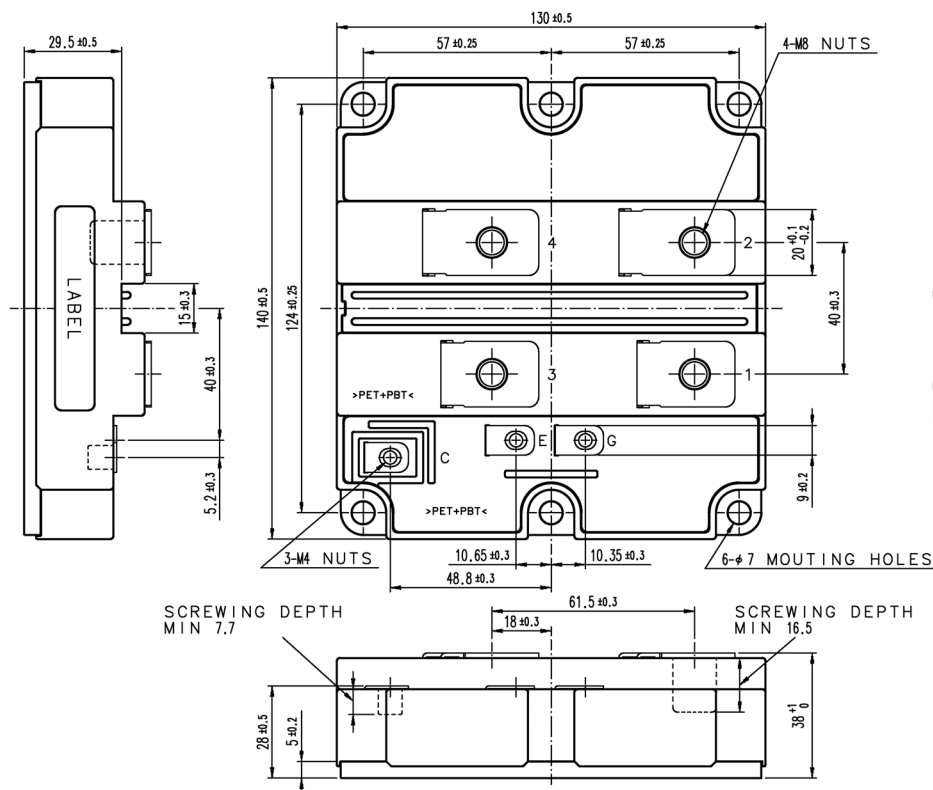

接続図
CIRCUIT DIAGRAM

< HVIGBT MODULES >

CM1000HC-66R

HIGH POWER SWITCHING USE
INSULATED TYPE

4th-Version HVIGBT (High Voltage Insulated Gate Bipolar Transistor) Modules

MAXIMUM RATINGS

Symbol	Item	Conditions	Ratings	Unit
V _{CES}	Collector-emitter voltage	V _{GE} = 0V, T _J = -40...+150°C	3300	V
		V _{GE} = 0V, T _J = -50°C	3200	
V _{GES}	Gate-emitter voltage	V _{CE} = 0V, T _J = 25°C	± 20	V
I _C	Collector current	DC, T _C = 95°C	1000	A
I _{CRM}		Pulse (Note 1)	2000	
I _E	Emitter current (Note 2)	DC	1000	A
I _{ERM}		Pulse (Note 1)	2000	
P _{tot}	Maximum power dissipation (Note 3)	T _C = 25°C, IGBT part	10400	W
V _{iso}	Isolation voltage	RMS, sinusoidal, f = 60Hz, t = 1 min.	6000	V
V _e	Partial discharge extinction voltage	RMS, sinusoidal, f = 60Hz, Q _{PD} ≤ 10 pC	2600	V
T _J	Junction temperature		-50 ~ +150	°C
T _{Jop}	Operating junction temperature		-50 ~ +150	°C
T _{stg}	Storage temperature		-55 ~ +150	°C
t _{psc}	Short circuit pulse width	V _{CC} = 2500V, V _{CE} ≤ V _{CES} , V _{GE} = 15V, T _J = 150°C	10	μs

ELECTRICAL CHARACTERISTICS

Symbol	Item	Conditions	Limits			Unit	
			Min	Typ	Max		
I _{CES}	Collector cutoff current	V _{CE} = V _{CES} , V _{GE} = 0V	T _J = 25°C	—	—	4.0	mA
			T _J = 125°C	—	4.0	—	
			T _J = 150°C	—	24.0	—	
V _{GE(th)}	Gate-emitter threshold voltage	V _{CE} = 10 V, I _C = 100 mA, T _J = 25°C	5.7	6.2	6.7	V	
I _{GES}	Gate leakage current	V _{GE} = V _{GES} , V _{CE} = 0V, T _J = 25°C	-0.5	—	0.5	μA	
C _{ies}	Input capacitance	V _{CE} = 10 V, V _{GE} = 0 V, f = 100 kHz T _J = 25°C	—	140.0	—	nF	
C _{oes}	Output capacitance		—	8.7	—	nF	
C _{res}	Reverse transfer capacitance		—	4.0	—	nF	
Q _G	Total gate charge	V _{CC} = 1800V, I _C = 1000A, V _{GE} = ±15V	—	10.7	—	μC	
V _{CESat}	Collector-emitter saturation voltage	I _C = 1000 A (Note 4) V _{GE} = 15 V	T _J = 25°C	—	2.45	—	V
			T _J = 125°C	—	3.10	3.70	
			T _J = 150°C	—	3.25	—	
t _{d(on)}	Turn-on delay time	V _{CC} = 1800 V I _C = 1000 A V _{GE} = ±15 V	T _J = 25°C	—	1.00	—	μs
			T _J = 125°C	—	0.95	1.25	
			T _J = 150°C	—	0.95	1.25	
t _r	Turn-on rise time	R _{G(on)} = 2.4 Ω L _s = 150 nH Inductive load	T _J = 25°C	—	0.28	—	μs
			T _J = 125°C	—	0.30	0.50	
			T _J = 150°C	—	0.30	0.50	
E _{on(10%)}	Turn-on switching energy (Note 5)	Inductive load	T _J = 25°C	—	1.40	—	J
			T _J = 125°C	—	1.85	—	
			T _J = 150°C	—	2.00	—	
E _{on}	Turn-on switching energy (Note 6)	Inductive load	T _J = 25°C	—	1.50	—	J
			T _J = 125°C	—	1.95	—	
			T _J = 150°C	—	2.15	—	
t _{d(off)}	Turn-off delay time	V _{CC} = 1800 V I _C = 1000 A V _{GE} = ±15 V	T _J = 25°C	—	2.70	—	μs
			T _J = 125°C	—	2.80	3.30	
			T _J = 150°C	—	2.85	3.30	
t _f	Turn-off fall time	R _{G(off)} = 8.4 Ω L _s = 150 nH Inductive load	T _J = 25°C	—	0.30	—	μs
			T _J = 125°C	—	0.35	1.00	
			T _J = 150°C	—	0.40	1.00	
E _{off(10%)}	Turn-off switching energy (Note 5)	Inductive load	T _J = 25°C	—	1.35	—	J
			T _J = 125°C	—	1.65	—	
			T _J = 150°C	—	1.70	—	
E _{off}	Turn-off switching energy (Note 6)	Inductive load	T _J = 25°C	—	1.50	—	J
			T _J = 125°C	—	1.80	—	
			T _J = 150°C	—	1.90	—	

ELECTRICAL CHARACTERISTICS (continuation)

Symbol	Item	Conditions	Limits			Unit	
			Min	Typ	Max		
V_{EC}	Emitter-collector voltage (Note 2)	$I_E = 1000 \text{ A}$ (Note 4) $V_{GE} = 0 \text{ V}$	$T_j = 25^\circ\text{C}$	—	2.15	—	V
			$T_j = 125^\circ\text{C}$	—	2.30	2.80	
			$T_j = 150^\circ\text{C}$	—	2.25	—	
t_{rr}	Reverse recovery time (Note 2)		$T_j = 25^\circ\text{C}$	—	0.50	—	μs
			$T_j = 125^\circ\text{C}$	—	0.70	—	
			$T_j = 150^\circ\text{C}$	—	0.80	—	
I_{rr}	Reverse recovery current (Note 2)	$V_{CC} = 1800 \text{ V}$ $I_C = 1000 \text{ A}$ $V_{GE} = \pm 15 \text{ V}$ $R_{G(on)} = 2.4 \Omega$ $L_S = 150 \text{ nH}$ Inductive load	$T_j = 25^\circ\text{C}$	—	850	—	A
			$T_j = 125^\circ\text{C}$	—	1000	—	
			$T_j = 150^\circ\text{C}$	—	1050	—	
Q_{rr}	Reverse recovery charge (Note 2)		$T_j = 25^\circ\text{C}$	—	700	—	μC
			$T_j = 125^\circ\text{C}$	—	1150	—	
			$T_j = 150^\circ\text{C}$	—	1350	—	
$E_{rec(10\%)}$	Reverse recovery energy (Note 2) (Note 5)		$T_j = 25^\circ\text{C}$	—	0.70	—	J
			$T_j = 125^\circ\text{C}$	—	1.20	—	
			$T_j = 150^\circ\text{C}$	—	1.35	—	
E_{rec}	Reverse recovery energy (Note 2) (Note 6)		$T_j = 25^\circ\text{C}$	—	0.80	—	J
			$T_j = 125^\circ\text{C}$	—	1.35	—	
			$T_j = 150^\circ\text{C}$	—	1.55	—	

THERMAL CHARACTERISTICS

Symbol	Item	Conditions	Limits			Unit
			Min	Typ	Max	
$R_{th(j-c)Q}$	Thermal resistance	Junction to Case, IGBT part	—	—	12.0	K/kW
$R_{th(j-c)D}$		Junction to Case, FWDi part	—	—	22.5	K/kW
$R_{th(c-s)}$	Contact thermal resistance	Case to heat sink, $\lambda_{grease} = 1\text{W/m}^2\text{K}$, $D_{(c-s)} = 100\mu\text{m}$	—	9.0	—	K/kW

MECHANICAL CHARACTERISTICS

Symbol	Item	Conditions	Limits			Unit
			Min	Typ	Max	
M_t	Mounting torque	M8 : Main terminals screw	7.0	—	22.0	N·m
M_s		M6 : Mounting screw	3.0	—	6.0	N·m
M_t		M4 : Auxiliary terminals screw	1.0	—	3.0	N·m
m	Mass		—	0.8	—	kg
CTI	Comparative tracking index		600	—	—	—
d_a	Clearance		19.5	—	—	mm
d_s	Creepage distance		32.0	—	—	mm
L_{PCE}	Parasitic stray inductance		—	16.5	—	nH
R_{CC+EE}	Internal lead resistance	$T_C = 25^\circ\text{C}$	—	0.18	—	m Ω
r_g	Internal gate resistance	$T_C = 25^\circ\text{C}$	—	2.25	—	Ω

Note1. Pulse width and repetition rate should be such that junction temperature (T_j) does not exceed T_{opmax} rating(150°C).

- The symbols represent characteristics of the anti-parallel, emitter to collector free-wheel diode (FWD).
- Junction temperature (T_j) should not exceed T_{jmax} rating (150°C).
- Pulse width and repetition rate should be such as to cause negligible temperature rise.
- $E_{on(10\%)}$ / $E_{off(10\%)}$ / $E_{rec(10\%)}$ are the integral of $0.1V_{CE} \times 0.1I_C \times dt$.
- Definition of all items is according to IEC 60747, unless otherwise specified.

PERFORMANCE CURVES

OUTPUT CHARACTERISTICS (TYPICAL)

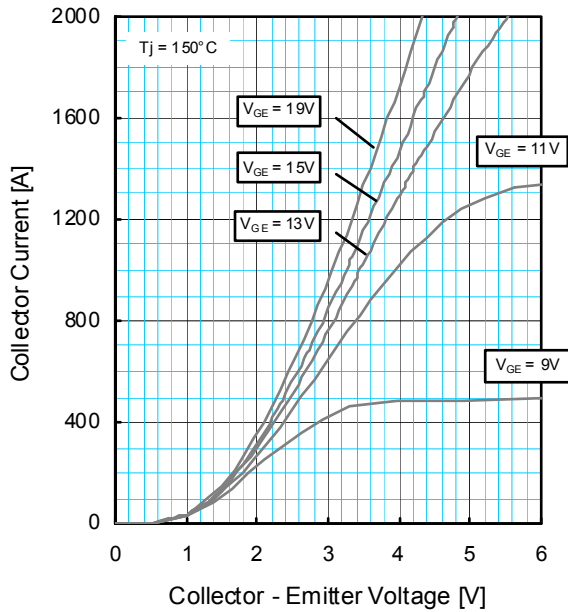

TRANSFER CHARACTERISTICS (TYPICAL)

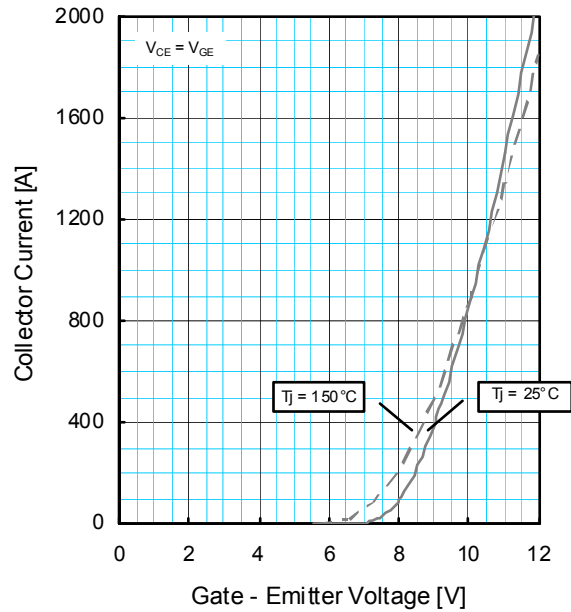

COLLECTOR-EMITTER SATURATION VOLTAGE CHARACTERISTICS (TYPICAL)

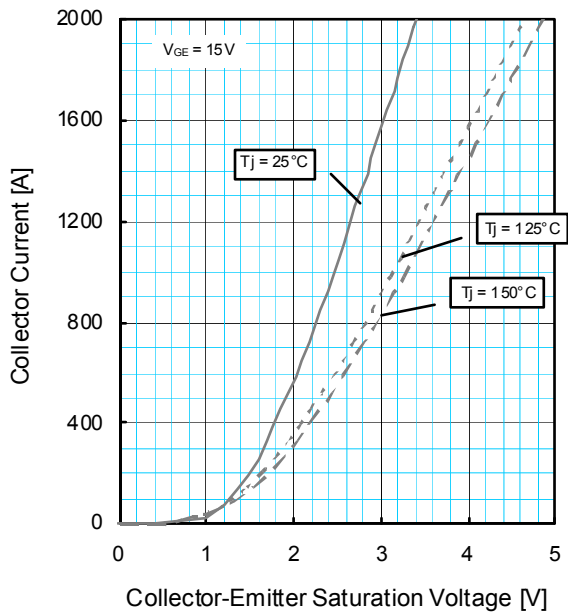

FREE-WHEEL DIODE FORWARD CHARACTERISTICS (TYPICAL)

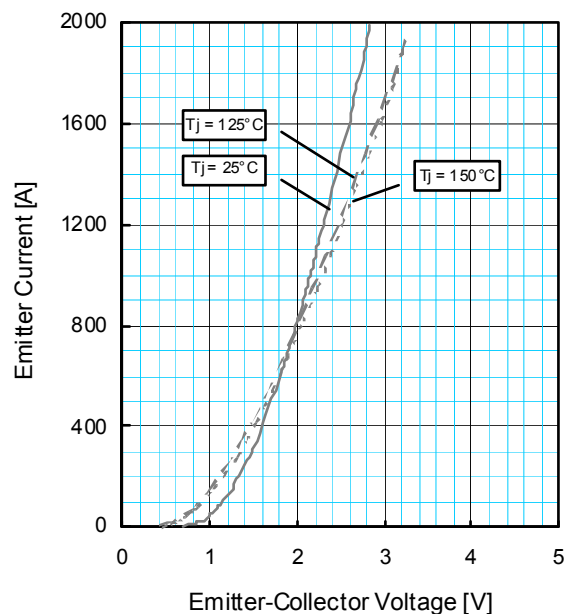

PERFORMANCE CURVES

CAPACITANCE CHARACTERISTICS (TYPICAL)

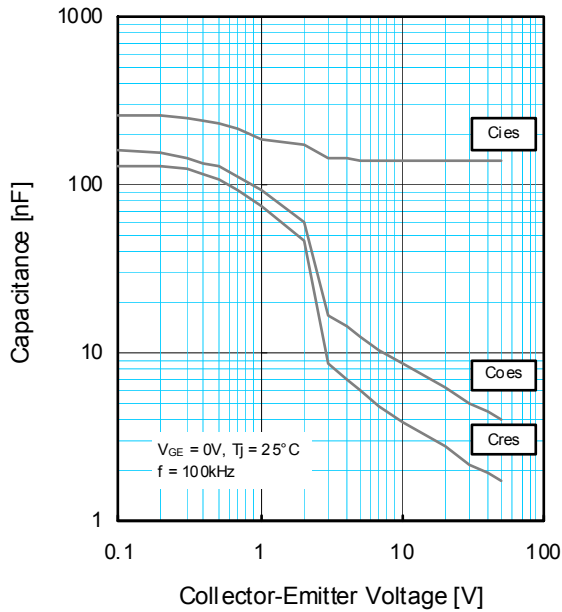

GATE CHARGE CHARACTERISTICS (TYPICAL)

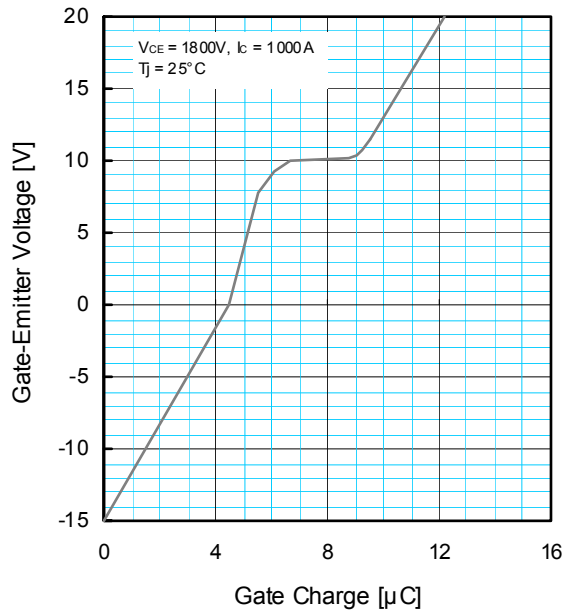

HALF-BRIDGE SWITCHING ENERGY CHARACTERISTICS (TYPICAL)

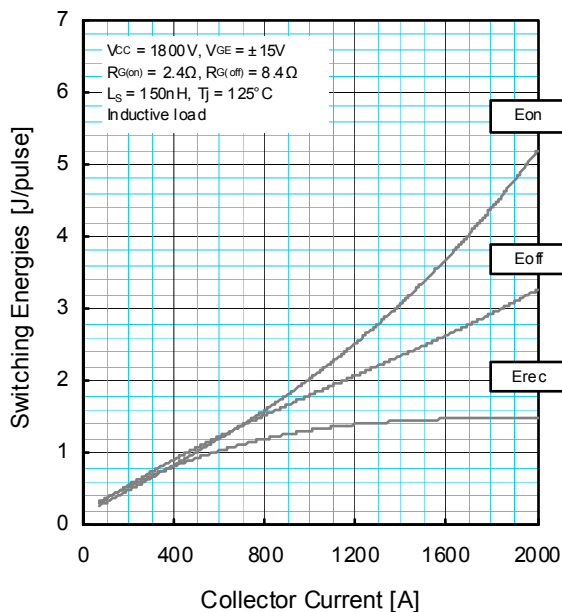

HALF-BRIDGE SWITCHING ENERGY CHARACTERISTICS (TYPICAL)

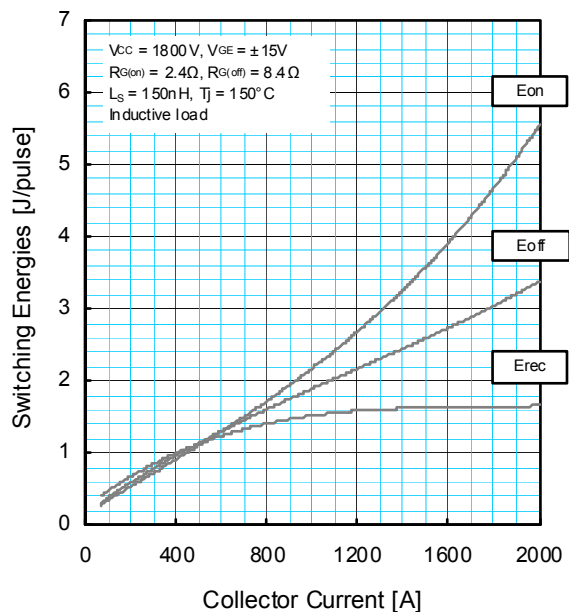

PERFORMANCE CURVES

HALF-BRIDGE SWITCHING ENERGY CHARACTERISTICS (TYPICAL)

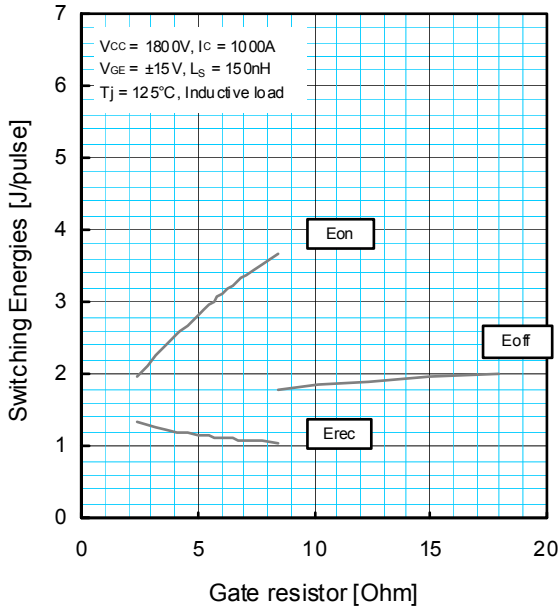

HALF-BRIDGE SWITCHING ENERGY CHARACTERISTICS (TYPICAL)

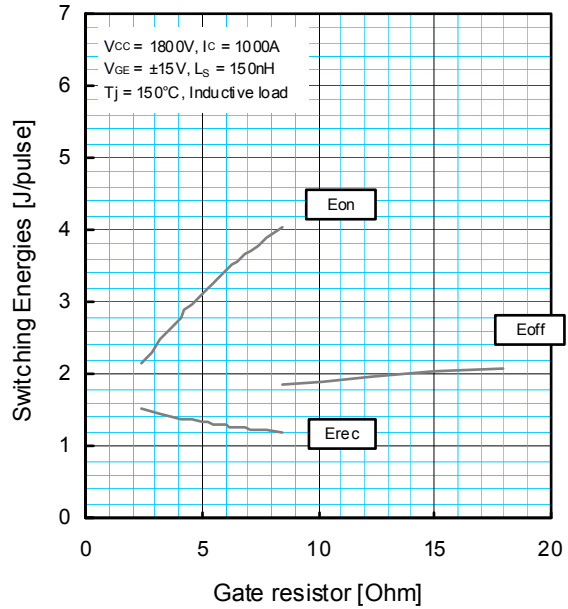

HALF-BRIDGE SWITCHING TIME CHARACTERISTICS (TYPICAL)

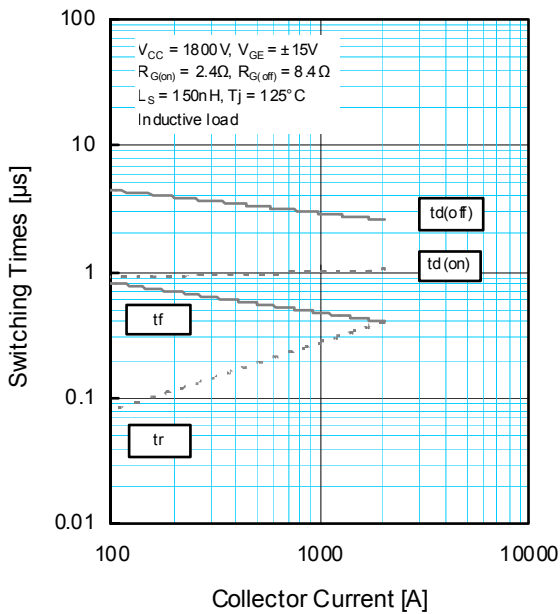

HALF-BRIDGE SWITCHING TIME CHARACTERISTICS (TYPICAL)

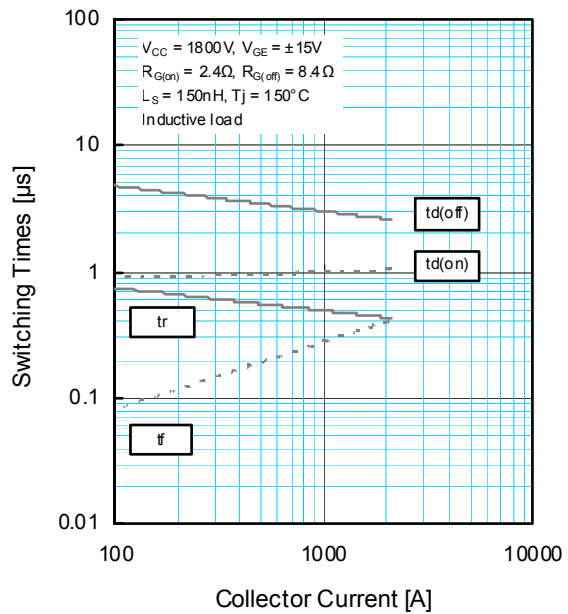

PERFORMANCE CURVES

FREE-WHEEL DIODE REVERSE RECOVERY CHARACTERISTICS (TYPICAL)

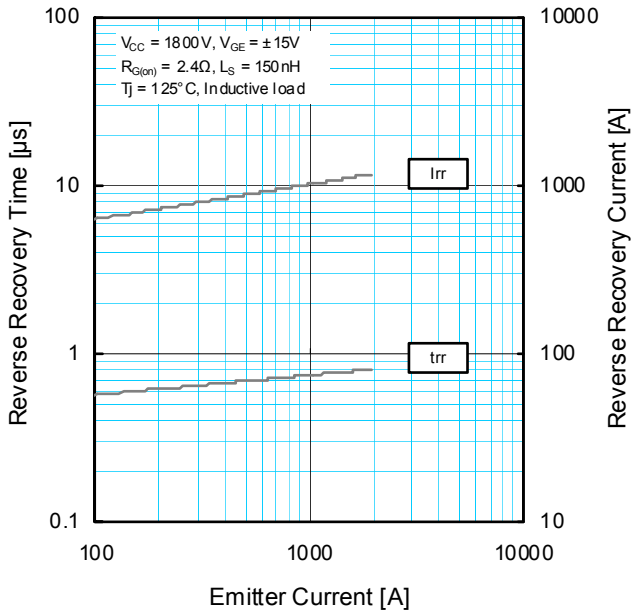

FREE-WHEEL DIODE REVERSE RECOVERY CHARACTERISTICS (TYPICAL)

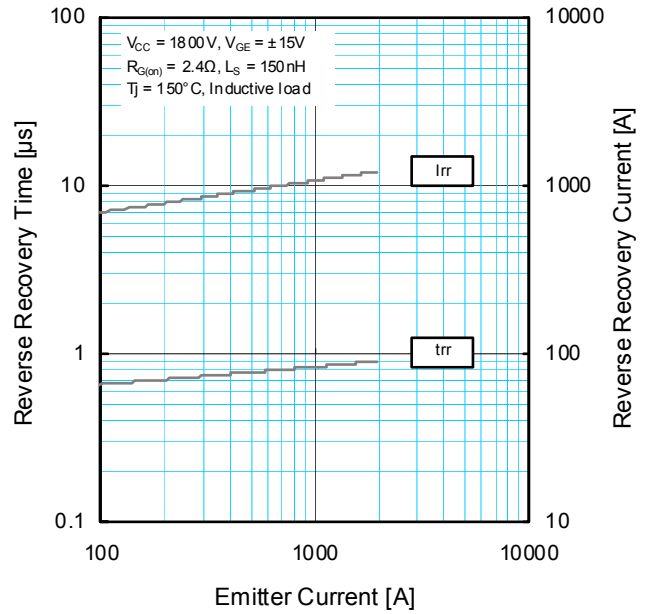

TRANSIENT THERMAL IMPEDANCE CHARACTERISTICS

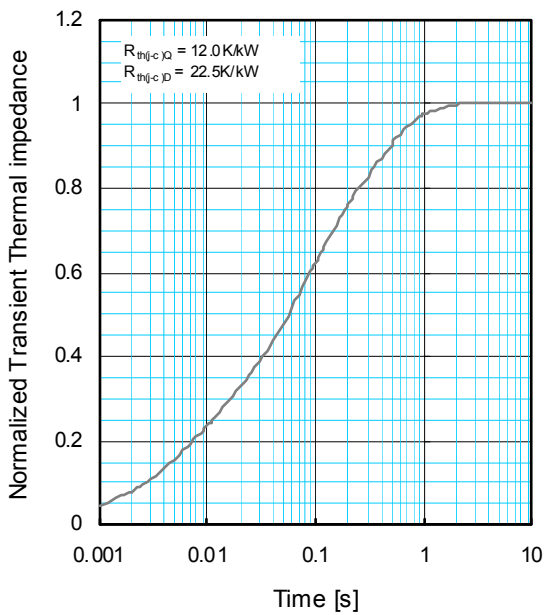

$$Z_{th(j-c)}(t) = \sum_{i=1}^n R_i \left\{ 1 - \exp\left(-\frac{t}{\tau_i}\right) \right\}$$

	1	2	3	4
R_i [K/kW] :	0.0096	0.1893	0.4044	0.3967
τ_i [sec] :	0.0001	0.0058	0.0602	0.3512

PERFORMANCE CURVES

REVERSE BIAS SAFE OPERATING AREA (RBSOA)

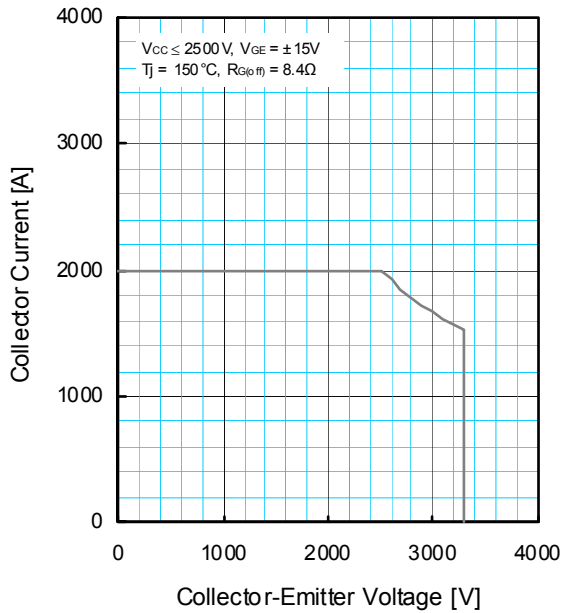

SHORT CIRCUIT SAFE OPERATING AREA (SCSOA)

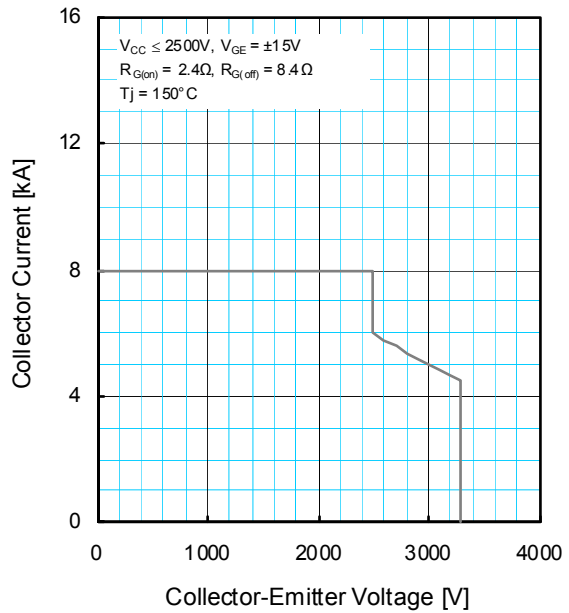

FREE-WHEEL DIODE REVERSE RECOVERY SAFE OPERATING AREA (RRSOA)

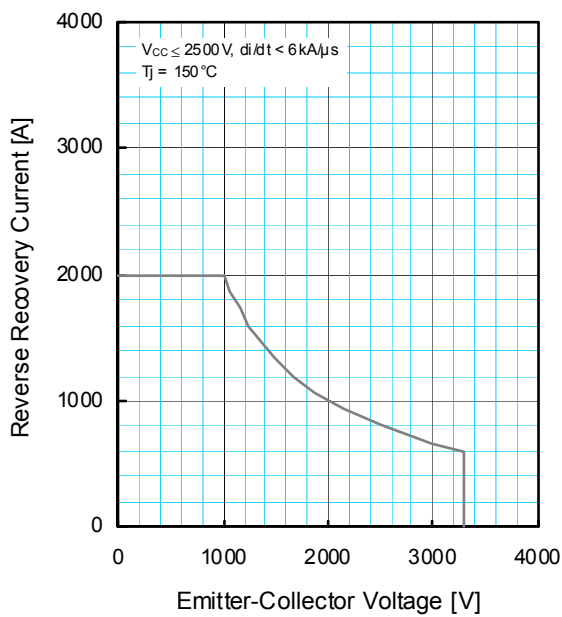

Keep safety first in your circuit designs!

Mitsubishi Electric Corporation puts the maximum effort into making semiconductor products better and more reliable, but there is always the possibility that trouble may occur with them. Trouble with semiconductors may lead to personal injury, fire or property damage. Remember to give due consideration to safety when making your circuit designs, with appropriate measures such as (i) placement of substitutive, auxiliary circuits, (ii) use of non-flammable material or (iii) prevention against any malfunction or mishap.

Notes regarding these materials

- These materials are intended as a reference to assist our customers in the selection of the Mitsubishi semiconductor product best suited to the customer's application; they do not convey any license under any intellectual property rights, or any other rights, belonging to Mitsubishi Electric Corporation or a third party.
- Mitsubishi Electric Corporation assumes no responsibility for any damage, or infringement of any third-party's rights, originating in the use of any product data, diagrams, charts, programs, algorithms, or circuit application examples contained in these materials.
- All information contained in these materials, including product data, diagrams, charts, programs and algorithms represents information on products at the time of publication of these materials, and are subject to change by Mitsubishi Electric Corporation without notice due to product improvements or other reasons. It is therefore recommended that customers contact Mitsubishi Electric Corporation or an authorized Mitsubishi Semiconductor product distributor for the latest product information before purchasing a product listed herein.
The information described here may contain technical inaccuracies or typographical errors. Mitsubishi Electric Corporation assumes no responsibility for any damage, liability, or other loss rising from these inaccuracies or errors.
Please also pay attention to information published by Mitsubishi Electric Corporation by various means, including the Mitsubishi Semiconductor home page (<http://www.MitsubishiElectric.com/>).
- When using any or all of the information contained in these materials, including product data, diagrams, charts, programs, and algorithms, please be sure to evaluate all information as a total system before making a final decision on the applicability of the information and products. Mitsubishi Electric Corporation assumes no responsibility for any damage, liability or other loss resulting from the information contained herein.
- Mitsubishi Electric Corporation semiconductors are not designed or manufactured for use in a device or system that is used under circumstances in which human life is potentially at stake. Please contact Mitsubishi Electric Corporation or an authorized Mitsubishi Semiconductor product distributor when considering the use of a product contained herein for any specific purposes, such as apparatus or systems for transportation, vehicular, medical, aerospace, nuclear, or undersea repeater use.
- The prior written approval of Mitsubishi Electric Corporation is necessary to reprint or reproduce in whole or in part these materials.
- If these products or technologies are subject to the Japanese export control restrictions, they must be exported under a license from the Japanese government and cannot be imported into a country other than the approved destination.
Any diversion or re-export contrary to the export control laws and regulations of Japan and/or the country of destination is prohibited.
- Please contact Mitsubishi Electric Corporation or an authorized Mitsubishi Semiconductor product distributor for further details on these materials or the products contained therein.