



# MAX17019N Evaluation Kit

Evaluates: MAX17019

## General Description

The MAX17019N evaluation kit (EV kit) demonstrates the MAX17019's standard application circuit. This quad-output converter steps down high-voltage batteries and/or AC adapters, generating main supplies for ultra-mobile PCs (UMPCs).

The EV kit provides a 5V main stage output voltage (VOUTA), a 1.8V VDDQ output voltage (VOUTB), a 1.05V chipset supply output voltage (VOUTC), and a 0.9V VTT output voltage (VOUTD) from a 6V to 38V battery input range. It delivers up to 4A output current for the 5V output, 2.5A for the 1.8V output, 4A for the 1.05V output, and 2A for the 0.9V output. The 1.8V VDDQ and 0.9V VTT are for DDR2 memory applications. All outputs are adjustable by changing feedback resistors R5–R10.

The IC also has an internal fixed 5V linear regulator capable of supplying 50mA. The EV kit operates at 0.5MHz (VOUTA and VOUTC) and at 1MHz switching frequency (VOUTB). The EV kit has superior line- and load-transient response.

This EV kit is a fully assembled and tested circuit board. It also allows the evaluation of other fixed output voltages by changing R5–R10 resistors.

## Features

- ◆ 6V to 38V Input Range
- ◆ Internal 5V Linear Regulator with 50mA Load Capability
- ◆ Output Voltages
  - VOUTA: 5V Up to 4A  
(Adjustable from 1V to 5.3V)
  - VOUTB: 1.8V Up to 2.5A  
(Adjustable from 0.75V to 4V)
  - VOUTC: 1.05V Up to 4A  
(Adjustable from 0.75V to 4V)
  - VOUTD: 0.9V Up to 2A  
(Adjustable from 0.5V to 2V)
- ◆ 0.5MHz Switching Frequency (5V and 1.05V Outputs)
- ◆ 1MHz Switching Frequency (1.8V Output)
- ◆ Independent Enable Inputs and Power-Good Outputs
- ◆ Overvoltage and Undervoltage Fault Protection
- ◆ Thermal Fault Protection
- ◆ Proven PCB Layout
- ◆ Fully Assembled and Tested

## Ordering Information

| PART            | TYPE   |
|-----------------|--------|
| MAX17019NEVKIT+ | EV Kit |

+Denotes lead(Pb)-free and RoHS compliant.

## Component List

| DESIGNATION       | QTY | DESCRIPTION   |
|-------------------|-----|---|
| C1, C2            | 2   | 4.7 $\mu$ F $\pm$ 10%, 50V X7R ceramic capacitors (1210)<br>Murata GRM32ER71H475K<br>AVX 12105C475KAT2A |
| C3                | 1   | 22 $\mu$ F, 50V aluminum electrolytic capacitor (6.3mm x 6.0mm DxL)<br>SANYO 50CE22KX                   |
| C4, C11, C20, C24 | 4   | 4.7 $\mu$ F $\pm$ 10% 6.3V X5R ceramic capacitors (0603)<br>Murata GRM188R60J475K<br>TDK C1608X5R0J475K |

| DESIGNATION       | QTY | DESCRIPTION   |
|-------------------|-----|---|
| C5, C25, C33      | 3   | 1 $\mu$ F $\pm$ 10%, 6.3V X5R ceramic capacitors (0402)<br>Murata GRM155R60J105K<br>TDK C1005X5R0J105K  |
| C6                | 1   | 1 $\mu$ F $\pm$ 10%, 50V X7R ceramic capacitor (0805)<br>Murata GRM21BR71H105K                          |
| C7, C17, C21, C29 | 4   | 0.1 $\mu$ F $\pm$ 10%, 10V X5R ceramic capacitors (0402)<br>Murata GRM155R60J104K<br>TDK C1005X5R1A104K |



# MAX17019N Evaluation Kit

Evaluates: MAX17019

## Component List (continued)

| DESIGNATION   | QTY | DESCRIPTION   |
|---------------|-----|---|
| C9            | 1   | 150 $\mu$ F, 6.3V low-ESR capacitor (B case)<br>SANYO 6TPE150MAZB<br>NEC TOKIN PSLBOJ157M(35)           |
| C10, C32, C35 | 0   | Not installed, capacitors (B case)  |
| C14           | 1   | 680pF $\pm$ 10%, 50V X7R ceramic capacitor (0402)<br>Murata GRM155R71H681K<br>TDK C1005X7R1H681K        |
| C15, C36, C37 | 0   | Not installed, capacitors (0805)  |
| C16, C26, C34 | 3   | 10 $\mu$ F $\pm$ 20%, 6.3V X5R ceramic capacitors (0805)<br>Murata GRM21BR60J106M<br>TDK C2012X5R0J106M |
| C18, C30      | 2   | 1000pF $\pm$ 10%, 50V X7R ceramic capacitors (0402)<br>Murata GRM155R71H102K<br>TDK C1005X7R1H102K      |
| C19, C22      | 2   | 330 $\mu$ F, 2.5V low-ESR capacitors (B case)<br>SANYO 2TPE330MAFGB<br>NEC TOKIN PSLB20E337M(18)        |
| C23           | 1   | 2200pF $\pm$ 10%, 50V X7R ceramic capacitor (0402)<br>Murata GRM155R71H222K<br>TDK C1005X7R1H222K       |
| C27, C28      | 2   | 22 $\mu$ F, 6.3V X5R ceramic capacitors (0805)<br>TDK C2012X5R0J226MT<br>Taiyo Yuden JMK212BJ226MG      |
| C31           | 1   | 0.22 $\mu$ F $\pm$ 10%, 10V X5R ceramic capacitor (0402)<br>Murata GRM155R60J224K<br>TDK C1005X5R0J224K |

| DESIGNATION                   | QTY | DESCRIPTION  |
|-------------------------------|-----|--|
| D1                            | 1   | 250mA, 50V Schottky diode (SOT323)<br>Central Semi CMSSH-3E  |
| L1                            | 1   | 4.7 $\mu$ H, 7A, 20m $\Omega$ inductor (7mm x 7mm x 4mm)<br>Würth 744311470                                      |
| L2, L3                        | 2   | 1 $\mu$ H, 6.8A, 14.2m $\Omega$ inductors (5.8mm x 6.2mm x 3.0mm)<br>NEC TOKIN MPLC0525L1R0<br>TOKO FDV0530-1R0M |
| N1-A, N1-B                    | 1   | Dual n-channel MOSFETs (8 SO)<br>Fairchild FDS6982AS   |
| POKA-POKD, REFIND, SYNC, VTTR | 7   | Test points  |
| R1                            | 1   | 10 $\Omega$ $\pm$ 5% resistor (0402)   |
| R2, R21                       | 2   | 0 $\Omega$ $\pm$ 5% resistors (0402)   |
| R3, R4, R20, R24, R29         | 0   | Not installed, resistors (0402)  |
| R5                            | 1   | 40.2k $\Omega$ $\pm$ 1% resistor (0402)  |
| R6, R8, R10, R22, R23         | 5   | 10k $\Omega$ $\pm$ 1% resistors (0402)   |
| R7                            | 1   | 14k $\Omega$ $\pm$ 1% resistor (0402)  |
| R9                            | 1   | 4.02k $\Omega$ $\pm$ 1% resistor (0402)  |
| R11-R19                       | 9   | 100k $\Omega$ $\pm$ 5% resistors (0402)  |
| R25                           | 1   | 51 $\Omega$ $\pm$ 5% resistor (0402)   |
| R26                           | 1   | 0.004 $\Omega$ $\pm$ 1%, 1/4W resistor (1206)<br>Vishay (Dale) WSL12064L000FEA                                   |
| R27, R28                      | 0   | Not installed, resistors—short (PC trace) (0612)   |
| SW1                           | 1   | 5-position, low-profile DIP switch<br>ITT SD05H0SB or Equivalent   |
| U1                            | 1   | Quad output controller (48 TQFN-EP)<br>Maxim MAX17019ATM+  |
| —                             | 1   | PCB: MAX17019N EVALUATION KIT+   |

# MAX17019N Evaluation Kit

## Component Suppliers

| SUPPLIER                       | PHONE        | WEBSITE                  |
|--------------------------------|--------------|--------------------------|
| AVX Corporation                | 843-946-0238 | www.avx.com              |
| Central Semiconductor Corp.    | 631-435-1110 | www.centrasemi.com       |
| Fairchild Semiconductor        | 888-522-5372 | www.fairchildsemi.com    |
| Murata Manufacturing Co., Ltd. | 770-436-1300 | www.murata.com           |
| NEC TOKIN America, Inc.        | 408-324-1790 | www.nec-tokinamerica.com |
| SANYO Electric Company, Ltd.   | 619-661-6835 | www.sanyodevice.com      |
| Taiyo Yuden                    | 800-348-2496 | www.t-yuden.com          |
| TDK Corp.                      | 847-803-6100 | www.component.tdk.com    |
| TOKO America, Inc.             | 847-297-0070 | www.tokoam.com           |
| Vishay                         | 402-564-3131 | www.vishay.com           |
| Würth Elektronik GmbH & Co. KG | 201-785-8800 | www.we-online.com        |

**Note:** Indicate that you are using the MAX17019 when contacting these component suppliers.

### Quick Start

#### Required Equipment

- MAX17019N EV kit
- 6V to 38V, 100W DC power supply
- Four dummy loads capable of sinking 4A each
- Four digital multimeters
- 100MHz dual-trace oscilloscope

#### Procedure

The EV kit is a fully assembled and tested surface-mount board. Follow the steps below to verify board operation.

**Caution: Do not turn on the power supply until all connections are completed.**

- 1) Ensure that the circuit is connected correctly to the power supply and dummy loads prior to applying any power.
- 2) Set SW1 (1, 10) to the on position ( $\overline{\text{SHDN}} = \text{VBATT}$ , IC enabled).  
Set SW1 (2, 9) to the on position (ONA = VDD, VOUTA enabled).  
Set SW1 (3, 8) to the on position (ONB = VDD, VOUTB enabled).  
Set SW1 (4, 7) to the on position (ONC = VDD, VOUTC enabled).  
Set SW1 (5, 6) to the on position (OND = VDD, VOUTD enabled).

- 3) Connect the first DMM across the VOUTA and GND PCB pads.

Connect the second DMM across the VOUTB and GND PCB pads.

Connect the third DMM across the VOUTC and GND PCB pads.

Connect the fourth DMM across the VOUTD and GND PCB pads.

- 4) Turn on the power supply and adjust the input voltage to 12V.
- 5) Verify that the output voltages are VOUTA = 5V, VOUTB = 1.8V, VOUTC = 1.05V, and VOUTD = 0.9V.

### Detailed Description of Hardware

#### 5V Output-Voltage Setting (VOUTA)

The MAX17019N EV kit is shipped with FBA connected to resistors R5 and R6, which sets the VOUTA voltage to 5V.

To change the output voltage to a value between 1V and 5.3V, remove R5. Calculate R5 using the following equation:

$$R5 = R6 [(VOUTA/VFBA) - 1]$$

where VFBA = 1V and R6 = 10kΩ ±1%. For an output voltage of 1V, place a short across R5 and leave R6 open.

Evaluates: MAX17019

# MAX17019N Evaluation Kit

## 1.8V Output-Voltage Setting (VOUTB)

The EV kit is shipped with FBB connected to resistors R7 and R8, which sets the VOUTB voltage to 1.8V.

To change the output voltage to a value between 0.75V and 4V, remove R7. Calculate R7 using the following equation:

$$R7 = R8 [(VOUTB/VFBB) - 1]$$

where VFBB = 0.75V and R8 = 10kΩ ±1%. For an output voltage of 0.75V, place a short across R7 and leave R8 open.

## 1.05V Output-Voltage Setting (VOUTC)

The EV kit is shipped with FBC connected to resistors R9 and R10, which sets the VOUTC voltage to 1.05V.

To change the output voltage to a value between 0.75V and 4V, remove R9. Calculate R9 using the following equation:

$$R9 = R10 [(VOUTC/VFBC) - 1]$$

where VFBC = 0.75V and R10 = 10kΩ ±1%. For an output voltage of 0.75V, place a short across R9 and leave R10 open.

## 0.9V Output-Voltage Setting (VOUTD)

The EV kit is shipped with FBD connected directly to output voltage VOUTD. The voltage at FBD tracks the REFIND voltage. The REFIND voltage is set to 0.9V (half the output voltage at VOUTB) by resistor-divider R22 and R23.

To change the VOUTD output voltage to a value between 0.5V and 2V, remove R22. Calculate R22 using the following equation:

$$R22 = R23 [(VOUTB/VOUTD) - 1]$$

where R23 = 10kΩ ±1%.

## Frequency Selection (FREQ)

The switching frequency of the EV kit can be adjusted by removing resistor R24 and installing a short across resistors R20 or R21. As configured, the EV kit operates at 0.5MHz (VOUTA and VOUTC) and at 1MHz switching frequency (VOUTB). When changing the switching frequency, refer to the MAX17019 IC data sheet for the proper component selections and calculations for the inductors and output capacitors.

**Table 1. Switch SW1 Settings**

| SW1   |     | PIN CONTROL  | IC OUTPUT  |
|-------|-----|--|--|
| SW1-A | Off | $\overline{\text{SHDN}}$ pin is connected to GND   | Shutdown mode (all outputs disabled)                     |
|       | On  | $\overline{\text{SHDN}}$ pin is connected to VBATT | IC enabled (all outputs depend on SW1 position settings) |
| SW1-B | Off | ONA pin is connected to GND                        | Disables VOUTA, VOUTA = 0V                               |
|       | On  | ONA pin is connected to VDD                        | Enables VOUTA, VOUTA = 5V                                |
| SW1-C | Off | ONB pin is connected to GND                        | Disables VOUTB, VOUTB = 0V                               |
|       | On  | ONB pin is connected to VDD                        | Enables VOUTB, VOUTB = 1.8V                              |
| SW1-D | Off | ONC pin is connected to GND                        | Disables VOUTC, VOUTC = 0V                               |
|       | On  | ONC pin is connected to VDD                        | Enables VOUTC, VOUTC = 1.05V                             |
| SW1-E | Off | OND pin is connected to GND                        | Disables VOUTD, VOUTD = 0V                               |
|       | On  | OND pin is connected to VDD                        | Enables VOUTD, VOUTD = 0.9V                              |

**Note:** As configured, the MAX17019N EV kit is shipped with all SW1 settings in the off position.

**Table 2. Switching-Frequency Selection**

| FREQ PIN                                   | SWITCHING FREQUENCY |        |        |
|--|---------------------|--------|--------|
|  | VOUTA               | VOUTB  | VOUTC  |
| Connected to VDD through open resistor R24 | 250kHz              | 500kHz | 250kHz |
| Connected to REF through open resistor R20 | 375kHz              | 750kHz | 375kHz |
| Connected to GND through 0Ω resistor R21*  | 500kHz              | 1MHz   | 500kHz |

\*Default position.

# MAX17019N Evaluation Kit

Evaluates: MAX17019

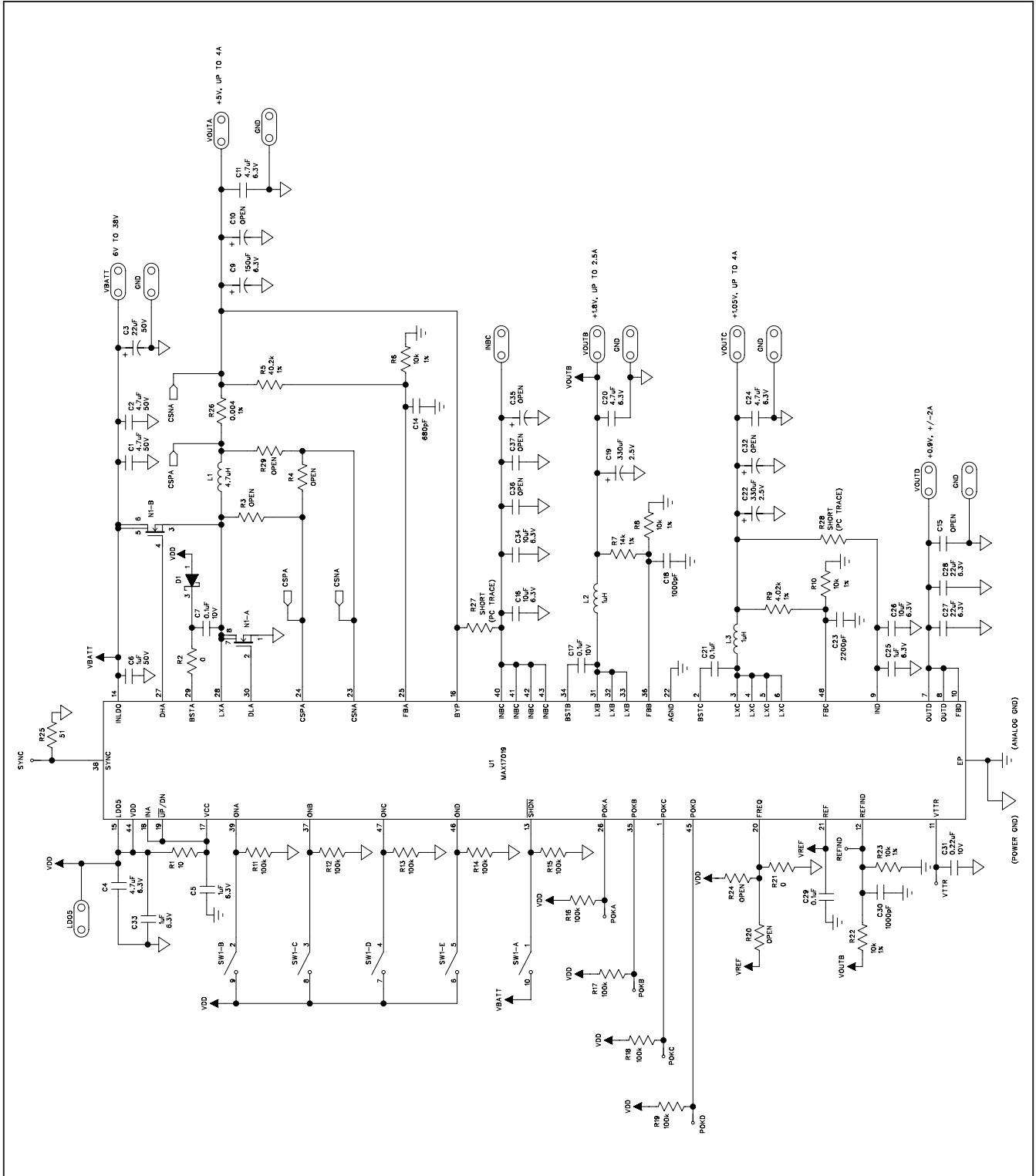

Figure 1. MAX17019N EV Kit Schematic

# MAX17019N Evaluation Kit

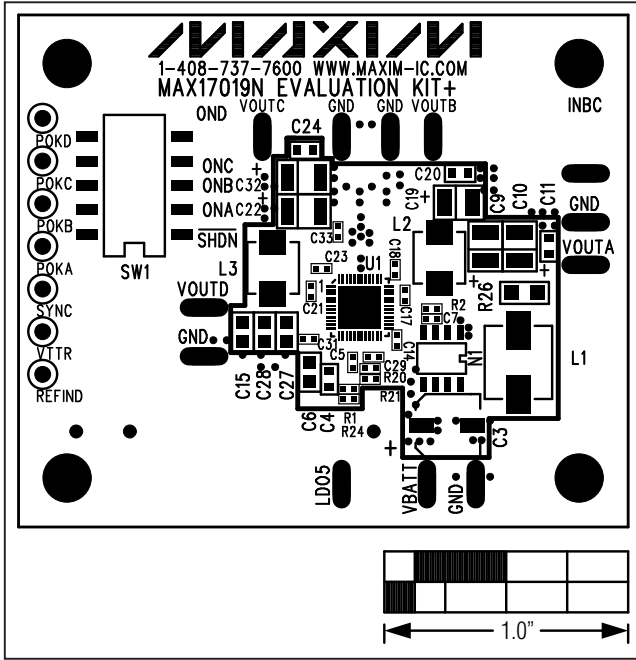

Figure 2. MAX17019N EV Kit Component Placement Guide—Component Side

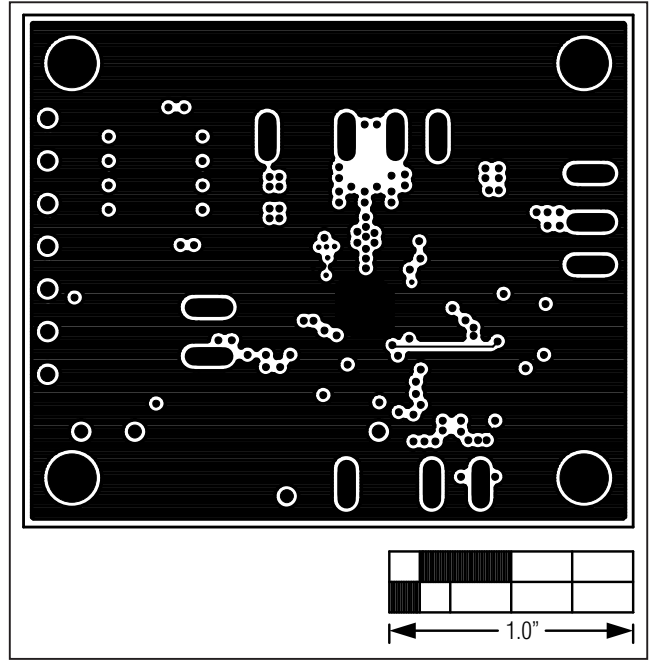

Figure 4. MAX17019N EV Kit PCB Layout—Layer 2

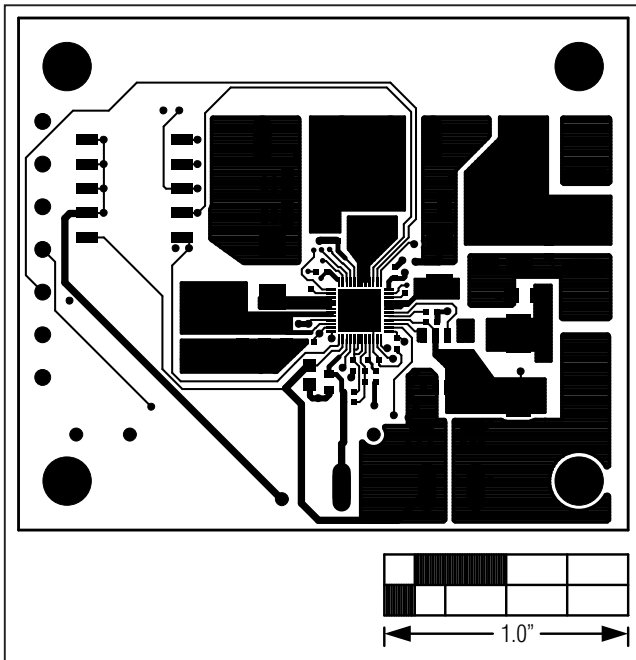

Figure 3. MAX17019N EV Kit PCB Layout—Component Side

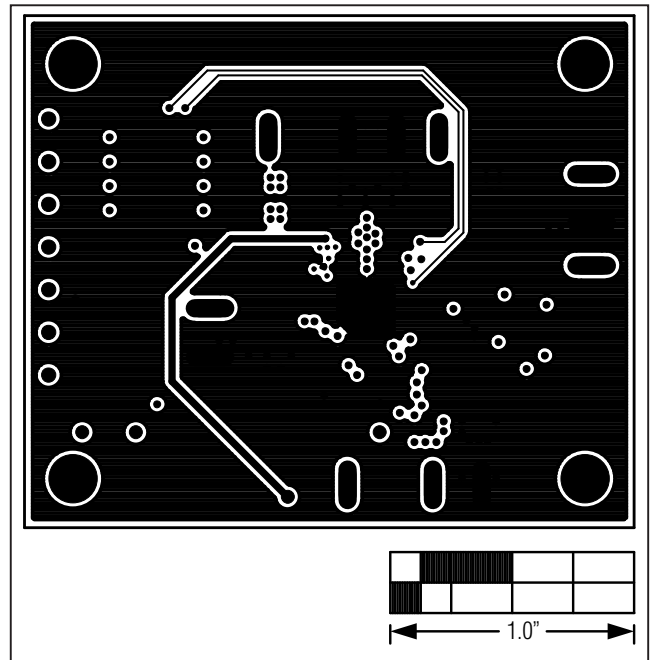

Figure 5. MAX17019N EV Kit PCB Layout—Layer 3

# MAX17019N Evaluation Kit

Evaluates: MAX17019

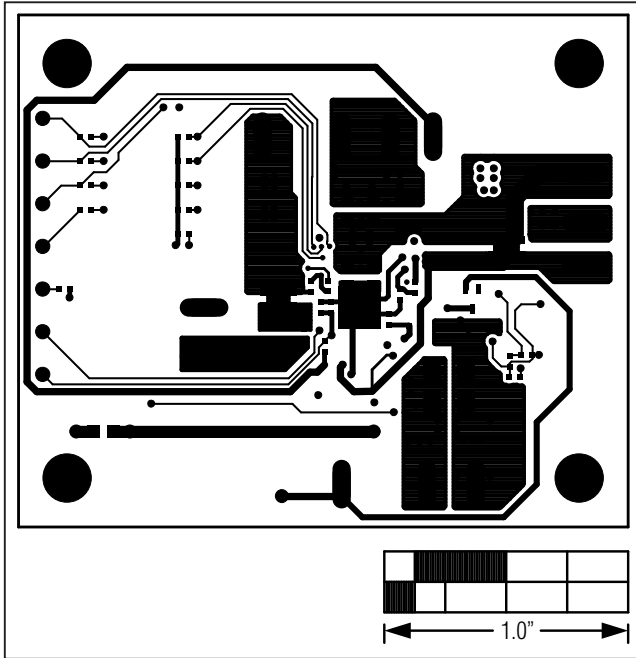

Figure 6. MAX17019N EV Kit PCB Layout—Solder Side

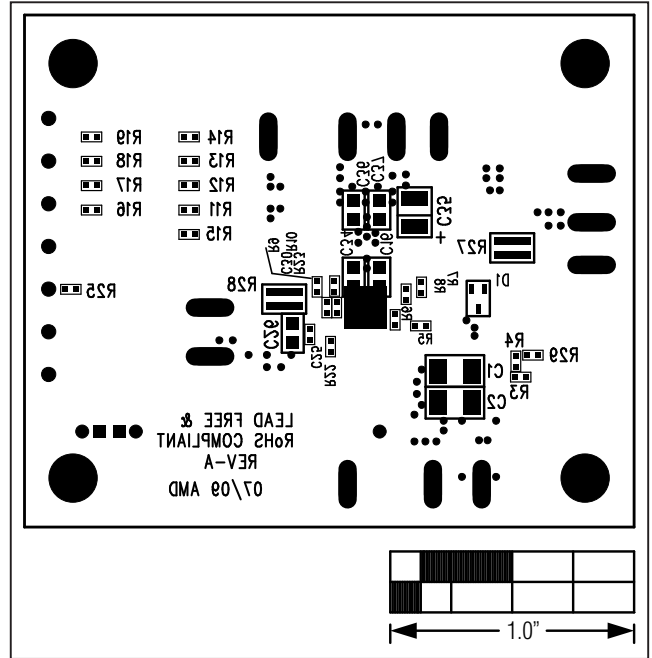

Figure 7. MAX17019N EV Kit Component Placement Guide—Solder Side

# MAX17019N Evaluation Kit

## Revision History

| REVISION NUMBER | REVISION DATE | DESCRIPTION     | PAGES CHANGED |
|-----------------|---------------|-----------------|---------------|
| 0               | 6/11          | Initial release | —             |

Maxim cannot assume responsibility for use of any circuitry other than circuitry entirely embodied in a Maxim product. No circuit patent licenses are implied. Maxim reserves the right to change the circuitry and specifications without notice at any time.

8 \_\_\_\_\_ **Maxim Integrated Products, 120 San Gabriel Drive, Sunnyvale, CA 94086 408-737-7600**

© 2011 Maxim Integrated Products

Maxim is a registered trademark of Maxim Integrated Products, Inc.