

THE LENGTH AFTER INSERT CARD

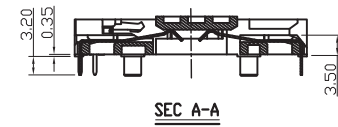

SEC A-A

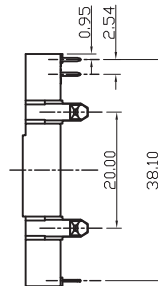
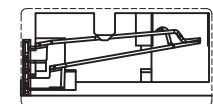

Close Type

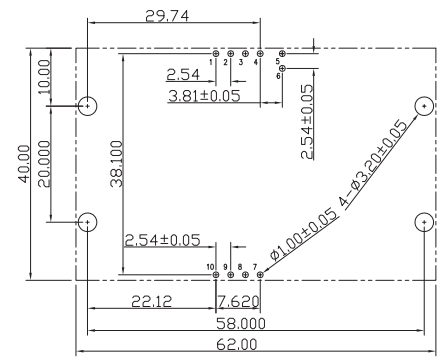
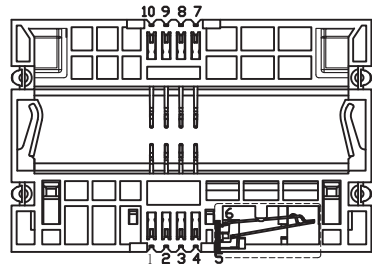
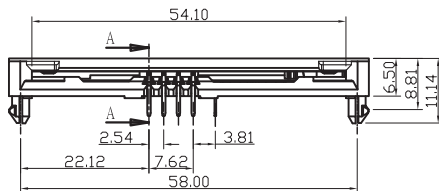

RECOMMENDED P.C.B. LAYOUT
P.C.B THICKNESS=1.60mm

TECHNICAL CHARACTERISTICS

MATERIAL
INSULATOR: PBT
FLAMABILITY RATING: UL94-V0
COLOR: BLACK
CONTACT MATERIAL: COPPER ALLOY
CONTACT TYPE: STAMPED
CONTACT PLATING: SELECTIVE GOLD
LATCH: STAINLESS STEEL
QUALITY CLASS: 100000 MATING CYCLES

ENVIRONMENTAL
OPERATING TEMPERATURE: -40 UP TO 85°C
COMPLIANCE: LEAD FREE AND ROHS

ELECTRICAL
CURRENT RATING: 1A
WORKING VOLTAGE: 50VDC
INSULATOR RESISTANCE: >1000 MOHM
DIELECTRIC WITHSTANDING VOLTAGE:
750VAC FOR DATA CONTACTS
250VAC FOR SWITCH CONTACTS
CONTACT RESISTANCE: 100 mOHM MAX

SOLDERING
WAVE PROCESS ONLY

PACKAGING
TRAY

RoHS Compliant			
G			
F			
E			
D			
C			
B	21-JAN-13	REF ON P2	QL
A	08-JUL-12	PDF	GG
REV	DATE	FILE	BY

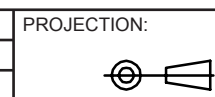

GENERAL TOLERANCE
.X = +/- 0.2
.XX = +/- 0.15



APPROVAL: RJ

UNIT: MM
SCALE:
SHEET: 1/2
DRAW: VICKY

DESCRIPTION: WR-CRD Smart Card_Standard Header
WERI PART NO: 693 030 010 810

SIZE
A4

1

2

3

4

5

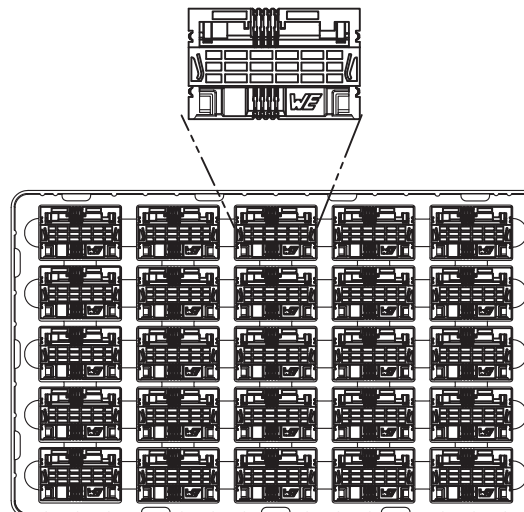
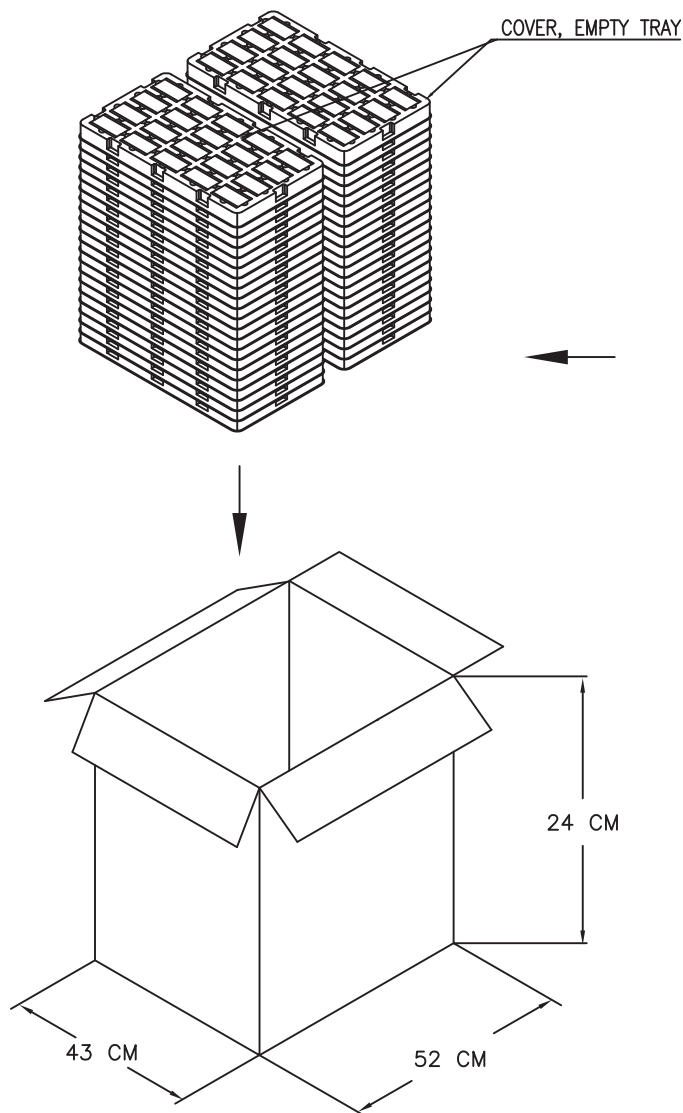

TY PART NO.	52008-XXXW1X0G
DESCRIPTION	SMART CARD CONNECTOR
PCS/TRAY	25
TRAY/BOX	38+2(空盤)
TOTAL (PCS)	950
CTN SIZE	52X43X24 CM
TRAY MATERIAL	PS, WHITE
NW	8.5 KG
GW	11.8 KG

RoHS Compliant

PROJECTION:

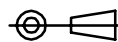

GENERAL TOLERANCE

.X = ± 0.2 .XX = ± 0.15 

WÜRTH ELEKTRONIK

APPROVAL: RJ

UNIT: MM

SCALE:

SHEET: 2/2

DRAW: VICKY

DESCRIPTION: SIM Card Connector - Header - 6 pins

WERI PART NO: 693 030 010 810

SIZE

A4

REV

DATE

FILE

BY