

300 Watts

SDM Series

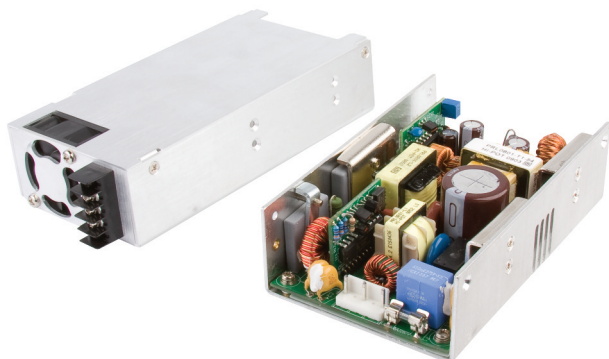

- Medical Approvals
- 3.2" x 5" Footprint
- Fits 1U Applications
- High Efficiency
- Up to 600 W Peak Power
- Single & Dual Outputs
- 3 Year Warranty

Specification

Input

Input Voltage	• 90-264 VAC
Input Frequency	• 47-63 Hz
Input Current	• 5.0 A at 90 VAC, 2 A at 230 VAC
Inrush Current	• Max 70 A at 230 VAC, 35 A at 115 VAC, cold start 25 °C
Power Factor	• >0.9
Earth Leakage Current	• <250 µA at 264 VAC, 60 Hz
Input Protection	• T5 A / 350 V internal in line fuse

Output

Output Voltage	• See table
Output Voltage Trim	• ±5% on V1 (V2 of dual output models will track by same % of adjustment)
Initial Set Accuracy	• ±1%
Minimum Load	• 10% on both outputs of dual output models
Start Up Delay	• 1.1 s max at 120 VAC
Start Up Rise Time	• 100 ms typical
Hold Up Time	• 16 ms min at 80% of full load, 120 VAC
Line Regulation	• ±0.5%
Load Regulation	• ±1% 1-100% load for single outputs ±3% V1, ±7% V2 for dual output models
Over/Undershoot	• 5% max
Transient Response	• 5% max deviation, recovery to within 1% in 2.5 ms for a 50% load change
Ripple & Noise	• 1% pk-pk (see note 1)
Overvoltage Protection	• 110-130% Vnom on output V1, recycle input to reset
Overtemperature Protection	• Measured internally with auto recovery
Overload Protection	• 110-140%
Short Circuit Protection	• Trip & restart (hiccup mode), auto recovery
Remote On/Off	• Requires a low signal to inhibit output
Fan Supply	• 12 VDC, 300 mA, not available on '-F', '-E' or '-K' versions with built-in fan

General

Efficiency	• Single output models: typically 86% Dual output models: typically 82%
Isolation	• 4000 VAC Input to Output 1500 VAC Input to Ground 250 VDC Output to Ground
Switching Frequency	• 40-70 kHz PFC variable, 55 kHz - 75 kHz PWM fixed
Power Density	• 12.5 W/in ³
Signals	• Power Good goes Hi 100-500 ms after output is in regulation and goes Low at least 0.6 ms before loss of regulation
MTBF	• 116 kHrs to MIL-HDBK-217F at 25 °C, GB

Environmental

Operating Temperature	• -10 °C to +70 °C, derate at 2.5%/ °C from +50 °C to +70 °C
Storage Temperature	• -20 °C to +85 °C
Operating Humidity	• 5-90%, non-condensing
Storage Humidity	• 5-95%, non-condensing
Cooling	• '-F', '-E' & '-K' versions have built-in fan, others require 15 CFM to meet forced air ratings
Operating Altitude	• 3000 m
Shock	• 30 g, 11ms half sine, 6 axes
Vibration	• 2 g, 10-200 Hz, 3 axes

EMC & Safety

Emissions	• EN55011 Level B conducted & radiated
Harmonic Currents	• EN61000-3-2 class A EN61000-3-2 class C for loads ≥40%
Voltage Flicker	• EN61000-3-3
ESD Immunity	• EN61000-4-2, level 3 Perf Criteria A
Radiated Immunity	• EN61000-4-3, 3 V/m Perf Criteria A
EFT/Burst	• EN61000-4-4, level 2 Perf Criteria A
Surge	• EN61000-4-5, installation class 3, Perf Criteria A
Conducted Immunity	• EN61000-4-6, 3V Perf Criteria A
Dips & Interruptions	• EN61000-4-11, 30% 500 ms, 60% 100 ms, 100% 10 ms, 100% 5000 ms, Perf Criteria A, A, A, B at 230 VAC and 100 VAC with reduced load
Safety Approvals	• ANSI/AMMI ES60601-1, CSA C22.2 No. 60601-1, EN60601-1, All 3rd Edition

Models and Ratings

Output Voltage	Output Power	Output Current		Model Number ^(3,4,5,6)
		Nominal	Peak ⁽²⁾	
12 V	300 W	25.00 A	50.00 A	SDM300PS12-F
15 V	300 W	20.00 A	40.00 A	SDM300PS15-F ⁽⁶⁾
24 V	300 W	12.50 A	25.00 A	SDM300PS24-F
36 V	300 W	8.33 A	16.67 A	SDM300PS36-F ⁽⁶⁾
48 V	300 W	6.25 A	12.50 A	SDM300PS48-F
V1: +5.00 V V2: +12.0 V	240 W	24.00 A 13.3 A	28.80 A 16.00 A	SDM300PD0512-F
V1: +12.0 V V2: +24.0 V	240 W	13.33 A 6.67 A	16.00 A 8.00 A	SDM300PD1224-F

Notes

- Ripple & noise is measured using a 0.1 μ F ceramic capacitor in parallel with 22 μ F electrolytic and 20 MHz bandwidth
- Peak load can be taken for 500 μ s. Average power not to exceed max power.
- Replace suffix '-F' with suffix '-E' for end fan cover with screw terminal option e.g. SDM300PS24-E or suffix '-K-E' for end fan cover with IEC inlet option e.g. SDM300PS24K-E
- Add suffix 'D' for optional output terminal block on single output models except the 12 V output models which are only available with output terminal blocks eg. SDM300PS24D-F.⁽⁶⁾
- Add suffix 'G' for optional input terminal blocks eg. SDM300PS24DG-F, except for enclosed with end fan (option '-E') which has input terminal blocks as standard.⁽⁶⁾
- Available for OEM quantities, contact Sales.

Mechanical Details

Enclosed with top fan

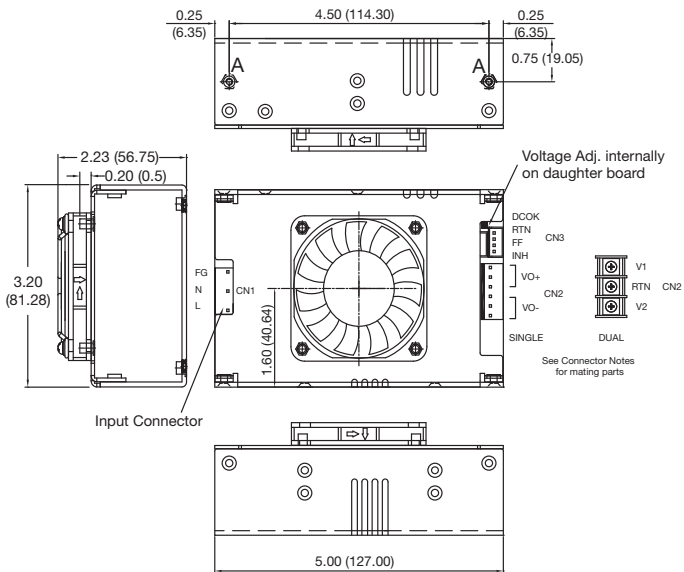

Enclosed with end fan (Option '-E')

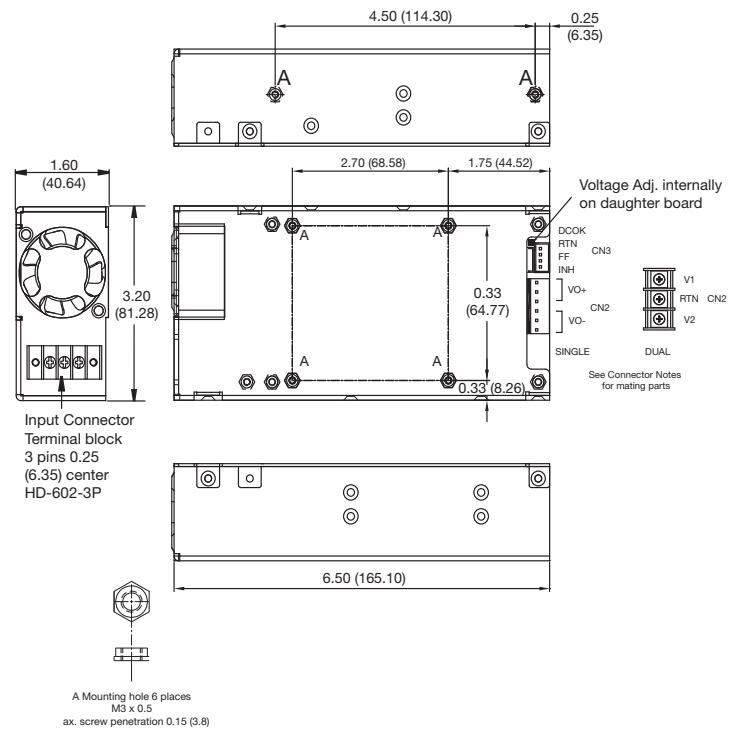

Notes

- All dimensions are in inches (mm)
- Tolerance: ± 0.012 (± 0.3)
- Weight: Enclosed with top fan (option '-F'): 1.32 lbs (600 g)
Enclosed with end fan (option '-E' & '-K'): 1.43 lbs (650 g)
- Mounting holes and mating half connectors common to all models.

Models and Ratings

Output Voltage	Output Power		Output Current			Model Number ^(3,4,5)
	Forced Cooled	Convection Cooled	Forced Cooled	Convection Cooled	Peak ⁽²⁾	
12 V	300 W	150 W	25.00 A	12.50 A	50.00 A	SDM300PS12
15 V	300 W	150 W	20.00 A	10.00 A	40.00 A	SDM300PS15 ⁽⁶⁾
24 V	300 W	150 W	12.50 A	6.25 A	25.00 A	SDM300PS24
36 V	300 W	150 W	8.33 A	4.17 A	16.67 A	SDM300PS36 ⁽⁶⁾
48 V	300 W	150 W	6.25 A	3.12 A	12.50 A	SDM300PS48
V1: +5.00 V V2: +12.0 V	240 W	120 W	24.00 A 13.3 A	12.00 A 6.67 A	28.80 A 16.00 A	SDM300PD0512
V1: +12.0 V V2: +24.0 V	240 W	120 W	13.33 A 6.67 A	6.67 A 3.33 A	16.00 A 8.00 A	SDM300PD1224

Notes

- Ripple & noise is measured using a 0.1 μ F ceramic capacitor in parallel with 22 μ F electrolytic and 20 MHz bandwidth
- Peak load can be taken for 500 μ s. Average power not to exceed max power.
- Add suffix 'D' for optional output terminal block on single output models except the 12 V output models which are only available with
- Add suffix 'G' for optional input terminal blocks eg. SDM300PS24DG-F, except for enclosed with end fan (option '-E') which has input terminal blocks as standard.⁽⁶⁾
- Add suffix 'H' for optional molex output terminal on dual output models used in convection applications.⁽⁶⁾
- Available for OEM quantities, contact Sales.

Mechanical Details

U-Channel

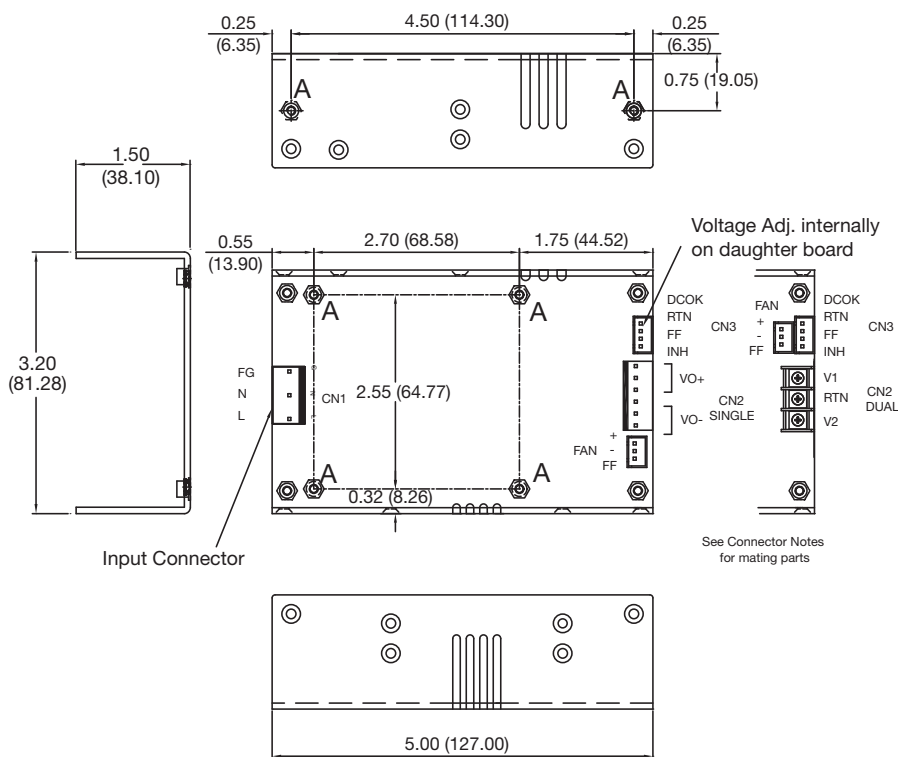

Notes

- All dimensions are in inches (mm)
- Tolerance: ± 0.012 (± 0.3)
- Weight: U-Channel: 1.1 lbs (500 g)
- Mounting holes and mating half connectors common to all models.

Thermal Considerations - U Channel

Single Output Models

Dual Output Models

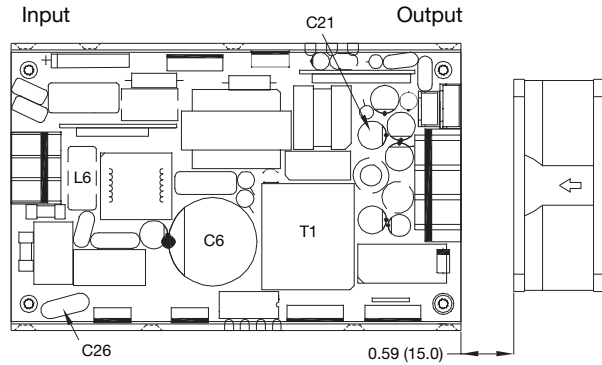
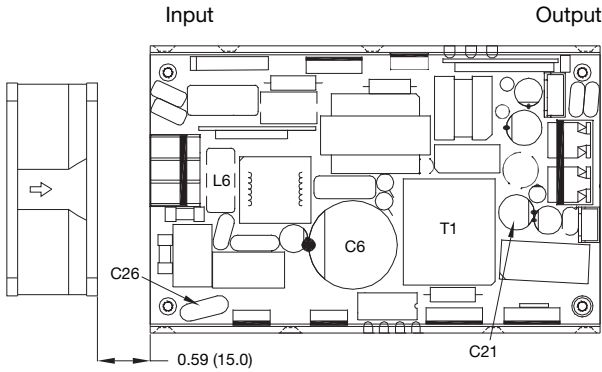

In order to ensure safe operation of the PSU in the end-use equipment, the temperature of the components listed in the table (right) must not be exceeded. See drawing above for component locations. The temperature should be monitored using K type thermocouples placed on the hottest part of the component (out of any direct airflow).

Temperature Measurement	
Component	Max Continuous Temp °C
C26	85
C6	105
C21	105
L6	130
T1 Coil	140

Remote On/Off (INH)

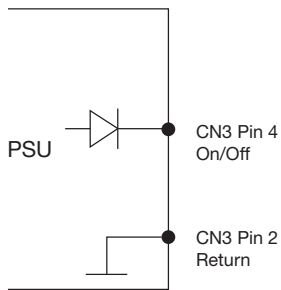

- Note:**
- Applying <math><0.3\text{ V}</math> or short between pins 4 and 2 turns the output OFF.
 - Applying >math>>4.5\text{ V}</math> or open circuit between pins 4 and 2 turns output ON.

Power Good (PG)

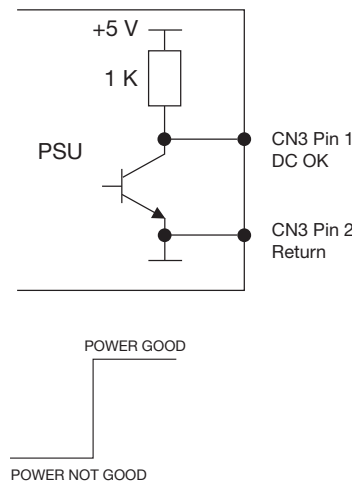

- Note:**
- Sink current = 6 mA, Source current = 1 mA
 - Power is good 100-500 ms after output is in regulation.
 - Power not good at least 1 ms before loss of regulation.

Fan Fail (FF)

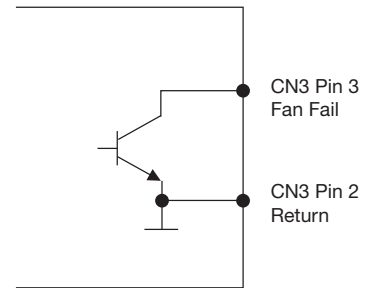

- Note:**
- Transistor On : Fan OK
 - Transistor Off : Fan Fail

- Note:**
- Open collector signal: 28 V maximum voltage and 5 mA (maximum sink current)

Connectors

INPUT CONNECTORS

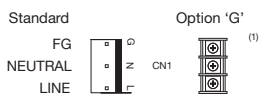

Mating JST part no. VHR-5N or equivalent (5 pin, 3 used)
Crimp contacts for JST VHR Series:
SVH-21T-P1.1 - 22-18awg
SVH-41T-P1.1 - 20-16awg

Terminal block 3 pins 0.25 (6.35) center HD-601-3P

OUTPUT CONNECTORS

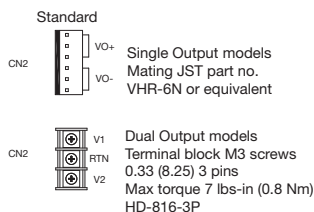

Single Output models
Mating JST part no. VHR-6N or equivalent

Dual Output models
Terminal block M3 screws 0.33 (8.25) 3 pins
Max torque 7 lbs-in (0.8 Nm)
HD-816-3P

SIGNALS & FAN CONNECTORS

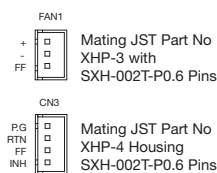

Mating JST Part No XHP-3 with SXH-002T-P0.6 Pins

Mating JST Part No XHP-4 Housing SXH-002T-P0.6 Pins

OPTIONAL OUTPUT CONNECTORS⁽¹⁾

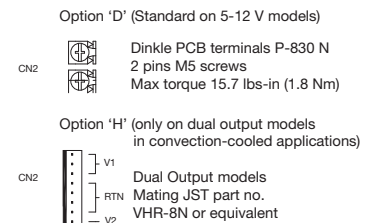

Option 'D' (Standard on 5-12 V models)
Dinkle PCB terminals P-830 N
2 pins M5 screws
Max torque 15.7 lbs-in (1.8 Nm)

Option 'H' (only on dual output models in convection-cooled applications)
Dual Output models
Mating JST part no. VHR-8N or equivalent

1. Available for OEM quantities, contact Sales.