



MA520.A.BC.008
on ground-plane

Hercules

MA520.A.BC.008

Specification

Part No.	MA520.A.BC.008
Product Name	Hercules 2in1 Cellular and Wi-Fi Heavy Duty Screw Mount Antenna - Cellular 2G/3G HSPA/GSM/GPRS/CDMA/EVDO/UMTS/WCDMA 850/900/1800/1900/2100 MHz - WIFI Dual Band Antenna 2.4 GHz / 5.8 GHz
Feature	Low Profile and Vandal Proof 2M RG-316 Cellular - SMA(M) 2.4/5.8 GHz - RP-SMA(M) IP67 and IP69K Waterproof Rating IEEE.802.11/IEEE.802.15 RoHS Compliant



1. Introduction

The MA520 Hercules 2in1 Penta Band Cellular-2.4/5.8GHz Antenna is the smallest package high performance screw-mount (permanent mount) antenna available, for external use on vehicles and outdoor assets worldwide.

Everything is in the one housing reducing the need for multiples antenna installations. This is the ideal antenna for 3G gateway routers that provide Wi-Fi hotspots.

It has been designed for heavy duty work with extra thick threads; with durable UV-resistant ABS housing is resistant to vandalism and direct attack.

At only 29mm high and 49mm in diameter this antenna enables covert operation and its quality is proven by growing adoption by many of the world's largest wireless brands worldwide.

The standard cable length is 1 meter, the antenna can work to cable lengths of 2 meters. The Hercules MA520 exceptional design means it can work equally well mounted on or without ground-plane.

The antenna housing is completely waterproof to IP67, and also to IP69K, which means it is waterproof against high pressure water jets used in industrial environments for cleaning.

2. Specification

Electrical

Standard	AMPS	GSM	DCS	PCS	3G	ISM	ISM
Band (MHz)	850	900	1800	1900	2100	2400	5000
Frequency (MHz)	824-894	880-960	1710-1880	1850-1990	1920-2170	2400-2483	5000-5825
Polarization	Linear						
Impedance (Ohms)	50Ω						
Gain (dBi)							
Cable length	0.3	1.7	0.9	1.3	3.5	1.5	
(Meter)	1.0	1.2	2.1	0.7	1.2	-0.3	3.8
	2.0	1.0	1.5	0.4	-0.5	-1.1	2.1
	3.0	0.9	1.0	-1.0	-1.5	-2.2	
	5.0	-1.0	-0.7	-4.5	-4.0	-4.3	-1.0
							-4.2
Efficiency (%)							
Cable length	0.3	50.5	40	38.	46.5	32.3	
(Meter)	1.0	29	41	41	43.4	29.9	40.0
	2.0	23.5	26.8	29	20.2	19.6	20.0
	3.0	25	27	22.0	17.8	15.0	
	5.0	18	15.5	15	15.0	12.0	8.5
							8.0
Return Loss (dB)							
Cable length	0.3	-6.0	-5.5	-6.1	-6.2	-5.8	
(Meter)	1.0	-7.8	-8	-11.4	-15.3	-13.7	-20.0
	2.0	-8.1	-8.5	-16.5	-20.3	-19.5	-18.0
	3.0	-11.0	-13	-17.5	-18.3	-18.1	
	5.0	-11.8	-14	-17.6	-17.8	-17.8	-25.0
							-25.0
Radiation Properties	Omni-Directional						
Max Input Power	10 Watts max.						

2. Specification

Mechanical

Dimensions (mm)	Height=29mm x Diameter=49mm
Cable	2 Meters RG316 (Fully Customizable)
Connector	<i>Cellular:</i> SMA(M) - <i>Wi-Fi:</i> RP-SMA(M) (Fully Customizable)
Tread Diameter	18 mm
Casing	UV Resistant ABS
Weather proof gasket	CR4305 foam with 3M9448B double-side adhesive
Sealant	Rubber Stopper
Base and Thread	Nickel Plated Zinc Alloy

Environmental

Protection	IP67
Corrosion	5% NACL for 96hrs
Temperature Range	-40°C to +85°C
Thermal Shock	100 cycles -40°C to +85°C
Humidity	Non-condensing 65°C 95% RH
Shock (Drop Test)	1m drop on concrete 6 axes
Cable Pull	8 Kgf

***Note:** The MA520 antenna performance was measured on a 60X60cm metal plate

3. Test Set Up

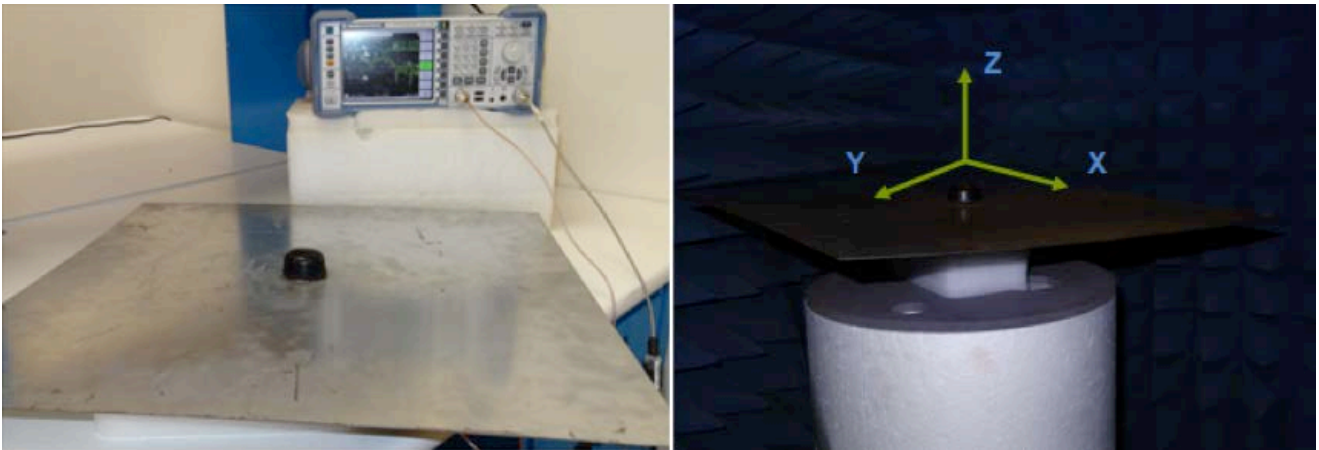

Figure 1. Impedance measurement (left hand) and efficiency and radiation pattern measurements (right hand).

4. Antenna Parameters

4.1 Return Loss

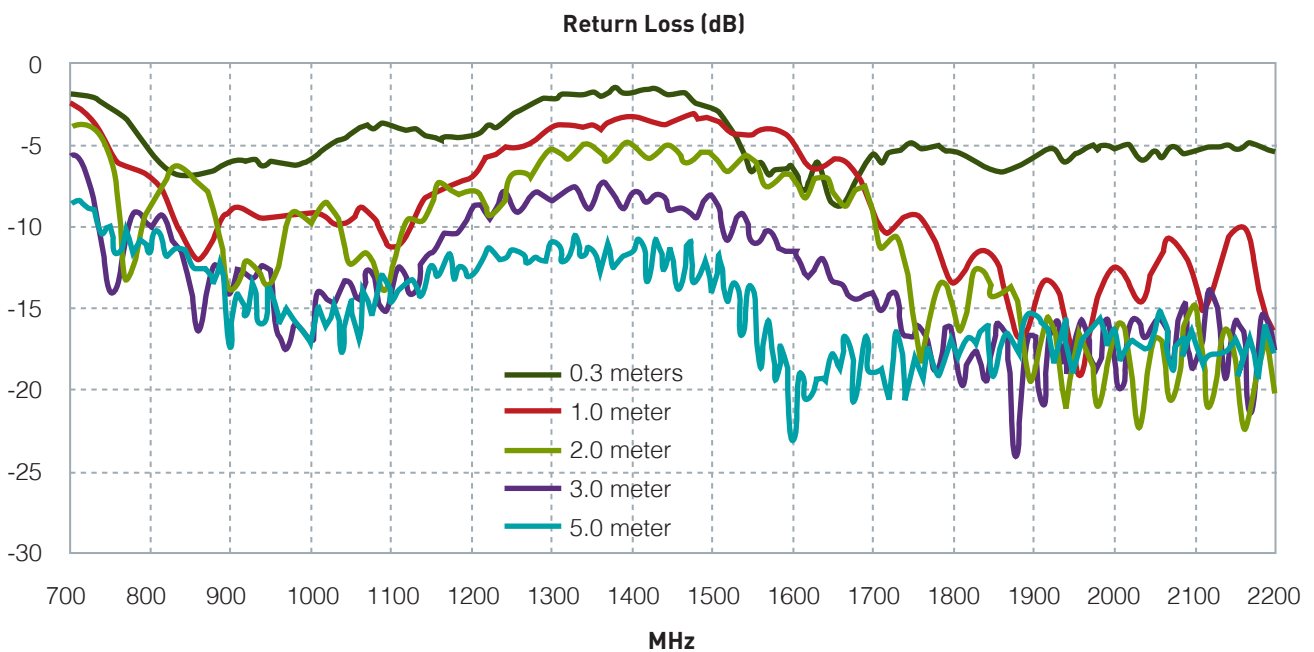

Figure 2. Return loss of MA520 Cellular Antenna in free space.

4. Antenna Parameters

4.1 Return Loss

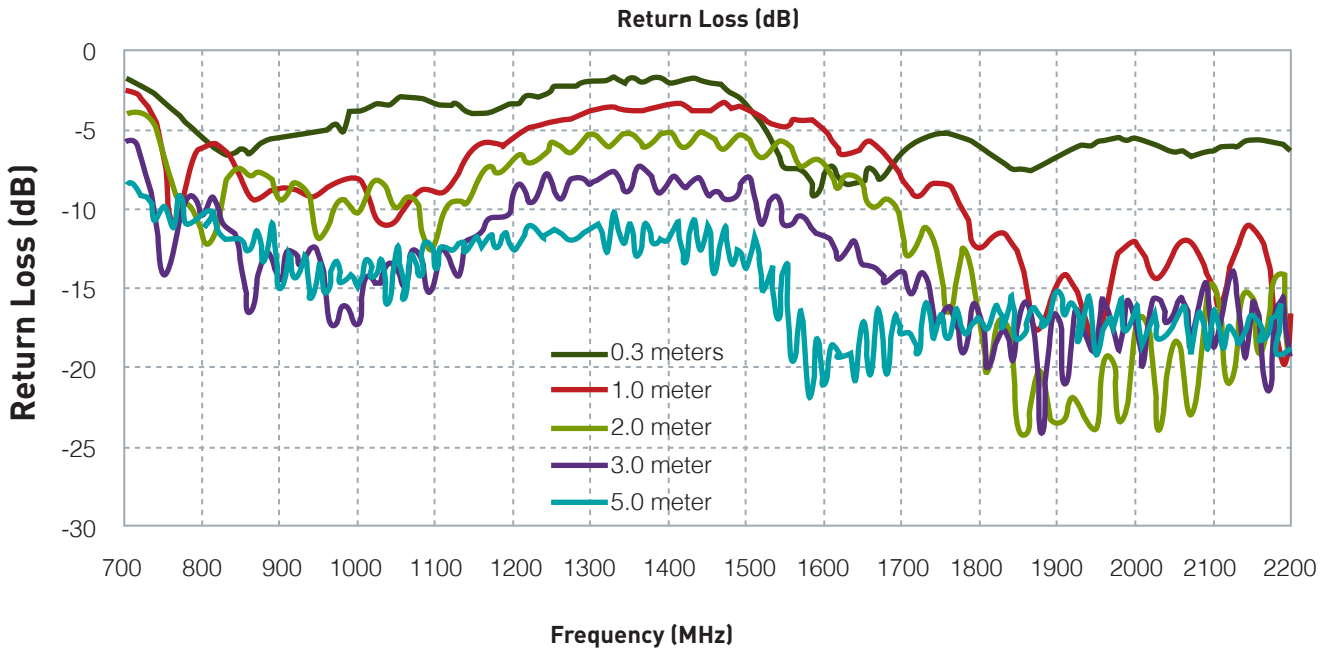

Figure 3. Return loss of MA520 Cellular Antenna on 30*30 cm metal plate.

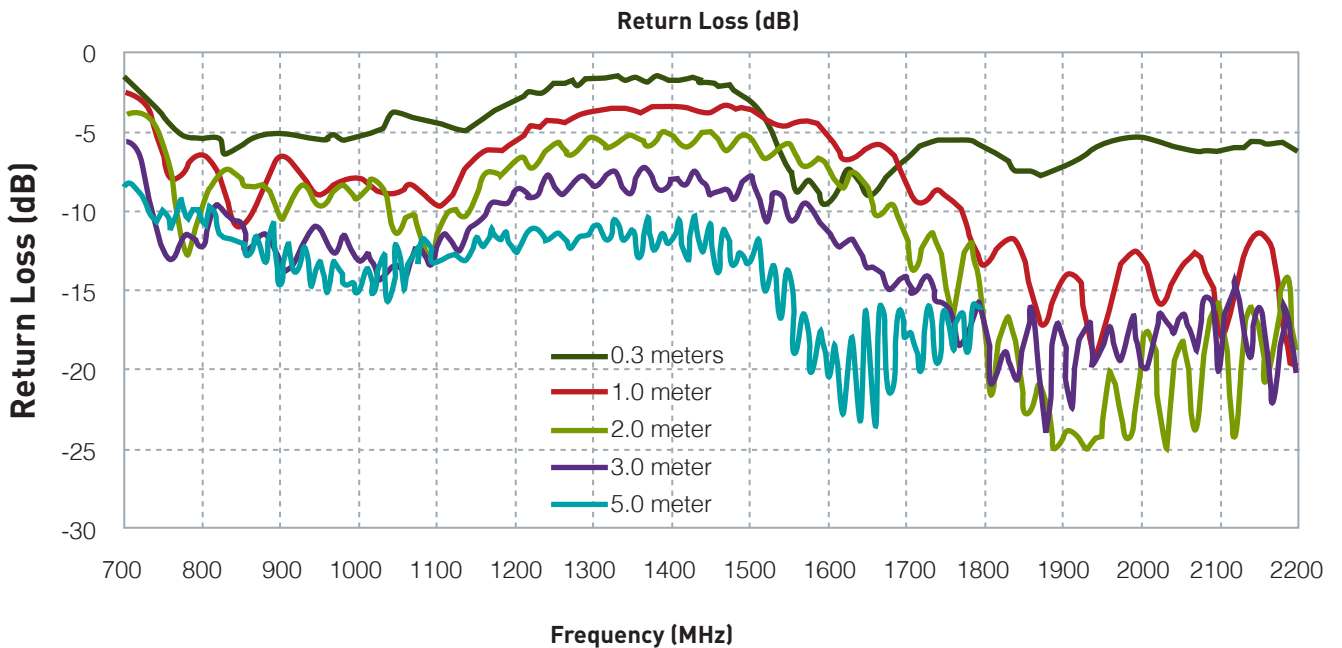

Figure 4. Return loss of MA520 Cellular Antenna on 60 *60 cm metal plate.

4. Antenna Parameters

4.1 Return Loss

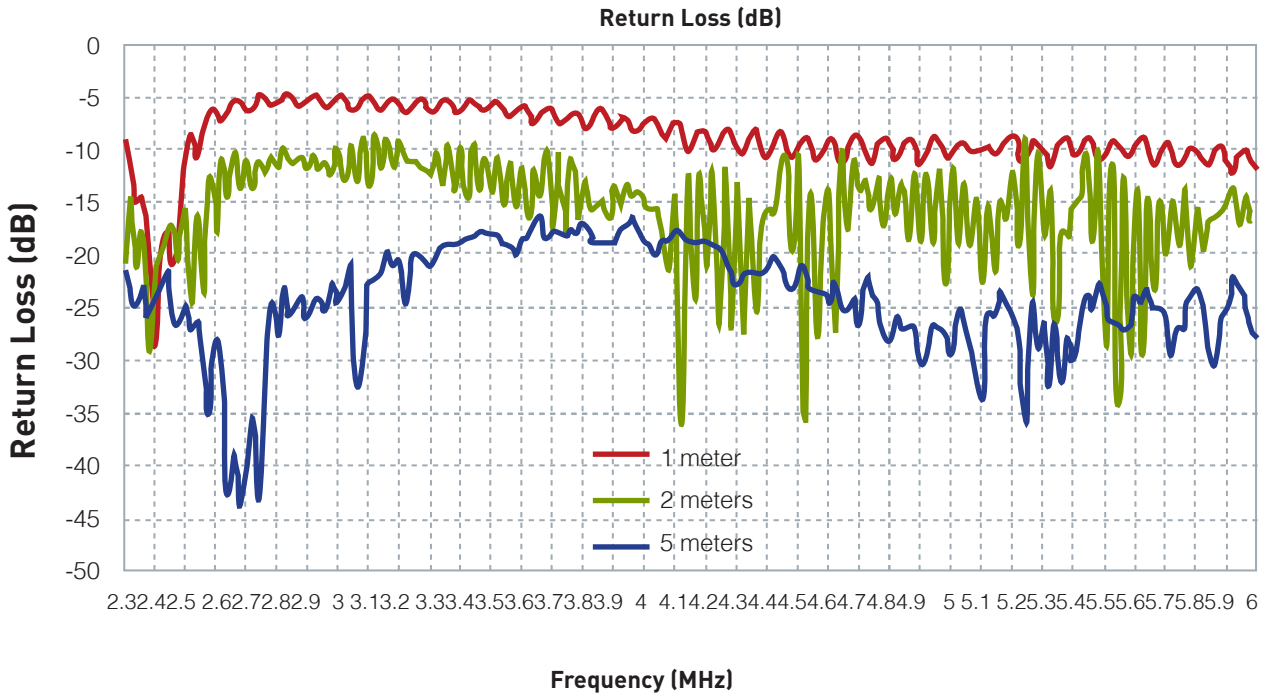

Figure 5. Return loss of MA520 2.4/5 GHz Antenna on 60*60cm metal plate.

4.2 Efficiency

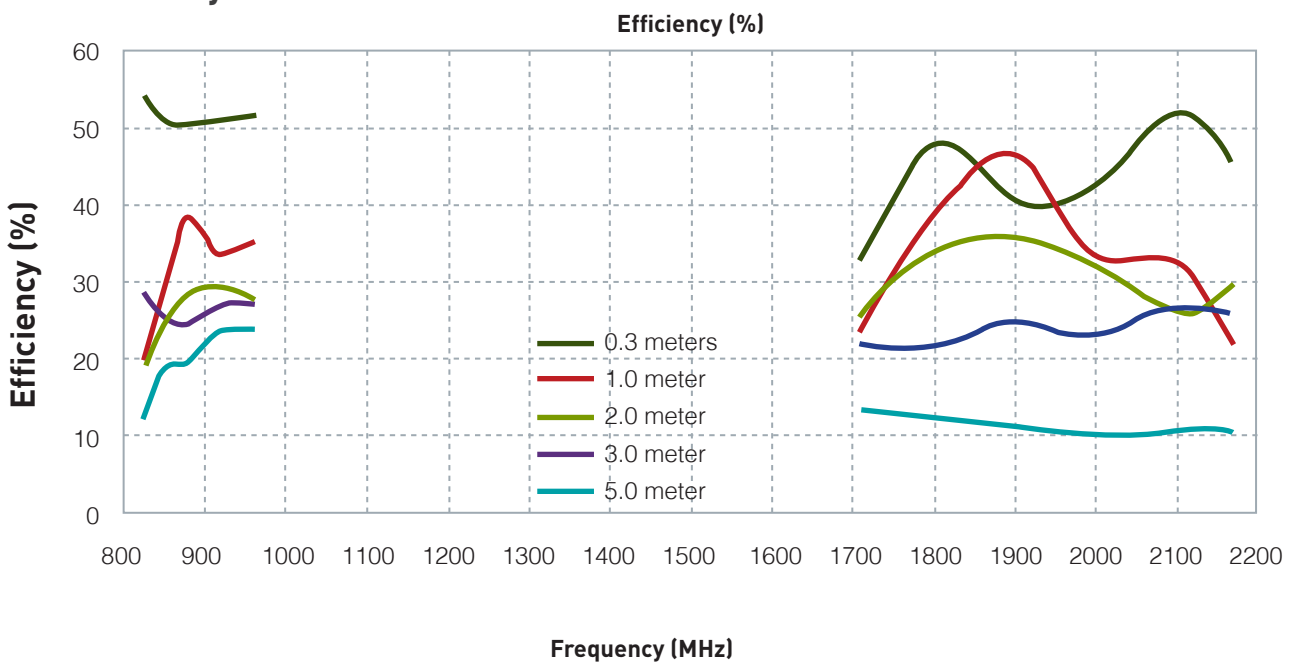

Figure 6. Efficiency of MA520 Cellular Antenna in free space.

4. Antenna Parameters

4.2 Efficiency

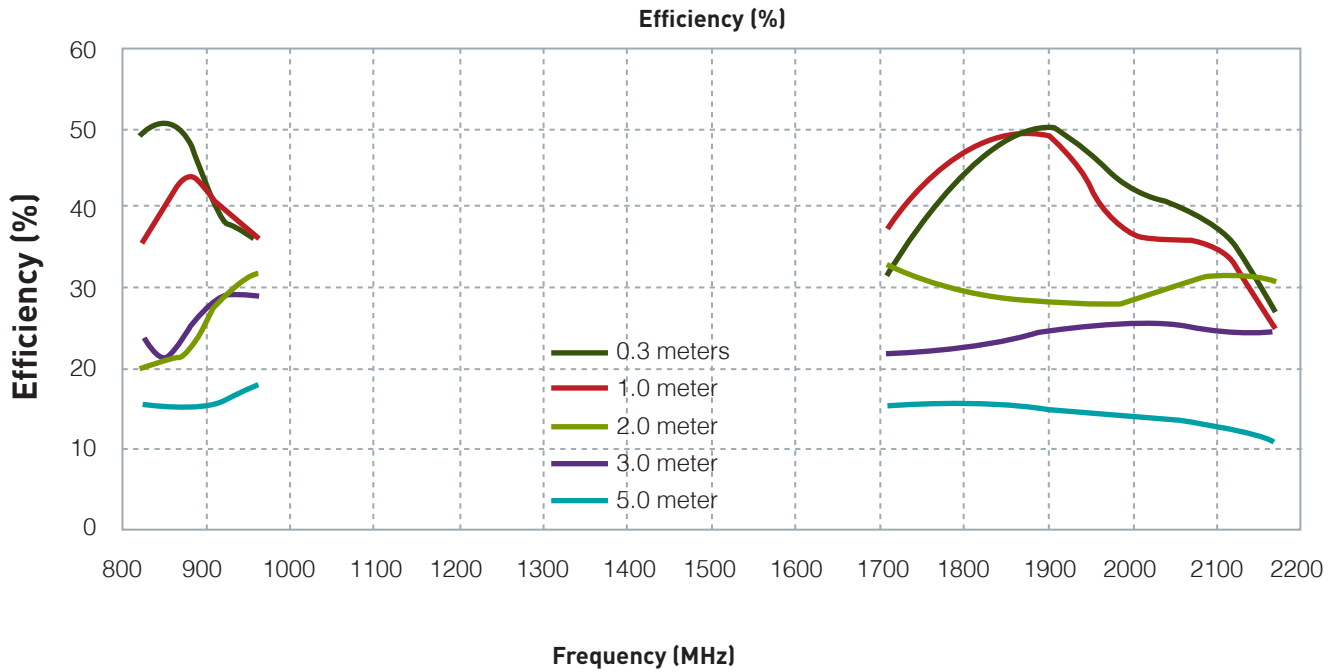

Figure 7. Efficiency of MA520 Cellular Antenna on 30*30cm metal plate

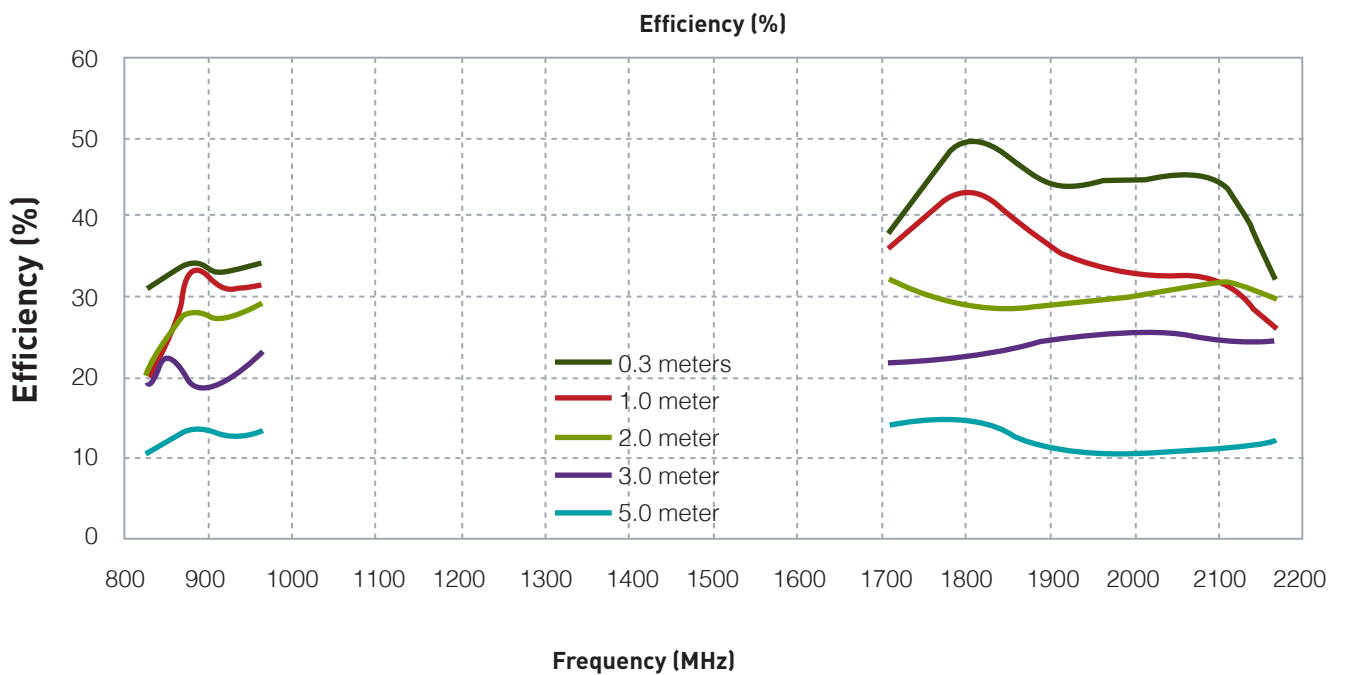

Figure 8. Efficiency of MA520 Cellular Antenna on 60*60 cm metal plate.

4. Antenna Parameters

4.2 Efficiency

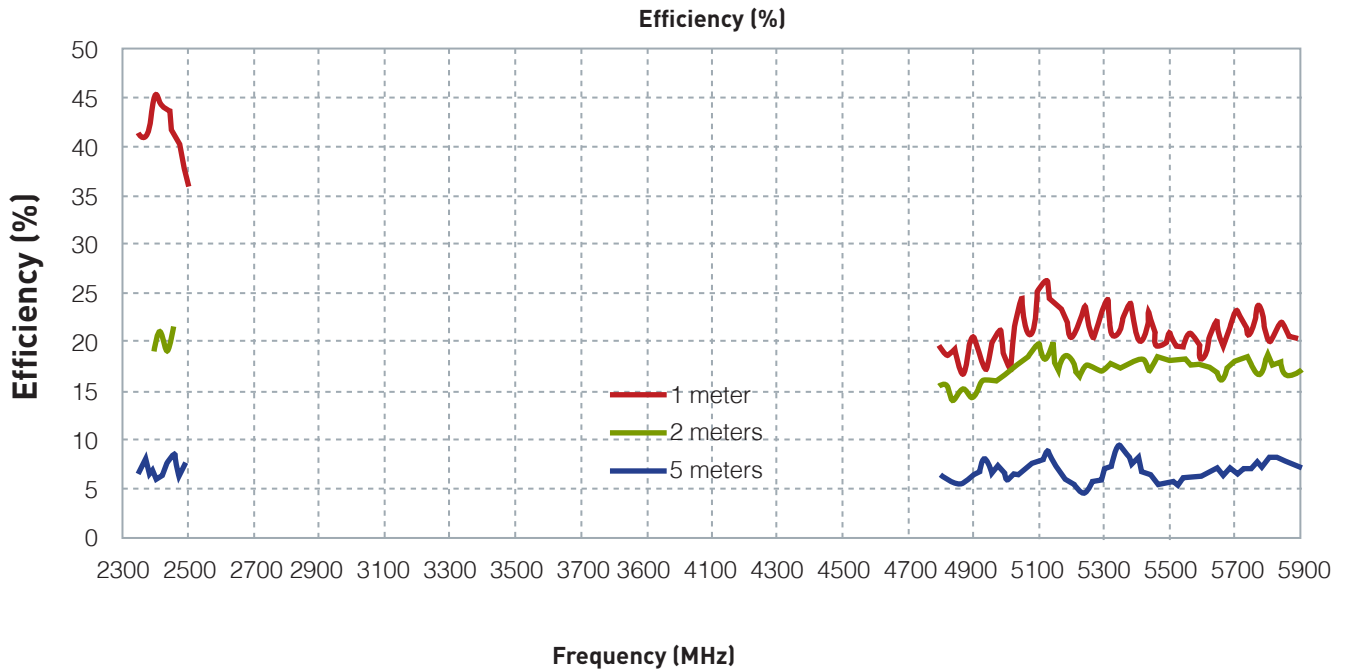

Figure 9. Efficiency of MA520 2.4/5 GHz Antenna on 60*60 cm metal plate.

4.2 Gain

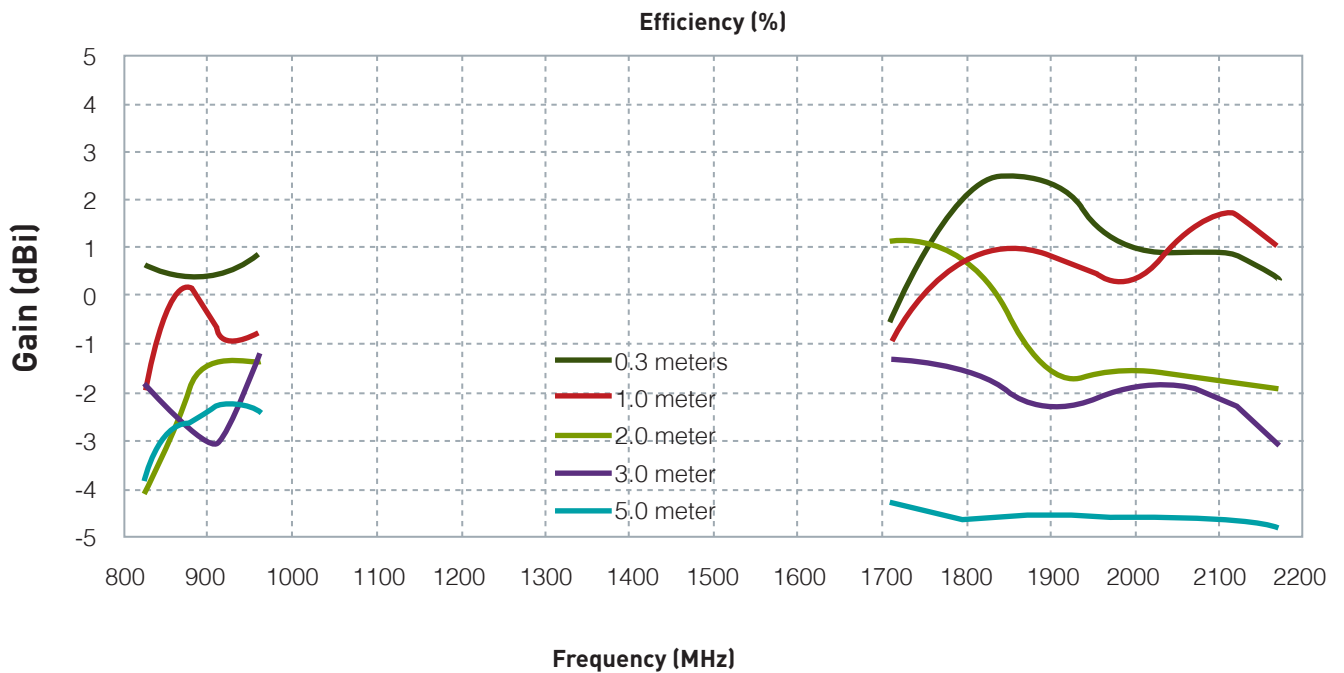

Figure 10. Gain of MA520 Cellular Antenna in free space.

4. Antenna Parameters

4.2 Gain

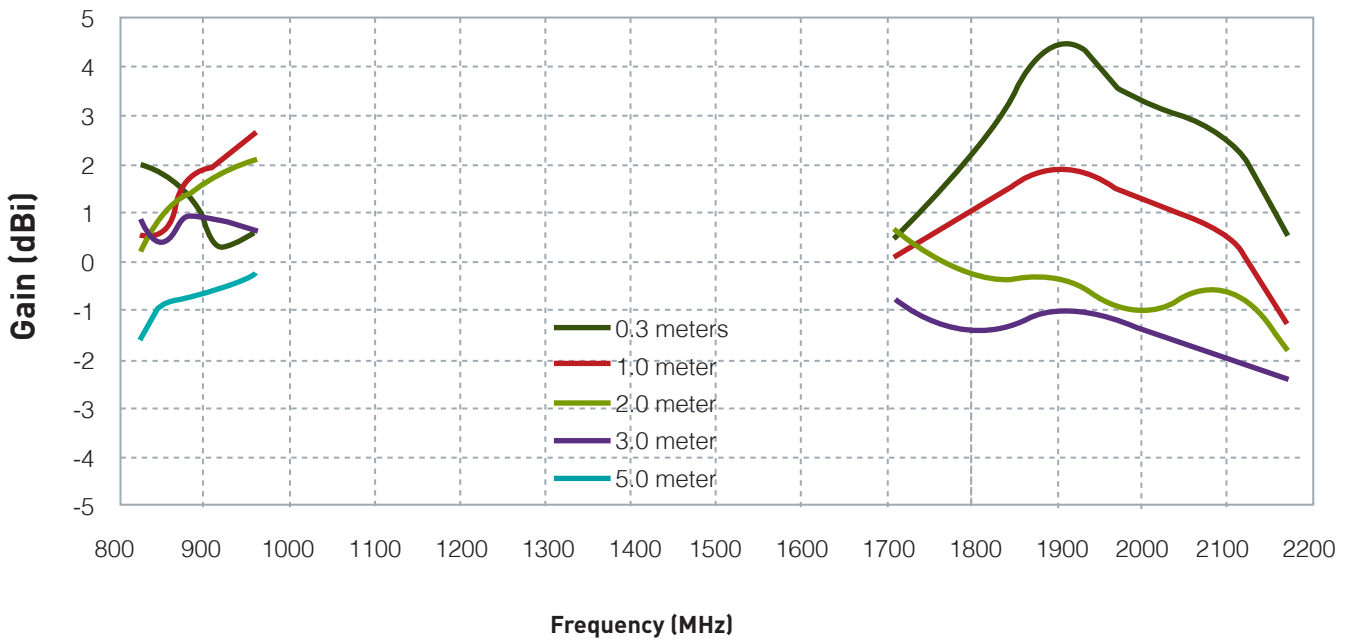

Figure 11. Gain of MA520 Cellular Antenna on 30*30 cm metal plate.

4.2 Gain

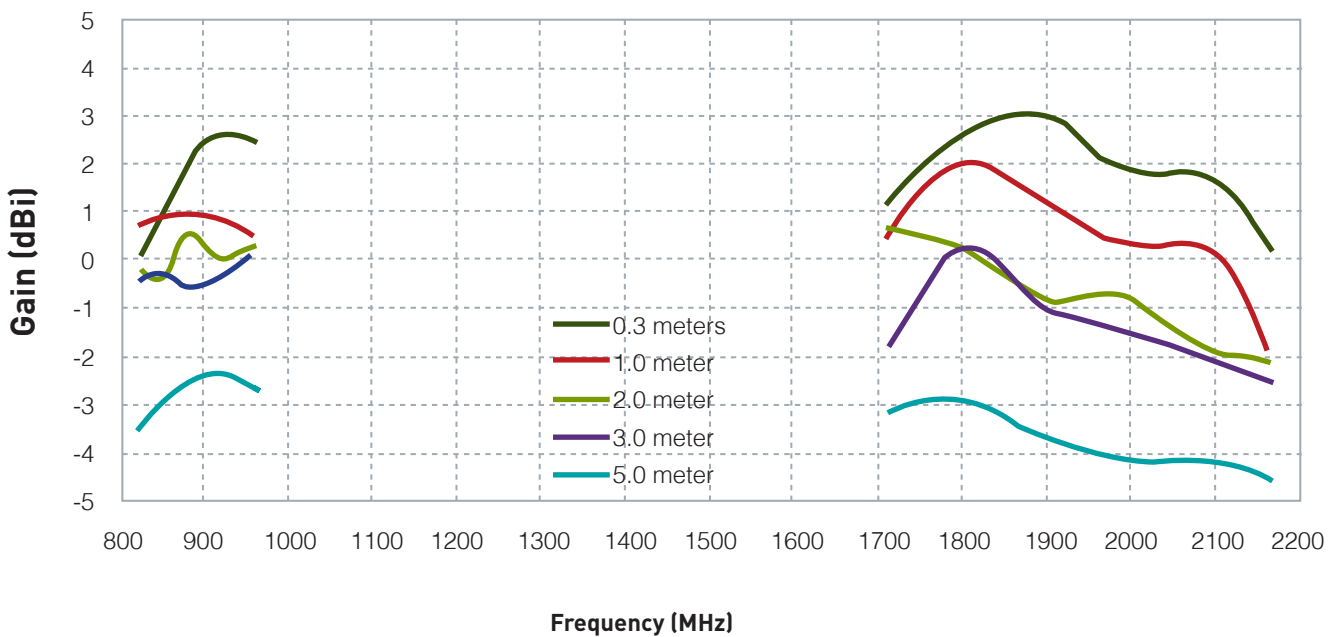

Figure 12. Gain of MA520 Cellular Antenna on 60*60 cm metal plate.

5. Radiation Pattern

5.1 Radiation Pattern (Free Space)

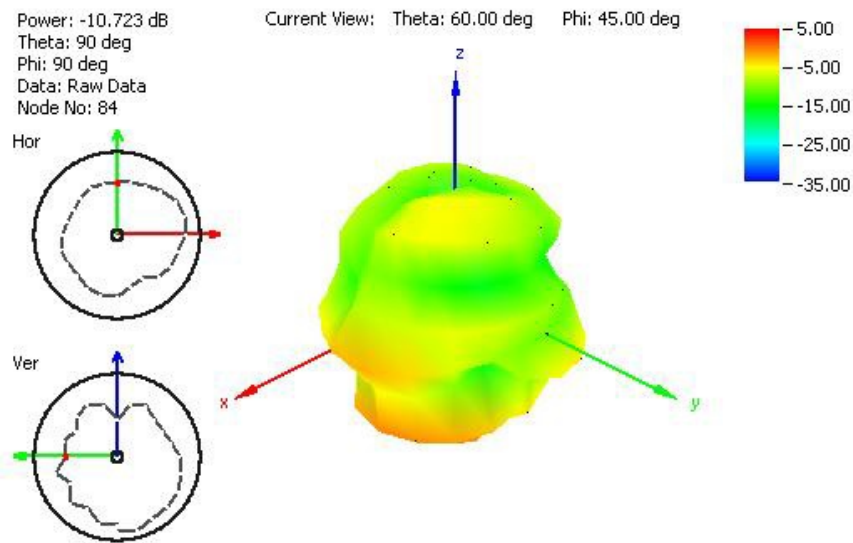

Figure 13. Radiation Pattern at 849 MHz in free space (cable length 2 meters).

5.1 Radiation Pattern (Free Space)

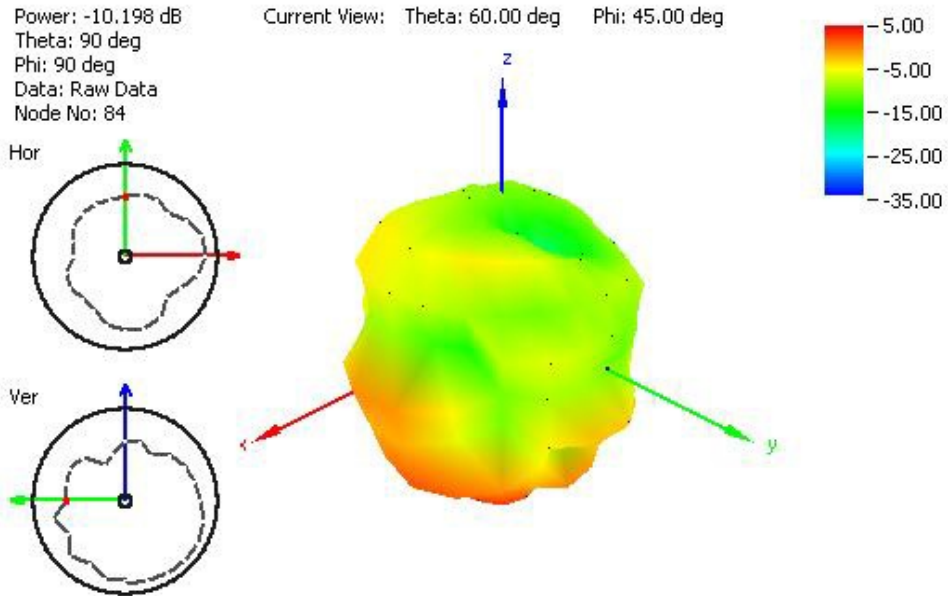

Figure 14. Radiation Pattern at 915 MHz in free space (cable length 2 meters).

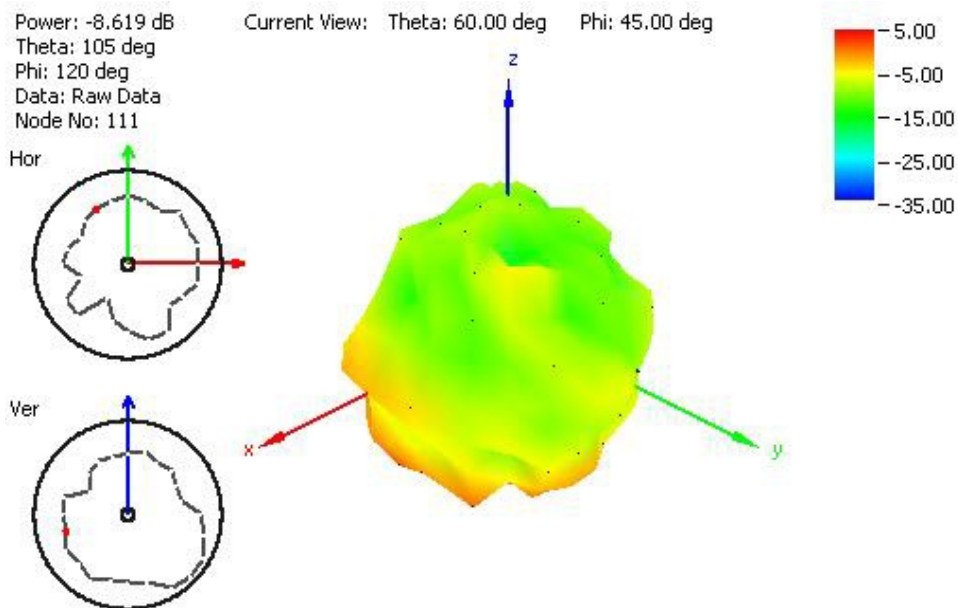

Figure 15. Radiation Pattern at 1805 MHz in free space (cable length 2 meters).

5.1 Radiation Pattern (Free Space)

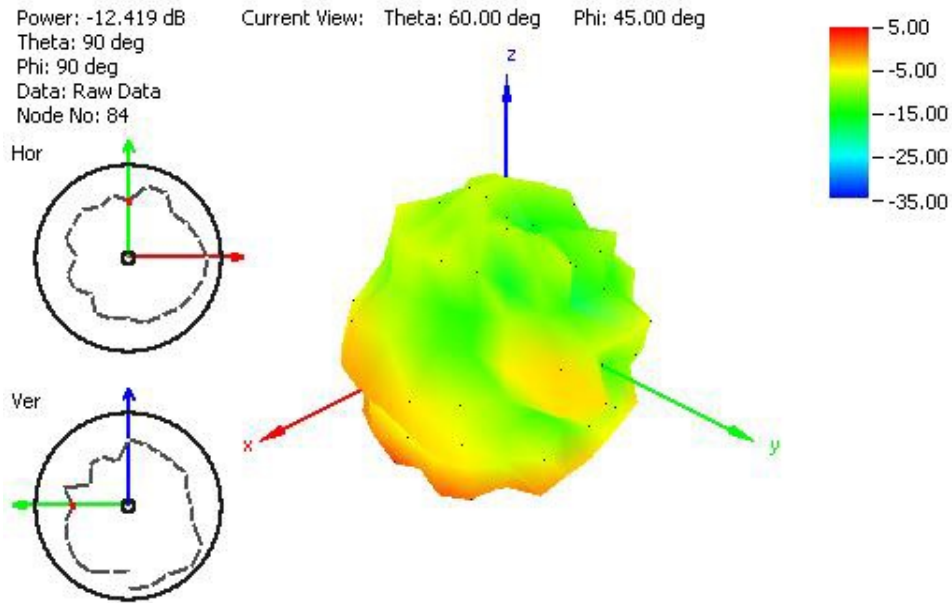

Figure 16. Radiation Pattern at 1910 MHz in free space (cable length 2 meters).

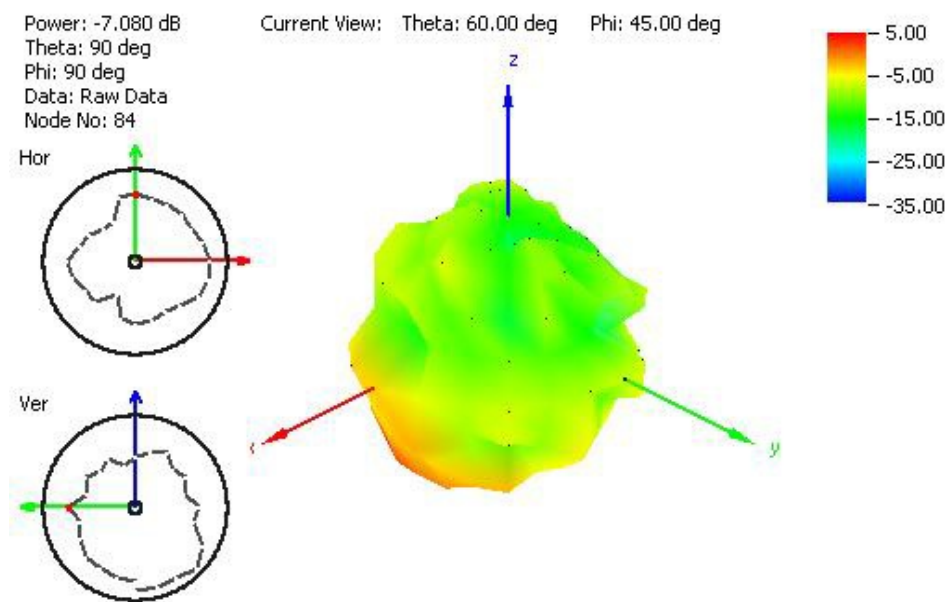

Figure 17. Radiation Pattern at 2110 MHz in free space (cable length 2 meters).

5.2 Radiation Pattern (30*30 mm Ground Plane)

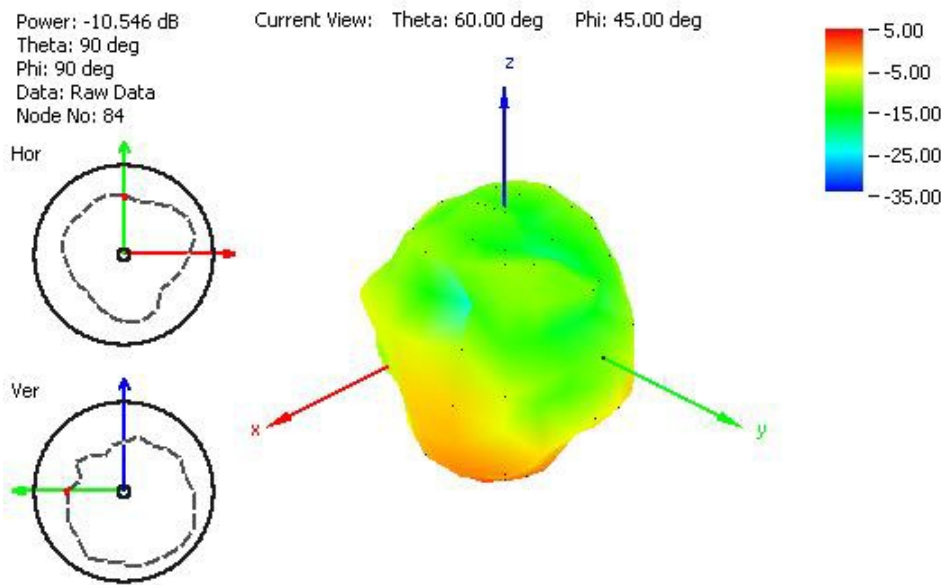

Figure 18. Radiation Pattern at 849 MHz (cable length 2 meters).

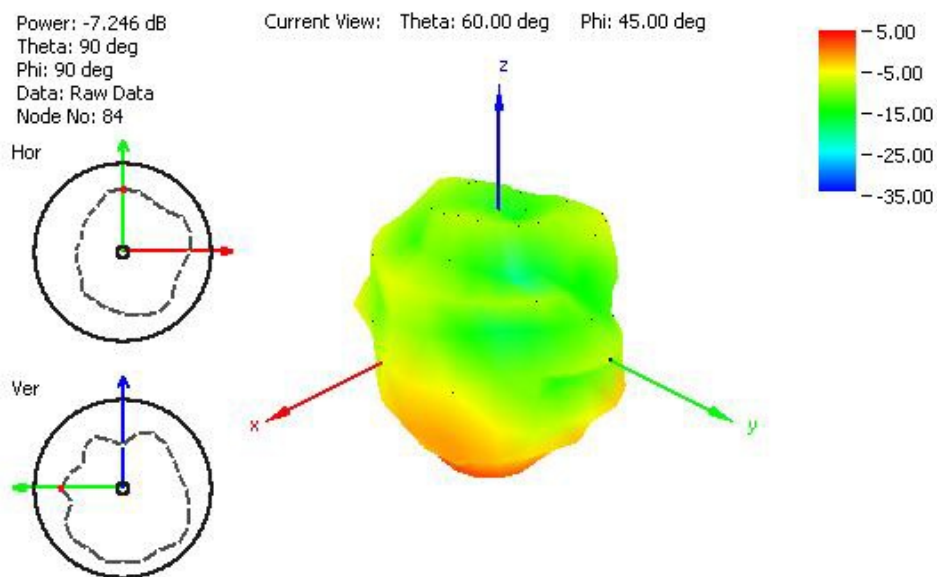

Figure 19. Radiation Pattern at 915 MHz (cable length 2 meters).

5.2 Radiation pattern

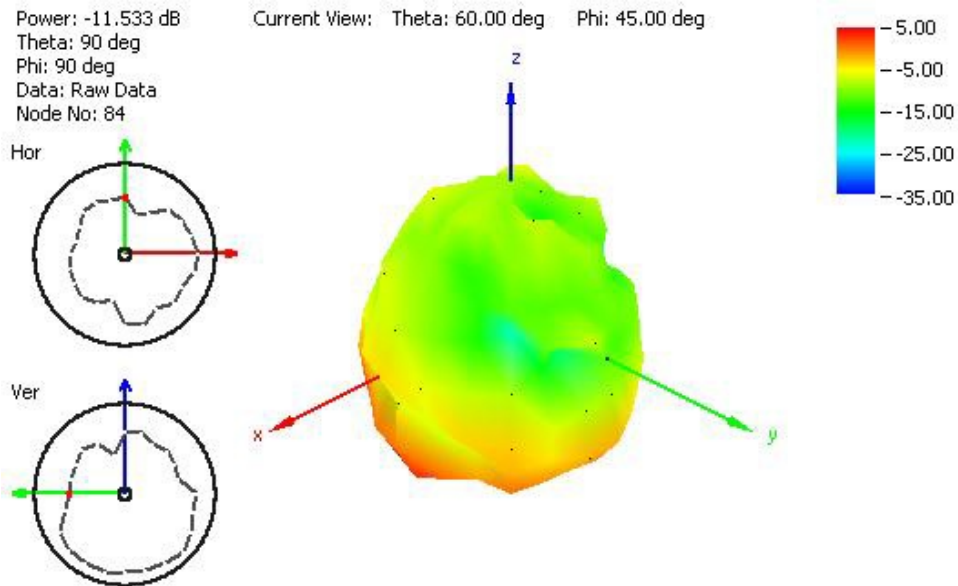

Figure 20. Radiation Pattern at 1805 MHz (cable length 2 meters).

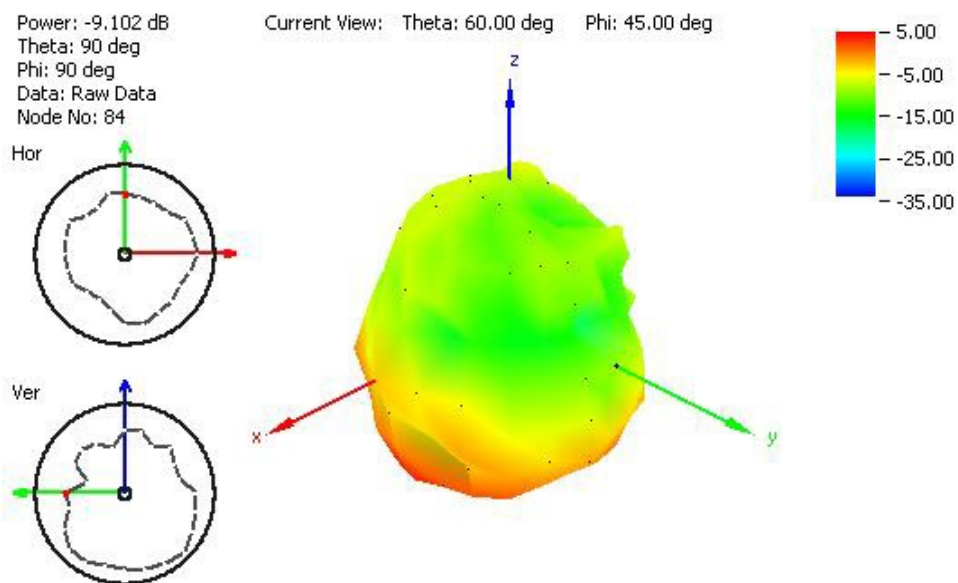

Figure 21. Radiation Pattern at 1910 MHz (cable length 2 meters).

5.2 Radiation pattern

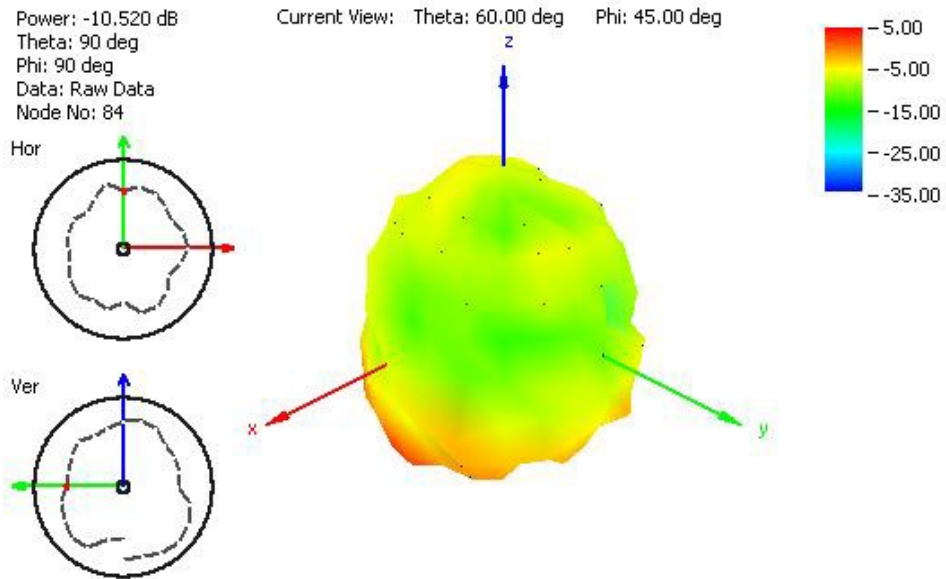

Figure 22. Radiation Pattern at 2110 MHz (cable length 2 meters).

5.3 Radiation Pattern (60 *60 mm Ground Plane)

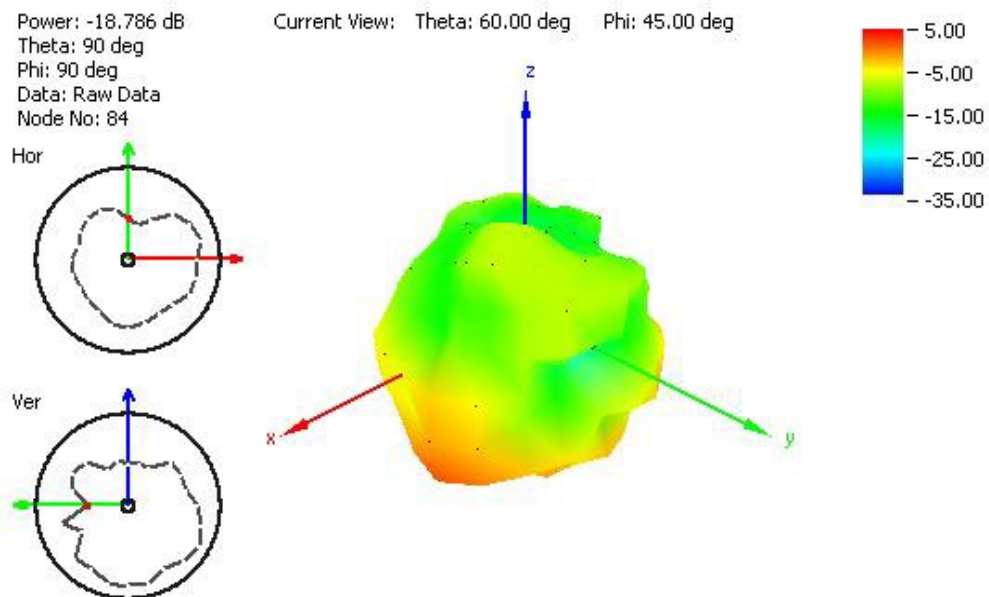

Figure 23. Radiation Pattern at 849 MHz (cable length 2 meters).

5.3 Radiation Pattern (60 *60 mm Ground Plane)

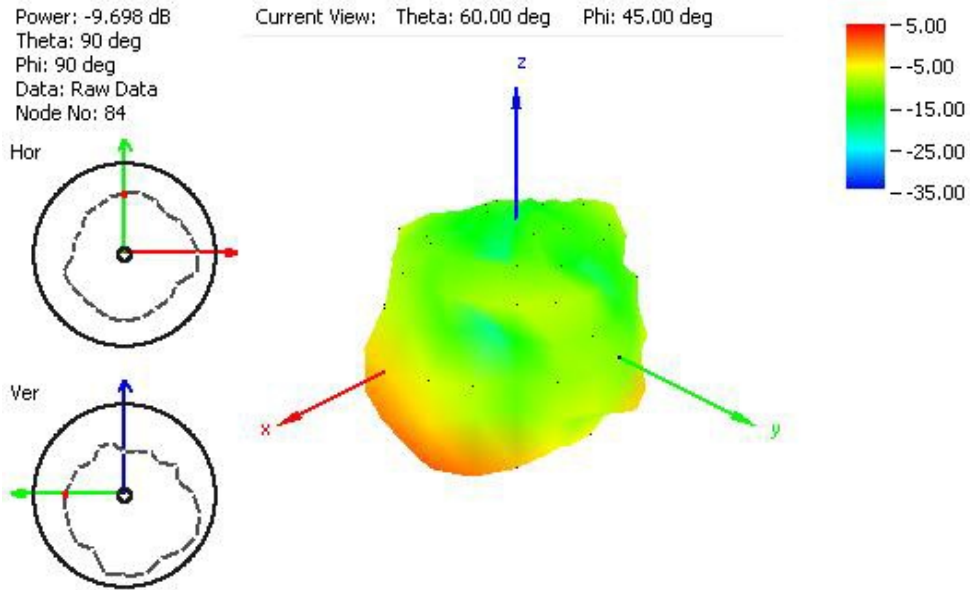

Figure 24. Radiation Pattern at 915 MHz (cable length 2 meters).

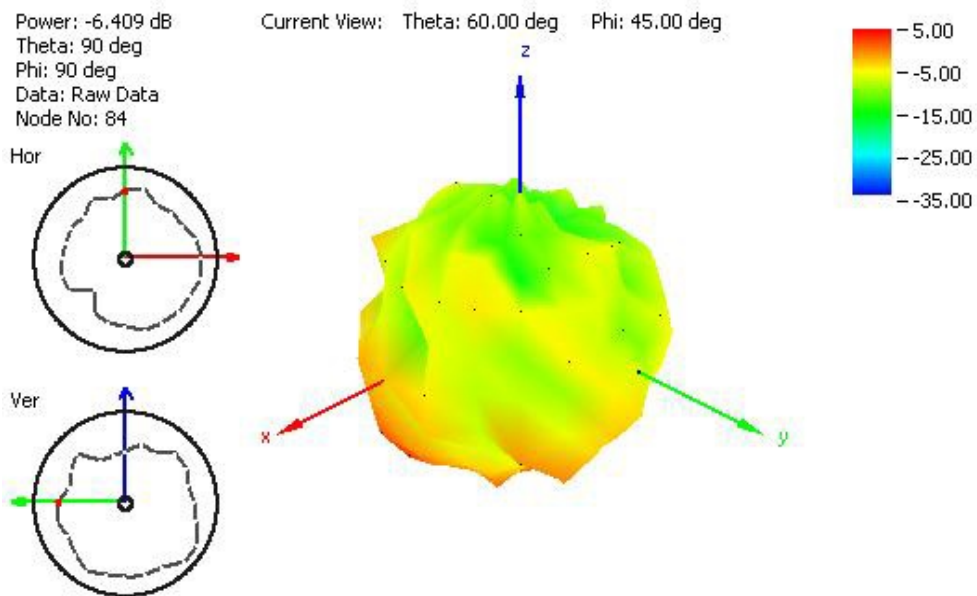

Figure 25. Radiation Pattern at 1805 MHz (cable length 2 meters).

5.3 Radiation Pattern (60*60 mm Ground Plane)

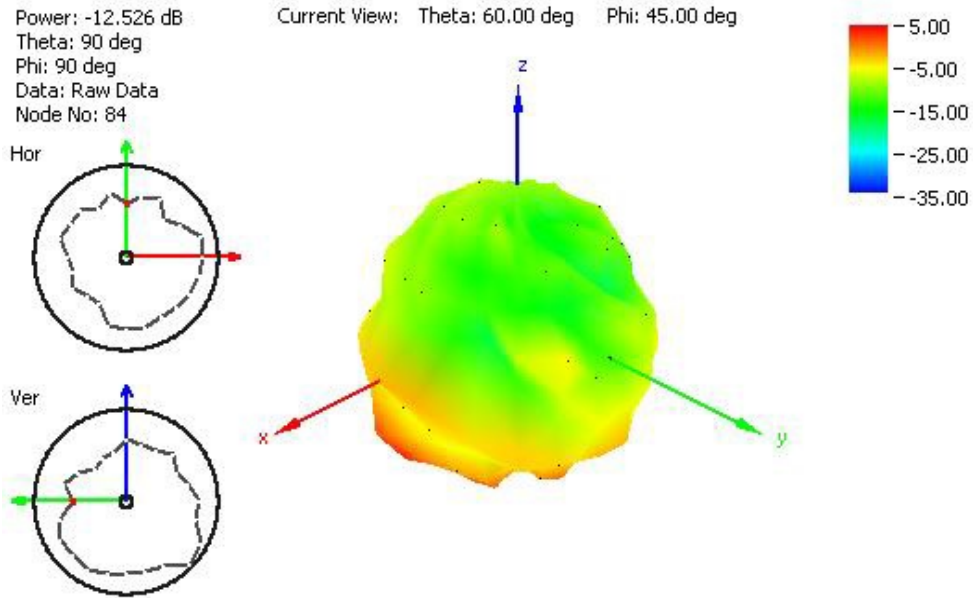

Figure 26. Radiation Pattern at 1910 MHz (cable length 2 meters).

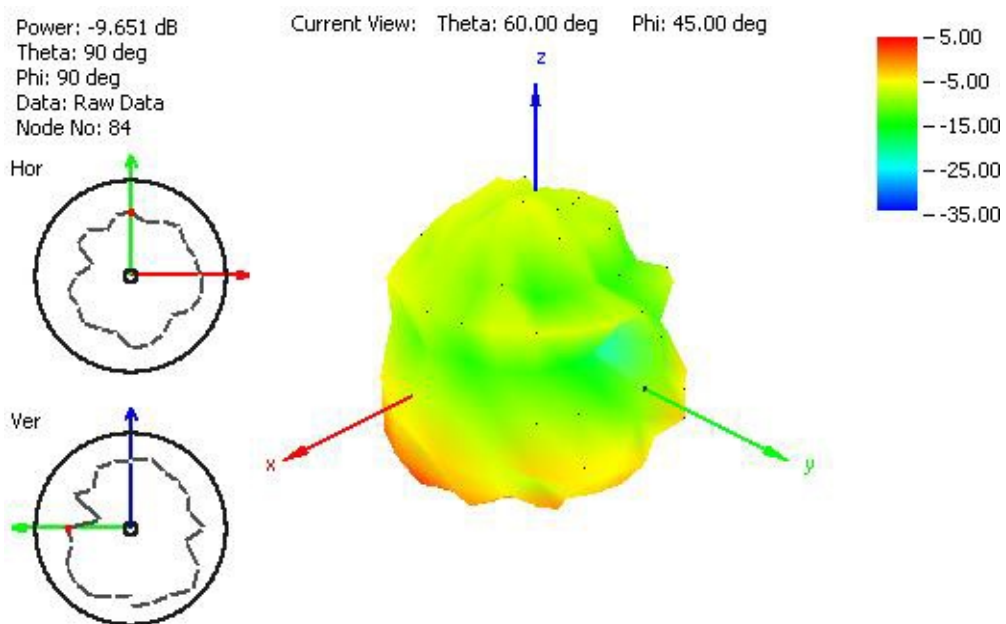

Figure 27. Radiation Pattern at 2110 MHz (cable length 2 meters).

5.4 Radiation Pattern 2.4/5 GHz (60 *60 mm Ground Plane)

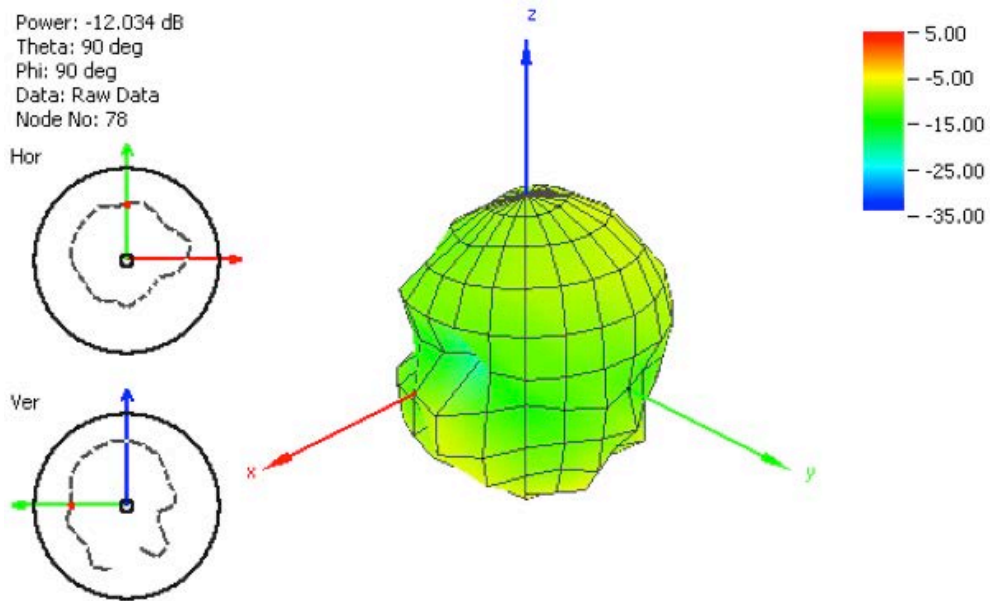

Figure 28. Radiation Pattern Antenna at 2450 MHz (cable length 2 meters)

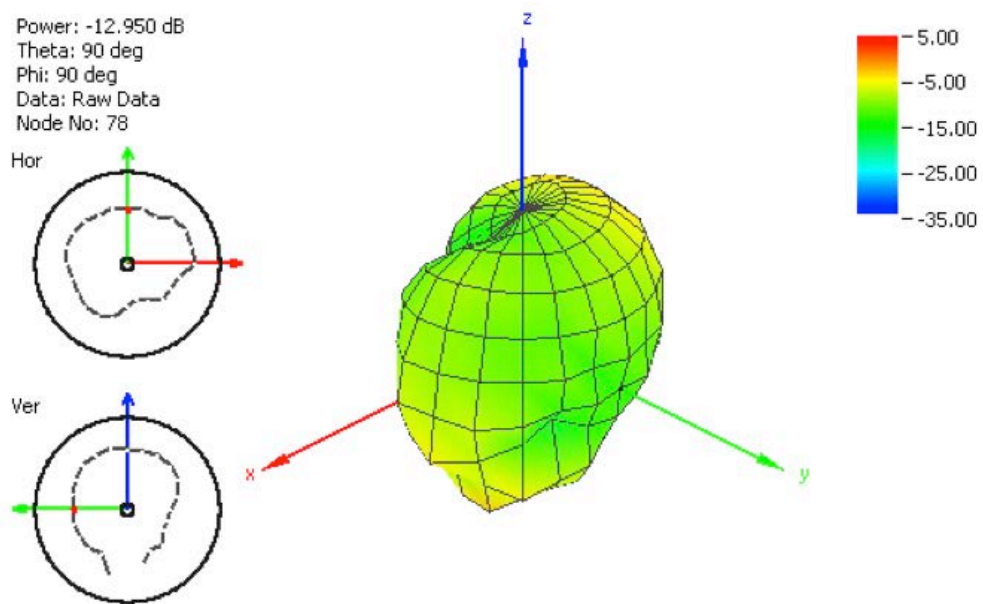
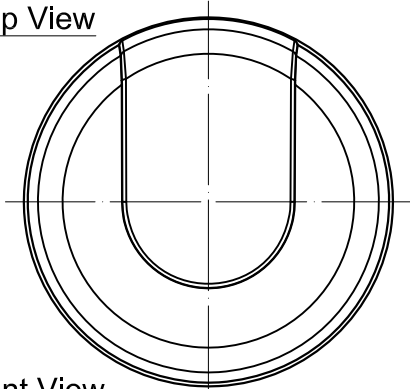

Figure 29. Radiation Pattern Antenna at 5500 MHz (cable length 2 meters)

6. Drawing

Top View



Front View

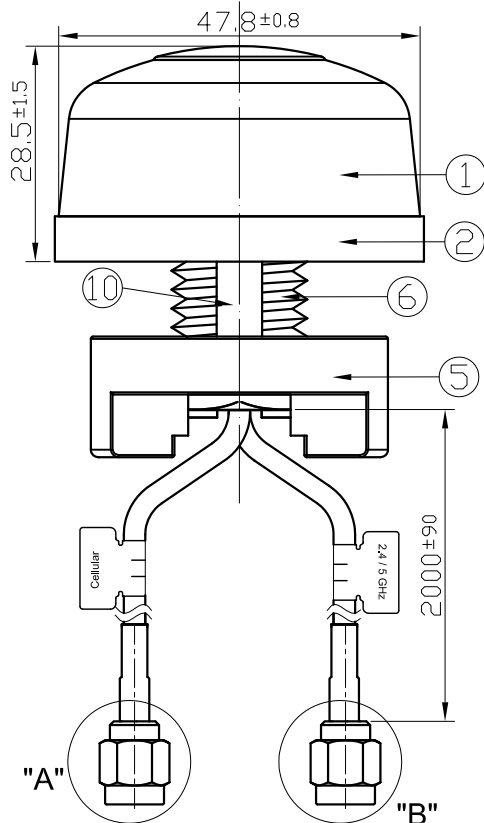

Side View

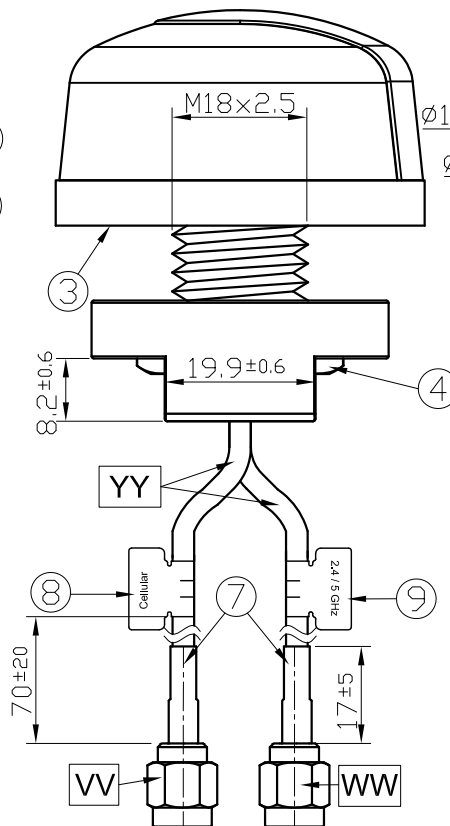

Bottom Thread View

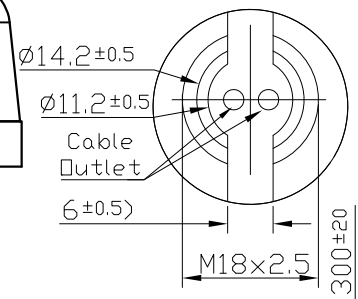

	Name	Material	Finish	QTY
1	Housing	ABS PA-707	Black	1
2	Closed Cell Foam	CR 4305	Black	1
3	3M Double Adhesive	3M 9448 WC	White Liner	1
4	M18 Inner Nut	Steel Carbon	Ni Plated	1
5	Outer Nut Cover	ABS	Black	1
6	M18x2.5 Thread 14.6L	Zinc Alloy	Ni Plated	1
7	Heat Shrink Tube	PE	Black	2
8	Cellular Label	Coated Paper	Orange	1
9	2.4/5GHz Label	Coated Paper	Green	1
10	Rubber Stopper	Rubber	Black	1

	Name	Spec	Finish	QTY
VV	Connector Type	SMA(M) ST	Gold	1
WW	Connector Type	SMA(M) RP ST	Gold	1
YY	Cable Type	RG316	Black	2

6.1 Connector Detail

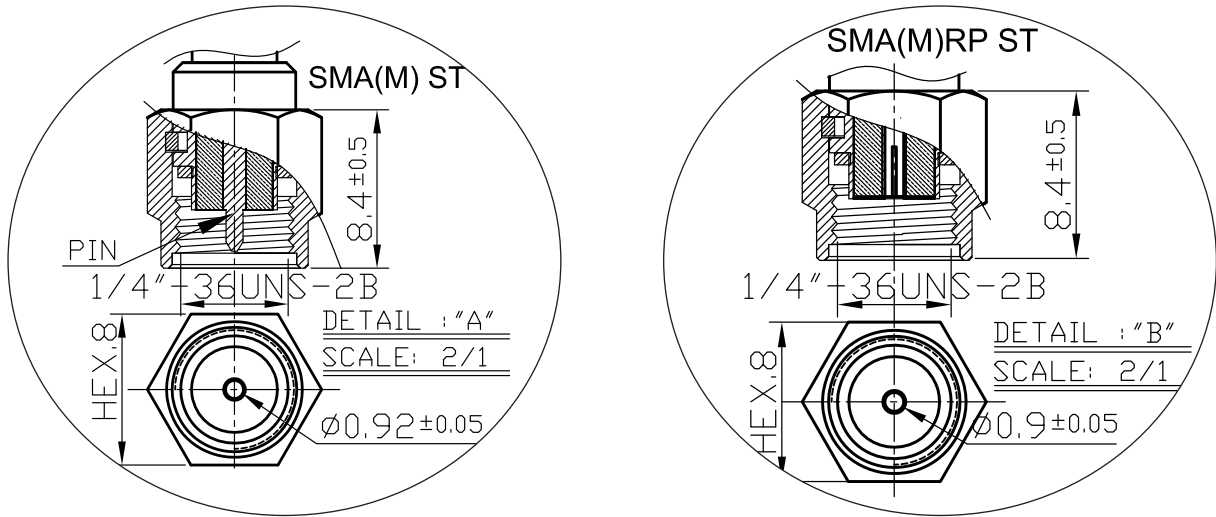

6.2 Installation

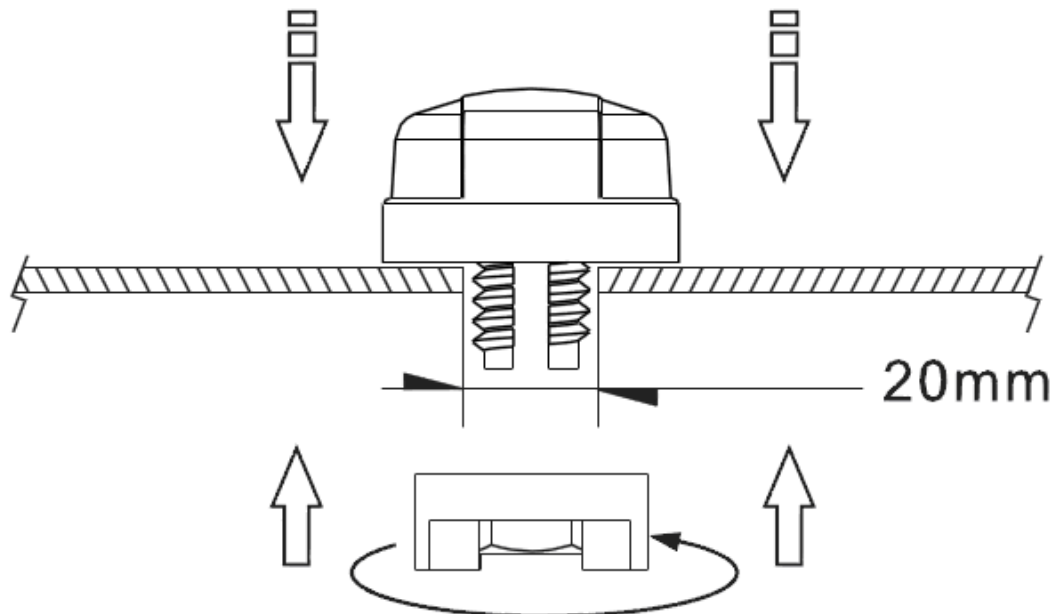

Recommended torque for mounting is 95Nm or 70ftlbs

Maximum torque for mounting is 135.6Nm or 100ft lbs

7. Packaging

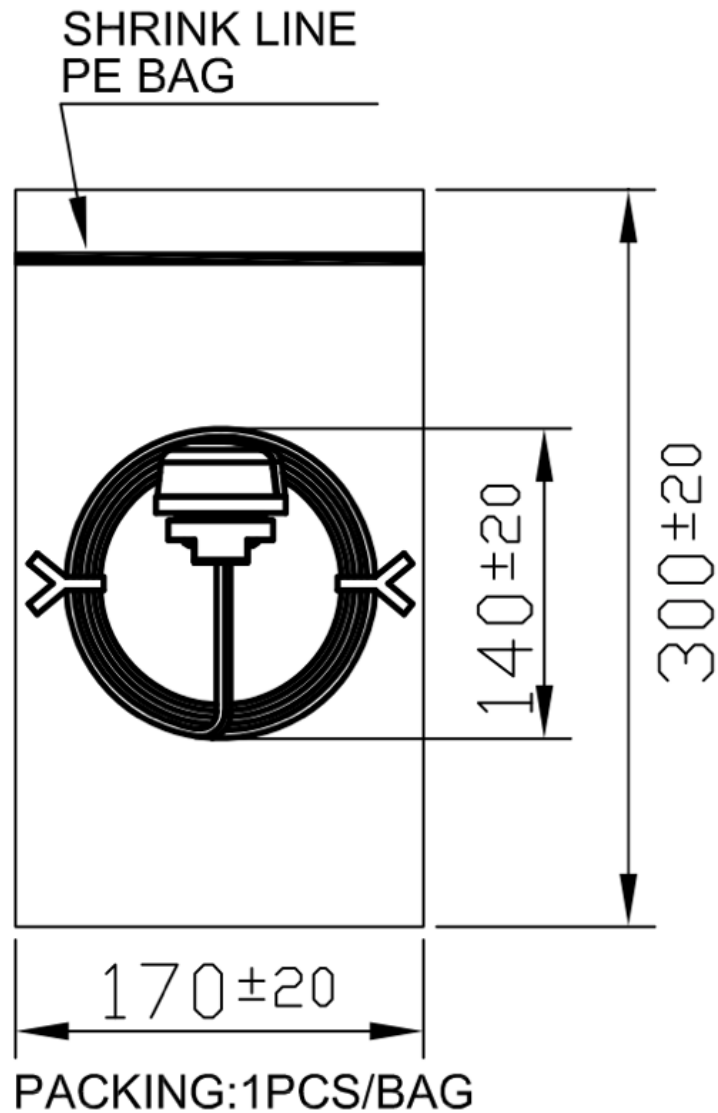

Taoglas makes no warranties based on the accuracy or completeness of the contents of this document and reserves the right to make changes to specifications and

product descriptions at any time without notice. Taoglas reserves all rights to this document and the information contained herein.

Reproduction, use or disclosure to third parties without express permission is strictly prohibited.
Copyright © Taoglas Ltd.