

**SBB SERIES**  
 Single Output

**HIGH RELIABILITY CLASS K HYBRID,  
 RADIATION HARDENED, NON-ISOLATED  
 POINT OF LOAD (POL) VOLTAGE REGULATOR**

**Description**

The SBB Series point of load (POL) DC to DC voltage regulators are high reliability hermetically sealed thick film hybrids designed to provide a single regulated DC output from a DC voltage source. The output power rating is 14W to 30W depending on output voltage, with maximum current rating of 14A. The POLs are class K qualified per MIL-PRF-38534. These products are designed to operate continuously on board a space craft up to the rated power output without power derating for case temperature of 85°C. The POLs are suitable for harsh radiation environments normally encountered in the geo-synchronous orbit (GEO), medium earth orbit (MEO), low earth orbit (LEO), deep space, and for other challenging radiation design applications.

The SBB POL is a non isolated synchronous buck regulator. It incorporates IR's heritage- rich components and circuit design library for long term reliability expected of system designs with a mission life of up to 18 years or more. The SBB Series of POLs operate from a DC input power source with the voltage range of 4.5V to 5.5V. It converts DC input voltage down to a fixed and highly stable DC output. The standard voltage outputs are 1.0V, 1.2V, 1.5V, 1.8V, 2.5V, and 3.3V. The output is adjustable with the addition of an external resistor. The output adjustment range is approximately ±10% of a nominal output voltage. Also included is remote sensing capability to compensate for voltage drops in the output lines. This feature, in combination with the output adjustment capability, enables an output voltage of a POL to be accurately set as needed.

With its excellent efficiency performance, SBB POLs are ideal as the point of load regulators for the distributed power architecture (DPA) design systems. Other key benefits include excellent dynamic load response, precise voltage setting, remote output voltage sensing and synchronization.



**Features**

- Total dose >100K Rads (Si)
- SEE hardness rated with LET > 82 MeV-cm<sup>2</sup>/mg
- Operates from 4.5V to 5.5V DC supply
- Fixed output voltage: 1V, 1.2V, 1.5V, 1.8V, 2.5V and 3.3V are standards
- Output power up to 30W or 14A maximum without de-rating
- High efficiency to 89%
- Remote sense compensation
- Fixed 400 KHz operating frequency
- Output adjustable to ±10% of nominal output with an external resistor
- Enable function pin for remote on/off control
- Input undervoltage and output under voltage protection
- Overload and short circuit protection
- Low noise with integrated input and output filters
- No external filter capacitors required
- Soft start
- Under voltage lockout (UVLO)
- Synchronization
- Output Status Telemetry (POK)
- -55 to +85°C operating case temperature without output power derating
- MIL-PRF-38534 element evaluated components
- Custom versions available
- Derating per MIL-STD-1547 for space flight
- MTBF > 2.8 million hours for space flight environments
- Standard Microcircuit Drawings (SMDs) Available

## SBB SERIES Single Output

International  
**IR** Rectifier

The product's package footprint is less than three square inches. The package and lid materials are cold rolled steel. The low profile package measures 1.9"L x 1.5"W x 0.335"H, excluding mounting tabs and input/output (I/O) pins. The ceramic sealed I/O pins protrude the package's side walls with the mounting tabs on the corners of the side walls. The I/O pins are copper Alloy 52. The pins are gold plated for long term storage. Gold is to be removed prior to assembly. A complete POL weighs less than 60 grams. Cooling of this device can be accomplished by bonding the base of the package to a metal plate or heat sink with a thermally conductive material. The package's mechanical outline and I/O pins functional assignment are included in this data sheet.

The SBB POLs are designed, manufactured, tested, and qualified at IR's facility in San Jose, California which is qualified to ISO9001 and MIL-PRF-38534 by DSCC. Flight hardware is 100% screened and fully compliant to class K per MIL-PRF-38534. Abbreviated screening version or engineering model (EM) of the SBB is available for engineering evaluation. Please refer to the Device Screening table for details.

### Circuit Description

The SBB Series POLs utilize a non-isolated buck circuit design topology with synchronous output rectification to maximize efficiency. The nominal switching frequency is 400 KHz. An internal EMI filter minimizes the reflected switching ripple current to meet most space applications at the system level. A two-stage output filter reduces the output ripple and noise to a very low level required by today's digital loads. No external filter capacitors are required for typical design applications.

Output current is limited under any load fault condition. It is designed to behave similar to a constant current source with the output voltage dropping below nominal. The SBB POL will resume normal operation when the load current is reduced below the current limit point. This protects the POL from both overload and short circuit conditions. The current limit threshold exhibits a negative temperature coefficient to reduce the possibility of thermal runaway.

**Undervoltage Lockout (UVLO):** An UVLO circuit prohibits the POL from operating when the line voltage is too low to maintain the output voltage. The POL will not start until the line input voltage rises to approximately 4.3 volts and will shut down when the input voltage drops below 3.9 volts.

**Output Voltage Adjustment:** The output voltage ( $V_{out}$ ) of an SBB can be adjusted to  $\pm 10\%$  of a nominal output voltage. One external resistor with a power rating of  $\geq 0.125$  watt is required for this function.

Following is the formula to determine an approximate value of the resistor and how it needs to be connected to the functional pins for a higher and a lower output voltage with respect to the nominal output voltage.

To reduce  $V_{out}$ , connect an adjust resistor to  $V_{adjust}$  pin and Output pin

$$R_{adj} = \left\{ \frac{\frac{11280 \times V_{out}}{V_{nom}} - 10280}{2 - \frac{2 \times V_{out}}{V_{nom}}} \right\}$$

To increase  $V_{out}$ , connect an adjust resistor to  $V_{adjust}$  pin and Output Return pin

$$R_{adj} = \left\{ \frac{\frac{9280 \times V_{out}}{V_{nom}} - 10280}{2 - \frac{2 \times V_{out}}{V_{nom}}} \right\}$$

Where:

$R_{adjust}$  is the value of the adjust resistor in Ohms( $\Omega$ )

$V_{nom}$  is the nominal output voltage of the SBB

**Remote Sense:** Output pins 4 and 5 must be connected to +Sense pin 6 for proper operation. The +Sense pin may be connected remotely to the output line at the load to compensate for a voltage drop in the output line for precise optimum output regulation. The maximum voltage compensation in combination with the output voltage adjustment (if required) is limited to 10% of the nominal output voltage. To enhance the load regulation performance Input Return (Pin 2) may be connected externally to Output Return (Pin 3).

**Enable:** An Enable pin is provided to remotely turn the POL on or off. It can also be used for output sequencing for multiple SBB POL regulators. The nominal threshold relative to the input return (pin 2) is 2.5V. If 3.9 volts or greater are applied to the Inhibit pin (pin 3) then the POL will operate normally. The pin may be left open for normal operation. A voltage of 0.4V or less will cause the SBB POL to shut down.

**Synchronization:** An external synchronization port is provided to allow the multiple SBB POLs to be synchronized to an external frequency source to minimize the noise interference coming from the switching operation of the POLs. The synchronization frequency ranges from 360 KHz to 440 KHz and the synchronization signal port can be driven from 5V logic.

**POK:** The SBB POL also provides a power ok (POK) output status signal at Pin 11. A logic high signal is present when the POL's output voltage is greater than 95% of the nominal output voltage. A logic low signal at Pin 11 indicates the POL's output voltage drops below the output voltage threshold of 95%

The SBB Series POLs use a proven conservative design methodology with careful incorporation of known radiation performance devices and established reliability components. All components are fully derated to MIL-STD-1547. Standard design analyses include stress, thermal, failure modes and effects (FMEA), reliability & worst case and are available upon request.

Absolute Maximum Ratings		Recommended Operating Conditions	
Input voltage range	-0.5Vdc to +7.0Vdc	Input voltage range	4.5Vdc to 5.5Vdc
Output power	Internally limited	Output power	0 to Max. Rated
Lead temperature	300°C for 10 seconds		
Operating case temperature	-55°C to +125°C	Operating case temperature <sup>1</sup>	-55°C to +85°C
Storage temperature	-55°C to +125°C	Storage temperature	-55°C to +125°C

<sup>1</sup> Meets derating per MIL-STD-1547

### Electrical Performance Characteristics

Parameter	Group A Subgroup	Conditions -55°C ≤ T <sub>C</sub> ≤ +85°C V <sub>IN</sub> = 5.0V DC ± 5%, C <sub>L</sub> = 0 unless otherwise specified	Limits			Unit
			Min	Nom	Max	
Input Voltage			4.5	5.0	5.5	V
Output Voltage (V <sub>OUT</sub> )						
SBB501S	1	I <sub>OUT</sub> = 100% rated load	0.985	1.000	1.015	V
SBB501R2S	1		1.182	1.200	1.218	
SBB501R5S	1		1.478	1.500	1.523	
SBB501R8S	1		1.773	1.800	1.827	
SBB502R5S	1		2.463	2.500	2.538	
SBB503R3S	1		3.251	3.300	3.350	
SBB501S	2,3	I <sub>OUT</sub> = 100% rated load	0.970		1.030	
SBB501R2S	2,3		1.164		1.236	
SBB501R5S	2,3		1.462		1.537	
SBB501R8S	2,3		1.755		1.855	
SBB502R5S	2,3		2.450		2.550	
SBB503R3S	2,3		3.234		3.366	
Output power (P <sub>OUT</sub> )						
SBB501S	1,2,3	V <sub>IN</sub> = 4.5, 5.0 and 5.5V, Note 2			14	W
SBB501R2S					16.8	
SBB501R5S					21	
SBB501R8S					25.2	
SBB502R5S					30	
SBB503R3S					30	
Output current (I <sub>OUT</sub> )						
SBB501S	1,2,3	V <sub>IN</sub> = 4.5, 5.0 and 5.5V, Note 2	0		14	A
SBB501R2S			0		14	
SBB501R5S			0		14	
SBB501R8S			0		14	
SBB502R5S			0		12	
SBB503R3S			0		9.1	
Line regulation (VR <sub>LINE</sub> )	1,2,3	V <sub>IN</sub> = 4.5, 5.0, 5.5 Volts I <sub>OUT</sub> = 0, 50%, 100% rated	-0.25		0.25	%
Load regulation (VR <sub>LOAD</sub> )						
SBB501S	1,2,3	V <sub>IN</sub> = 4.5, 5.0, 5.5 Volts I <sub>OUT</sub> = 0, 50%, 100% rated	-15		15	mV
SBB501R2S			-15		15	
SBB501R5S			-15		15	
SBB501R8S			-15		15	
SBB502R5S			-13		17	
SBB503R3S			-17		17	
Switching frequency (F <sub>S</sub> )	1,2,3	Sync Input (Pin 9) open	360	400	440	KHz

For Notes to Electrical Performance Characteristics Table, refer to page 6

**Electrical Performance Characteristics ( continued )**

Parameter	Group A Subgroup	Conditions -55°C ≤ T <sub>C</sub> ≤ +85°C V <sub>IN</sub> = 5.0V DC ± 5%, C <sub>L</sub> = 0 unless otherwise specified	Limits			Unit
			Min	Nom	Max	
Input current (I <sub>IN</sub> ) SBB501S SBB501R2S SBB501R5S SBB501R8S SBB502R5S SBB503R3S		I <sub>OUT</sub> = 0, Pin 10 open		130	200	mA
		Pin 10 shorted to pin 2		40	50	
Output ripple (V <sub>RRIP</sub> ) SBB501S SBB501R2S SBB501R5S SBB501R8S SBB502R5S SBB503R3S	1,2,3	V <sub>IN</sub> = 4.5, 5.0, 5.5 Volts I <sub>OUT</sub> = 100% rated load, Note 3			30 30 30 30 25 20	mV p-p
Efficiency (E <sub>EFF</sub> ) SBB501S SBB501R2S SBB501R5S SBB501R8S SBB502R5S SBB503R3S	1,2,3	I <sub>OUT</sub> = 100% rated load	67 70 73 76 82 86			%
Enable Input (Inhibit Function) Open circuit voltage Drive current (sink) Voltage range	1,2,3	Note 1	V <sub>IN</sub> - 0.8  -0.5		V <sub>IN</sub> 500 50	V μA V
Synchronization Input Frequency range Pulse high level Pulse low level Pulse transition time Pulse duty cycle	1,2,3	External clock for Sync Input (Pin 9) Note 1	360 Vin -0.5 -0.5  20		440 Vin +0.5 +0.5 50 80	KHz V V nS %
Current Limit point SBB501S SBB501R2S SBB501R5S SBB501R8S SBB502R5S SBB503R3S	1,2,3	V <sub>OUT</sub> = 90% of Nominal	14.5 14.5 14.5 14.5 12.5 9.5		21.5 21.5 21.5 21.5 17.9 13.7	A
Power dissipation, load fault (P <sub>D</sub> ) SBB501S SBB501R2S SBB501R5S SBB501R8S SBB502R5S SBB503R3S	1,2,3	Short Circuit, Overload, Note 5			11 11 11 11 9.5 8.0	W
Output response to Step load changes (V <sub>TLD</sub> ) SBB501S SBB501R2S SBB501R5S SBB501R8S SBB502R5S SBB503R3S	4,5,6	Half Load to/from Full Load, Note 6	-150 -150 -150 -150 -200 -200		150 150 150 150 200 200	mV

For Notes to Electrical Performance Characteristics Table, refer to page 6

**Electrical Performance Characteristics ( continued )**

Parameter	Group A Subgroup	Conditions -55°C ≤ T <sub>C</sub> ≤ +85°C V <sub>IN</sub> = 5.0V DC ± 5%, C <sub>L</sub> = 0 unless otherwise specified	Limits			Unit
			Min	Nom	Max	
Recovery time, step load changes (T <sub>TLD</sub> )	4,5,6	Half Load to/from Full Load, Notes 6,7			200	µs
Output response to step line changes (V <sub>TLN</sub> )	4,5,6	4.5V to/from 5.5V I <sub>OUT</sub> = 100% rated load, Notes 1, 8	-100		100	mV pk
Recovery time, step line changes (T <sub>TLN</sub> )	4,5,6	4.5V to/from 5.5V I <sub>OUT</sub> = 100% rated load, Notes 1,7,8			200	µs
Turn-on Response Overshoot (V <sub>OS</sub> ) Turn-on Delay (T <sub>DLY</sub> )	4,5,6	No Load, Full Load, Note 9	0.5		100 10	mV ms
Capacitive Load (C <sub>L</sub> )	1	I <sub>OUT</sub> = 100% rated load No effect on DC performance Notes 1, 4			10000	µF
Line Rejection	1	I <sub>OUT</sub> = 100% rated load DC to 50KHz, Note 1	28			dB
Device Weight					60	g
MTBF		MIL-HDBK-217F2, SF, 40°C	2.8 x 10 <sup>6</sup>			Hr

**Electrical Performance Characteristics - Notes**

- Parameter is tested as part of design characterization or after design changes. Thereafter, parameter shall be guaranteed to the limits specified.
- Parameter verified during line and load regulation tests.
- Guaranteed for a D.C. to 20MHz bandwidth. Tested using a 20KHz to 10MHz bandwidth.
- Capacitive load may be any value from 0 to the maximum limit without compromising dc performance. A capacitive load in excess of the maximum limit may cause erratic behavior during turn-on.
- Overload power dissipation is defined as the device power dissipation with the load set such that V<sub>OUT</sub> = 90% of nominal.
- Load step transition time ≤ 1.0 µs/A for 3.3V & 2.5V models and ≤ 0.1 µs/A for 1.0V, 1.2V, 1.5V & 1.8V models.
- Recovery time is measured from the initiation of the transient to where V<sub>OUT</sub> has returned to within ±1% of its steady state value.
- Line step transition time ≤ 10 µs.
- Turn-on delay time from either a step application of input power or a logic low to a logic high transition on the Enable pin (pin 10) to the point where V<sub>OUT</sub> = 90% of nominal.

**Radiation Performance Characteristics**

Test	Conditions	Min	Typ	Unit
Total Ionizing Dose ( Gamma )	MIL-PRF-883, Method 1019 Operating bias applied during exposure, 2 / 3 Rated Load, V <sub>IN</sub> = 5.0V	100		Krads (Si)
Single Event Effects SEU, SEL, SEGR, SEB	Heavy ions (LET) Operating bias applied during exposure, Full Rated Load, V <sub>IN</sub> = 5.5V <b>Test lab: Cyclotron Institute, Texas A &amp; M University</b>	82		MeV·cm <sup>2</sup> /mg

Notes: International Rectifier currently does not have a DLA Land and Maritime (formerly DSCC) certified Radiation Hardness Assurance Program.

**Block Diagram**

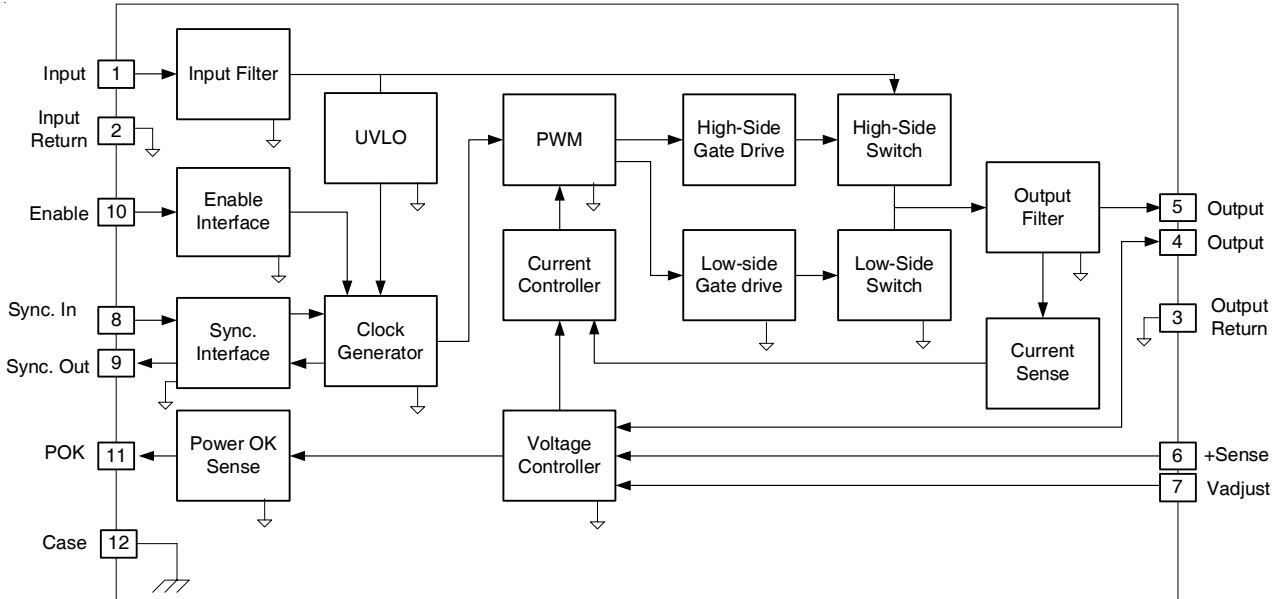

**Fig 1: Typical Efficiency @-55°C - 1.2V Output (For Part Number SBB501R2S)**

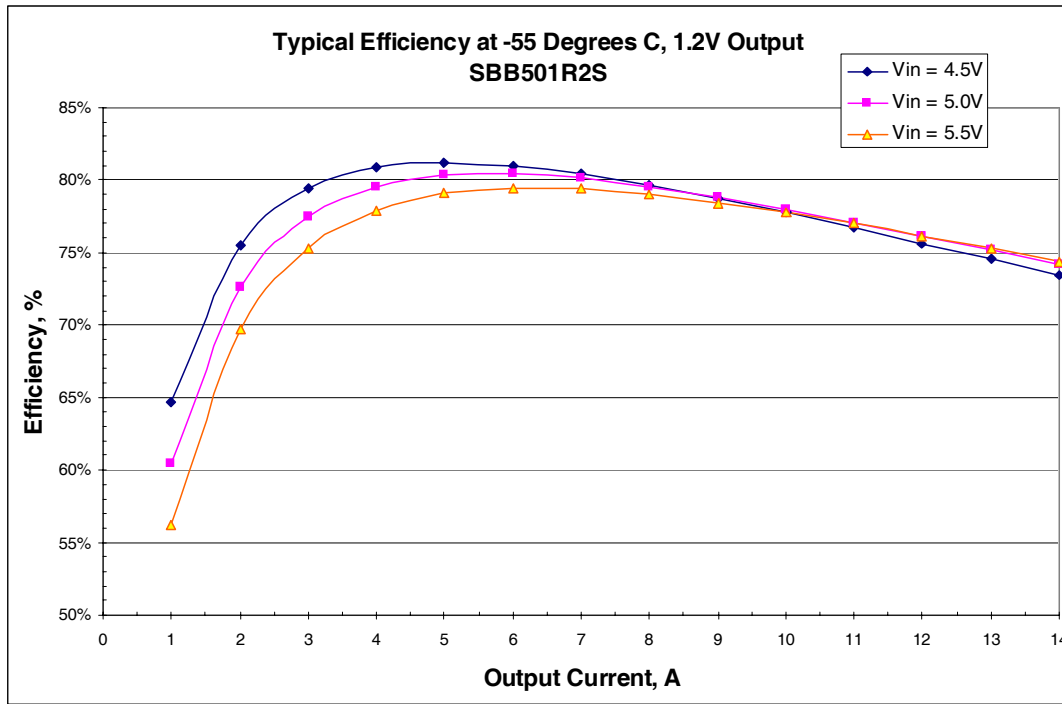

**Fig 2: Typical Efficiency @25°C - 1.2V Output (For Part Number SBB501R2S)**

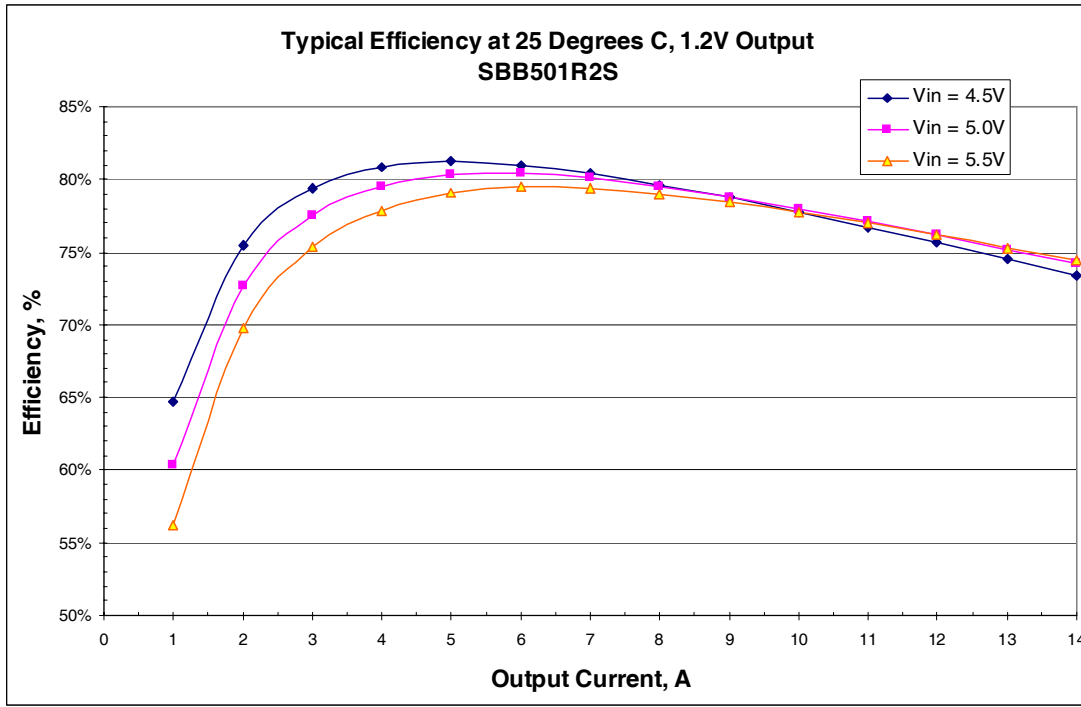

**Fig 3: Typical Efficiency @+85°C - 1.2V Output (For Part Number SBB501R2S)**

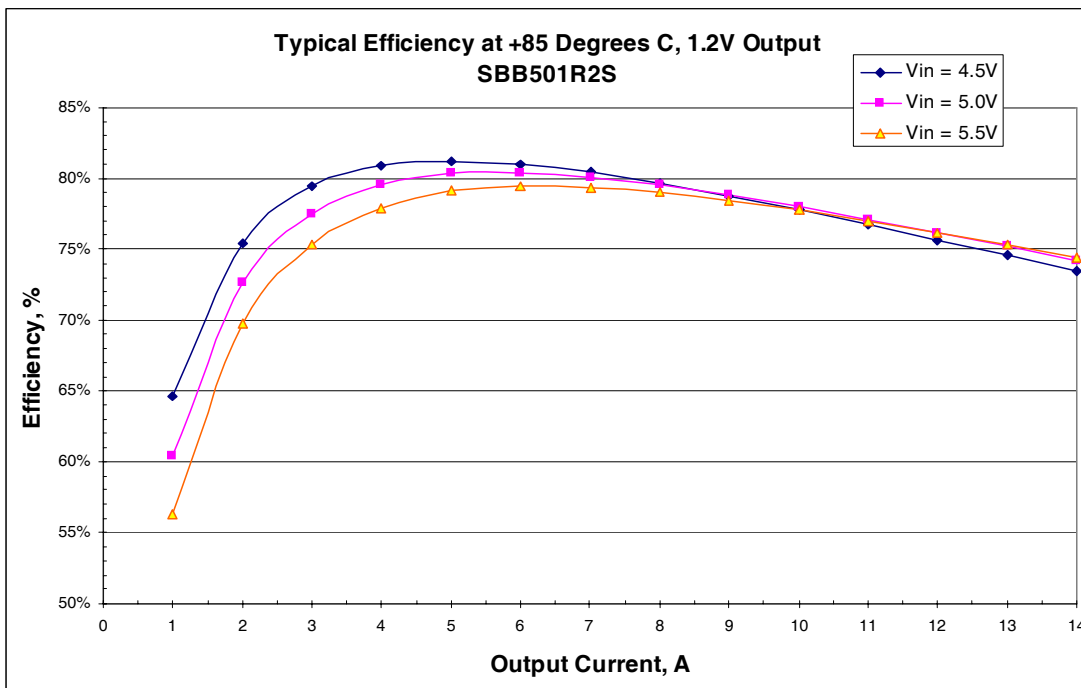



Fig 4: Typical Efficiency @ 25°C - 1.5V Output (For Part Number SBB501R5S)

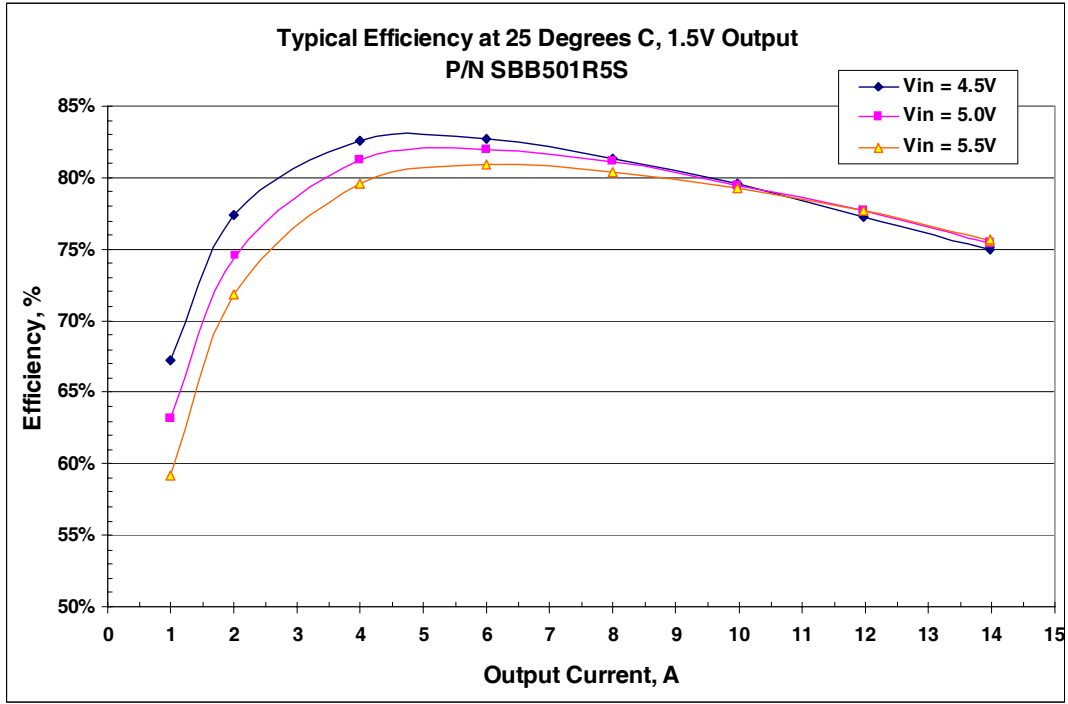
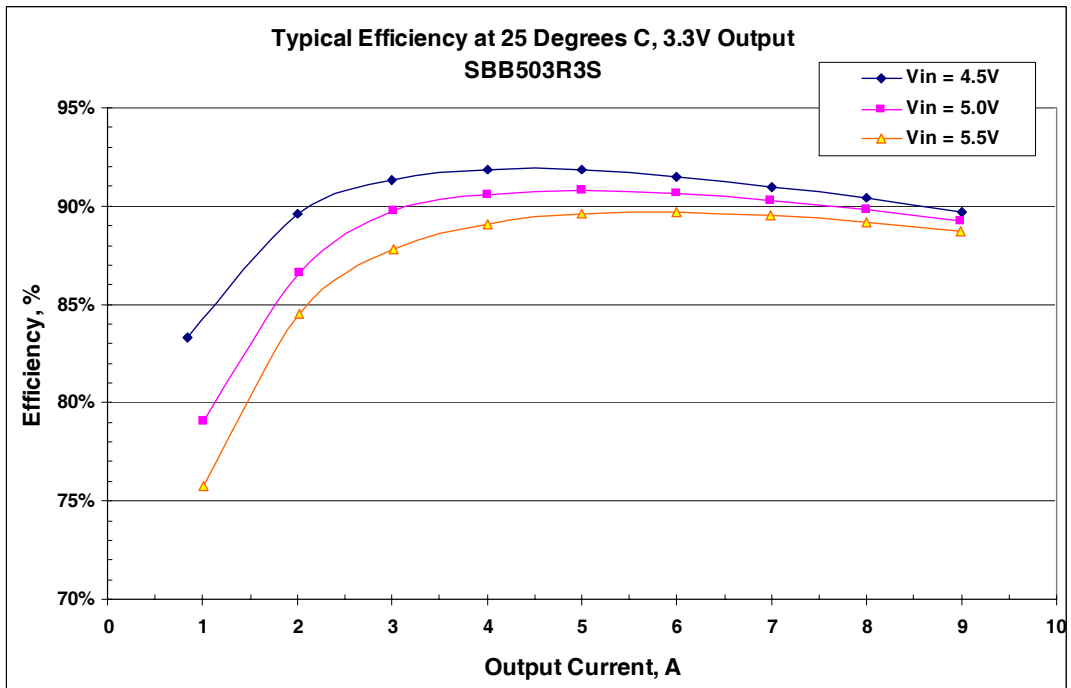
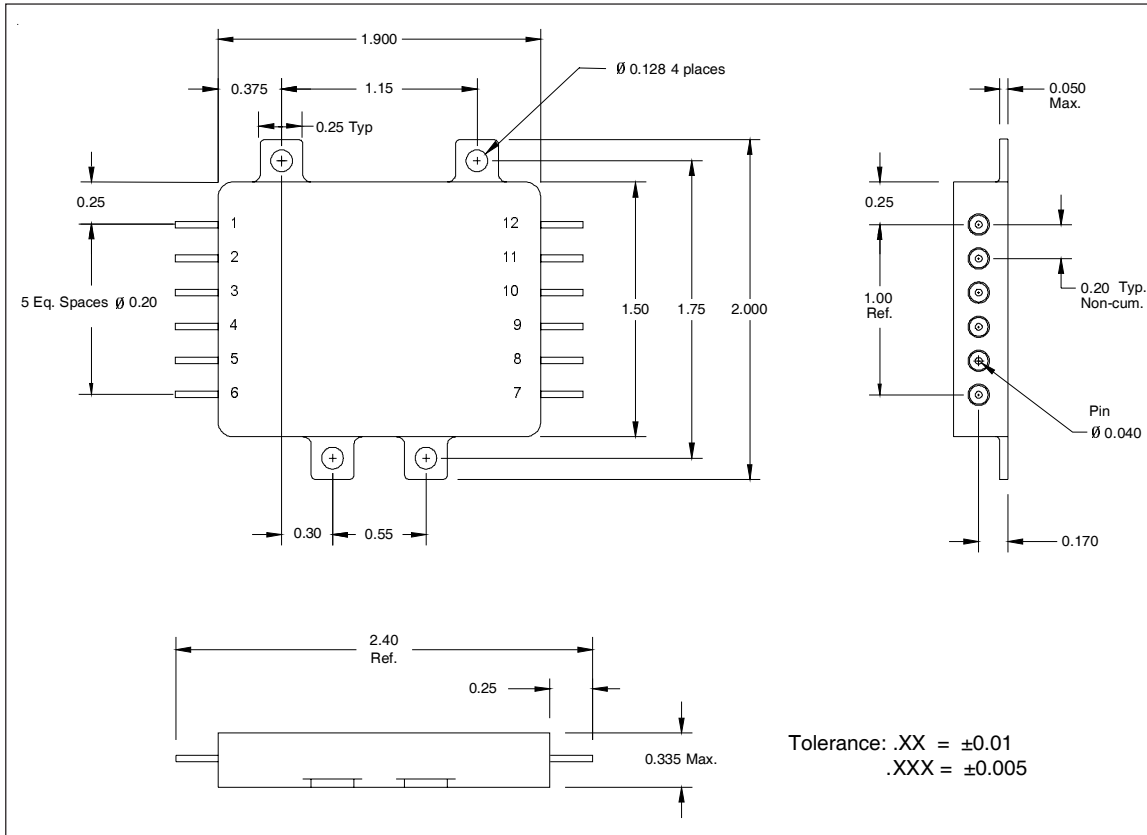

Fig 5: Typical Efficiency @ 25°C - 3.3V Output (For Part Number SBB503R3S)



**SBB SERIES**  
**Single Output**

**Mechanical Outline**



**Pin Designation**

Pin #	Designation
1	Input
2	Input Return
3	Output Return
4	Output
5	Output
6	+Sense
7	Vadjust
8	Sync In
9	Sync Out
10	Enable
11	POK
12	Case

Note: Input and output returns are internally connected

**Standard Microcircuit Drawing Equivalence Table**

Standard Microcircuit Drawing Number	IR Standard Part Number
5962-1120601KXA	SBB501S/CKA
5962-1120601KXC	SBB501S/CKC
5962-1120602KXA	SBB501R2S/CKA
5962-1120602KXC	SBB501R2S/CKC
5962-1120603KXA	SBB501R5S/CKA
5962-1120603KXC	SBB501R5S/CKC
5962-1120604KXA	SBB501R8S/CKA
5962-1120604KXC	SBB501R8S/CKC
5962-1120605KXA	SBB502R5S/CKA
5962-1120605KXC	SBB502R5S/CKC
5962-1120606KXA	SBB503R3S/CKA
5962-1120606KXC	SBB503R3S/CKC

**Device Screening**

Requirement	MIL-STD-883 Method	No Suffix ②	CK ②	EM
Temperature Range	—	-55°C to +85°C	-55°C to +85°C	-55°C to +85°C
Element Evaluation	MIL-PRF-38534	Class K	Class K	N/A
Non-Destructive Bond Pull	2023	Yes	Yes	N/A
Internal Visual	2017	Yes	Yes	①
Temperature Cycle	1010	Cond C	Cond C	Cond C
Constant Acceleration	2001, Y1 Axis	3000 Gs	3000 Gs	3000 Gs
PIND	2020	Cond A	Cond A	N/A
Burn-In	1015	320 hrs @ 125°C ( 2 x 160 hrs )	320 hrs @ 125°C ( 2 x 160 hrs )	48 hrs @ 125°C
Final Electrical ( Group A )	MIL-PRF-38534 & Specification	-55°C, +25°C, +85°C	-55°C, +25°C, +85°C	-55°C, +25°C, +85°C
PDA	MIL-PRF-38534	2%	2%	N/A
Seal, Fine and Gross	1014	Cond A, C	Cond A, C	Cond A
Radiographic	2012	Yes	Yes	N/A
External Visual	2009	Yes	Yes	①

Notes:

- ① Best commercial practice.
- ② CK is a DLA Land and Maritime (formerly DSCC) part marking used to designate a Class K compliant hybrid.  
The CK marking does not indicate the hybrid is radiation certified.  
No Suffix is a radiation rated device but not available as a DLA Land and Maritime qualified SMD per MIL-PRF-38534.  
International Rectifier currently does not have a DLA Land and Maritime certified Radiation Hardness Assurance Program.

**Part Numbering**

