



# S3ABF THRU S3MBF

## Surface Mount Standard Rectifiers

Reverse Voltage - 50 to 1000 V

Forward Current - 3 A

### FEATURES

- For surface mounted applications
- Low profile package
- Glass Passivated Chip Junction
- Easy to pick and place
- Lead free in comply with EU RoHS 2011/65/EU directives

### MECHANICAL DATA

- Case: SMBF
- Terminals: Solderable per MIL-STD-750, Method 2026
- Approx. Weight: 57mg / 0.002oz

### PINNING

| PIN | DESCRIPTION |
|-----|-------------|
| 1   | Cathode     |
| 2   | Anode       |

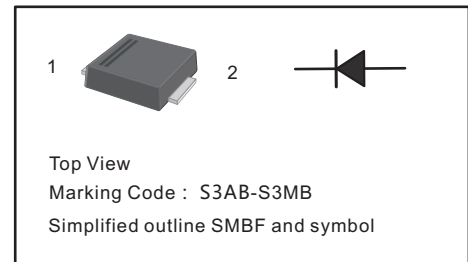

### Maximum Ratings and Electrical characteristics

Ratings at 25 °C ambient temperature unless otherwise specified.

Single phase half-wave 60 Hz, resistive or inductive load, for capacitive load current derate by 20 %.

| Parameter  | Symbols         | S3ABF      | S3BBF | S3DBF | S3GBF | S3JBF | S3KBF | S3MBF | Units              |
|--|-----------------|------------|-------|-------|-------|-------|-------|-------|--------------------|
| Maximum Repetitive Peak Reverse Voltage  | $V_{RRM}$       | 50         | 100   | 200   | 400   | 600   | 800   | 1000  | V                  |
| Maximum RMS voltage  | $V_{RMS}$       | 35         | 70    | 140   | 280   | 420   | 560   | 700   | V                  |
| Maximum DC Blocking Voltage  | $V_{DC}$        | 50         | 100   | 200   | 400   | 600   | 800   | 1000  | V                  |
| Maximum Average Forward Rectified Current at $T_a = 65^\circ\text{C}$  | $I_{F(AV)}$     | 3          |       |       |       |       |       |       | A                  |
| Peak Forward Surge Current 8.3 ms Single Half Sine Wave Superimposed on Rated Load (JEDEC Method)                | $I_{FSM}$       | 100        |       |       |       |       |       |       | A                  |
| Maximum Instantaneous Forward Voltage at 3 A   | $V_F$           | 1.1        |       |       |       |       |       |       | V                  |
| Maximum DC Reverse Current at Rated DC Blocking Voltage<br>$T_a = 25^\circ\text{C}$<br>$T_a = 125^\circ\text{C}$ | $I_R$           | 5<br>200   |       |       |       |       |       |       | $\mu\text{A}$      |
| Typical Junction Capacitance <sup>1)</sup>   | $C_j$           | 45         |       |       |       |       |       |       | pF                 |
| Typical Thermal Resistance <sup>2)</sup>   | $R_{\theta JA}$ | 40         |       |       |       |       |       |       | $^\circ\text{C/W}$ |
| Operating and Storage Temperature Range  | $T_j, T_{stg}$  | -55 ~ +150 |       |       |       |       |       |       | $^\circ\text{C}$   |

1) Measured at 1 MHz and applied reverse voltage of 4 V D.C

2) P.C.B. mounted with 0.5 X 0.5" (12.7 X 12.7 mm) copper pad areas.



# S3ABF THRU S3MBF Surface Mount Standard Rectifiers

## Characteristic Curves ( $T_A=25\text{ }^\circ\text{C}$ unless otherwise noted)

Fig.1 Forward Current Derating Curve

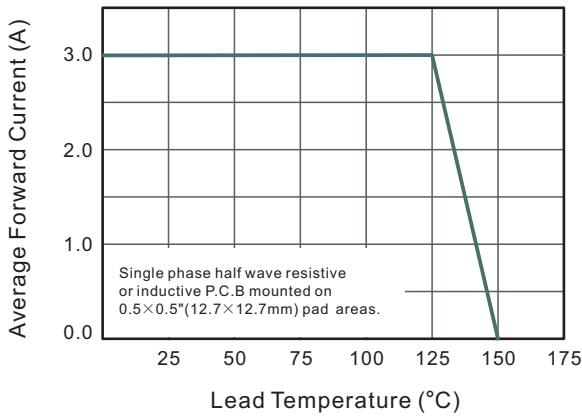

Fig.2 Typical Reverse Characteristics

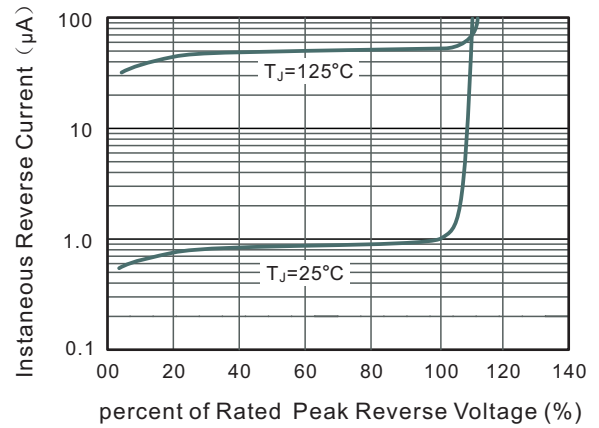

Fig.3 Typical Instantaneous Forward Characteristics

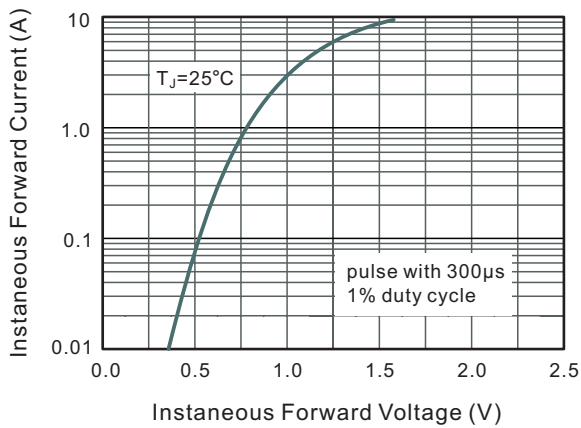

Fig.4 Typical Junction Capacitance

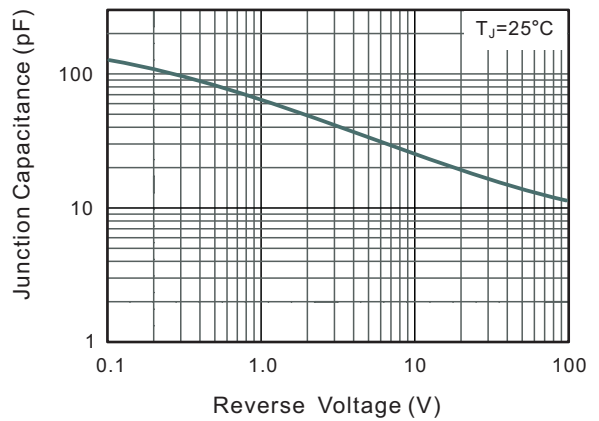
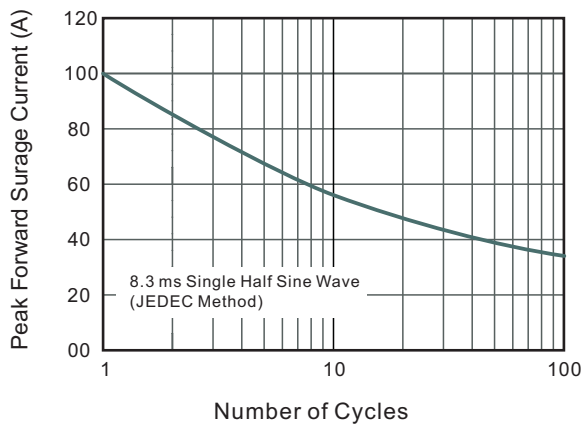

Fig.6 Maximum Non-Repetitive Peak Forward Surge Current





# S3ABF THRU S3MBF Surface Mount Standard Rectifiers

## PACKAGE OUTLINE

Plastic surface mounted package; 2 leads

SMBF

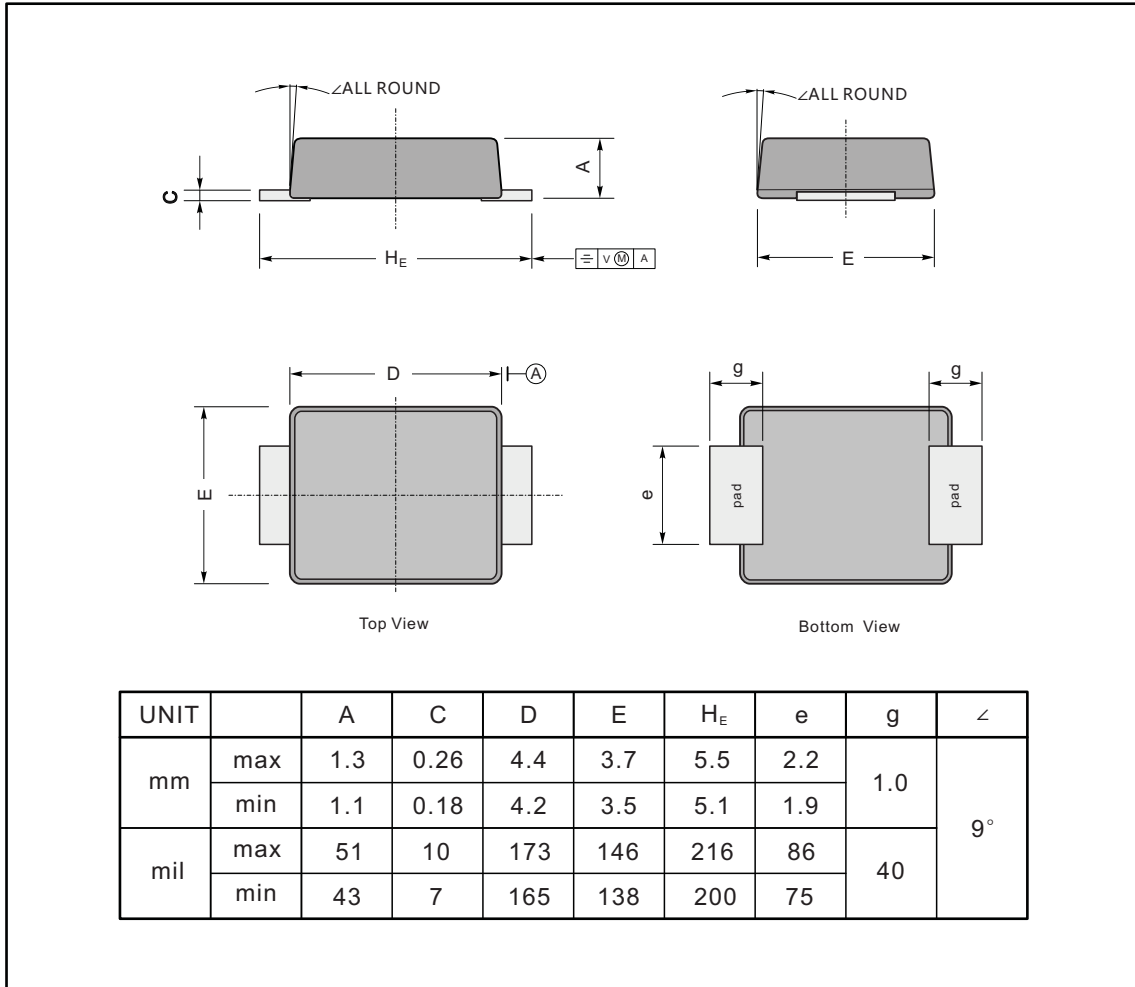

### The recommended mounting pad size

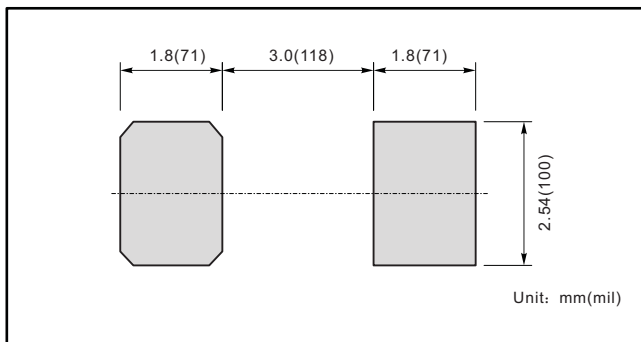

### Marking

| Type number | Marking code |
|-------------|--------------|
| S3ABF       | S3AB         |
| S3BBF       | S3BB         |
| S3DBF       | S3DB         |
| S3GBF       | S3GB         |
| S3JBF       | S3JB         |
| S3KBF       | S3KB         |
| S3MBF       | S3MB         |